

HardieTrim® **HT10** NT3™

4/4 & 5/4 Boards with Back Grooves

INSTALLATION REQUIREMENTS - PRIMED & COLORPLUS® PRODUCTS



EFFECTIVE FEBRUARY 2011

Visit www.jameshardie.com for the most recent version.

IMPORTANT: FAILURE TO INSTALL AND FINISH THIS PRODUCT IN ACCORDANCE WITH APPLICABLE BUILDING CODES AND JAMES HARDIE WRITTEN APPLICATION INSTRUCTIONS MAY LEAD TO PERSONAL INJURY, AFFECT SYSTEM PERFORMANCE, VIOLATE LOCAL BUILDING CODES, AND VOID THE PRODUCT ONLY WARRANTY. BEFORE INSTALLATION, CONFIRM THAT YOU ARE USING THE CORRECT HARDIEZONE INSTRUCTIONS.

TO DETERMINE WHICH HARDIEZONE APPLIES TO YOUR LOCATION, VISIT WWW.HARDIEZONE.COM OR CALL 1-866-942-7343 (866 9HARDIE)

STORAGE & HANDLING:

Store flat and keep dry and covered prior to installation. Installing siding wet or saturated may result in shrinkage at butt joints. Carry product on edge. Protect edges and corners from breakage. James Hardie is not responsible for damage caused by improper storage and handling of the product.

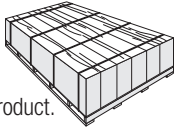

CUTTING INSTRUCTIONS

OUTDOORS

1. Position cutting station so that wind will blow dust away from user and others in working area.
2. Use one of the following methods:
 - b. Better:
 - i. Dust reducing circular saw equipped with a HardieBlade® saw blade and HEPA vacuum extraction
 - c. Good:
 - i. Dust reducing circular saw with a HardieBlade saw blade (only use for low to moderate cutting)

INDOORS

- NEVER use a power saw indoors
- NEVER use a circular saw blade that does not carry the HardieBlade saw blade trademark
- NEVER dry sweep – Use wet suppression or HEPA Vacuum

Important Note: For maximum protection (lowest respirable dust production), James Hardie recommends always using "Best"-level cutting methods where feasible.

NIOSH-approved respirators can be used in conjunction with above cutting practices to further reduce dust exposures. Additional exposure information is available at www.jameshardie.com to help you determine the most appropriate cutting method for your job requirements. If concern still exists about exposure levels or you do not comply with the above practices, you should always consult a qualified industrial hygienist or contact James Hardie for further information. SD083105

HardieTrim® NT3™ board is a decorative non-load bearing trim product.

GENERAL REQUIREMENTS:

- Wood or steel backing must be provided for attaching HardieTrim® NT3™ boards and the HardieTrim™ Flat Tabs. Additional framing may be required to ensure the HardieTrim™ Flat and Corner Tabs are fastened properly to the structure. Special attention should be paid to the framing when using a sheathing that does not have fastener holding equivalent to OSB or Plywood sheathing.
- A water-resistive barrier is required in accordance with local building code requirements. The water-resistive barrier must be appropriately installed with penetration and junction flashing in accordance with local building code requirements. James Hardie will assume no responsibility for water infiltration. James Hardie does manufacture HardieWrap® Weather Barrier, a non-woven non-perforated housewrap¹, which complies with building code requirements.
- Adjacent finished grade must slope away from the building in accordance with local building codes - typically a minimum of 6" in the first 10'.
- Flashing is required over horizontal protruding and exposed trim.
- Do not install James Hardie® products such that they may remain in contact with standing water.
- DO NOT use stain on James Hardie products.

INSTALLATION

Fastener Requirements

For Corners, Band Boards, Windows, and Door Applications:

HardieTrim NT3 boards with back grooves are installed with HardieTrim™ Flat Tabs (JH sku no. 280154) and HardieTrim™ Corner Tabs (JH sku no. 280155) which provide concealed fastening. Only HardieTrim Flat and Corner Tabs can be used with HardieTrim NT3 boards to create a concealed fastening.

- Step 1:** Attach HardieTrim Flat Tabs to the back side of the trim using four(4) 18 ga. 1/2" x 1/4" narrow crown galvanized staples using a pneumatic staple gun. The nail line on the tabs provide a guide for fastening the staples. (Figure 1)
- Step 2:** For wood frame construction, attach the trim to the building with minimum 6d siding nails fastened through the HardieTrim Flat Tabs (Figures 2 & 3) *. ET&F or equivalent fasteners may be used to attach the HardieTrim Flat Tabs to steel frame construction. (Figures 2 & 3)

Fastener spacing will vary based on application. Refer to specific sections in these instructions for required fastener spacing by application (window, band board, etc.)

HardieTrim® NT3 boards can also be installed in a more traditional fashion with finish nails. Use minimum 16 ga. 2" galvanized finish nails spaced at 16" o.c. to attach the trim.

For Fascia, Rake, and Frieze board Applications:

For fascia, rake, and frieze board applications, use minimum 16 ga. 2" galvanized finish nails to attach the HardieTrim NT3™ boards. Position finish nails no closer than 1/2" from the edges and no closer than 1" from the ends of the trim. Fasteners may be spaced at a maximum of 16" o.c. Ensure trim is adequately fastened.

James Hardie recommends using stainless steel finish nails when installing HardieTrim NT3 boards.

HardieTrim NT3 boards with ColorPlus® Technology: Remove the laminate sheet as soon as possible after attaching the trim to the building.

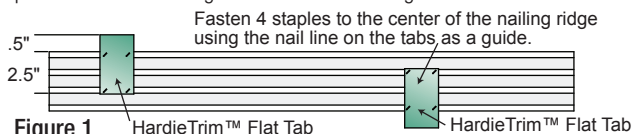

Figure 1

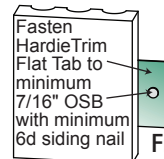

Figure 2

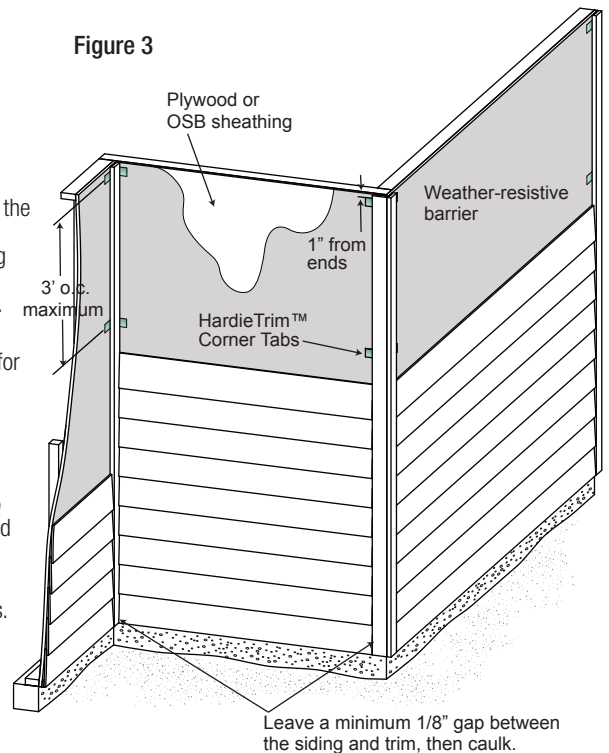

Figure 3

¹For additional information on HardieWrap® Weather Barrier, consult James Hardie at 1-866-4Hardie or www.hardiewrap.com

WARNING: AVOID BREATHING SILICA DUST

James Hardie® products contain respirable crystalline silica, which is known to the State of California to cause cancer and is considered by IARC and NIOSH to be a cause of cancer from some occupational sources. Breathing excessive amounts of respirable silica dust can also cause a disabling and potentially fatal lung disease called silicosis, and has been linked with other diseases. Some studies suggest smoking may increase these risks. During installation or handling: (1) work in outdoor areas with ample ventilation; (2) use fiber cement shears for cutting or, where not feasible, use a HardieBlade® saw blade and dust-reducing circular saw attached to a HEPA vacuum; (3) warn others in the immediate area; (4) wear a properly-fitted, NIOSH-approved dust mask or respirator (e.g. N-95) in accordance with applicable government regulations and manufacturer instructions to further limit respirable silica exposures. During clean-up, use HEPA vacuums or wet cleanup methods - never dry sweep. For further information, refer to our installation instructions and Material Safety Data Sheet available at www.jameshardie.com or by calling 1-800-9HARDIE (1-800-942-7343). FAILURE TO ADHERE TO OUR WARNINGS, MSDS, AND INSTALLATION INSTRUCTIONS MAY LEAD TO SERIOUS PERSONAL INJURY OR DEATH.

SD059905

TRIMMING CORNERS

HardieTrim® NT3™ boards with back grooves are installed around corners by pre-building the corner off the wall with the HardieTrim™ Corner Tabs (JH sku no. 280155).

- Attach HardieTrim Corner Tabs to the back side of the trim using eight(8) - 18 ga. 1/2" x 1/4" narrow crown galvanized staples using a pneumatic stapler. Ensure the HardieTrim Corner Tabs are fastened tight and straight to the trim boards. (Figure 4)
- For wood frame construction, attach trim to building using min. 6d siding nails fastened through the HardieTrim Corner Tabs attached to minimum 7/16" OSB* (Figure 5)
- Attach a HardieTrim Corner Tab 1" from each ends and every 3' o.c.
- TIP: Creating a jig for the work station is recommended to ensure corners are fastened securely and straight. (Figure 7)

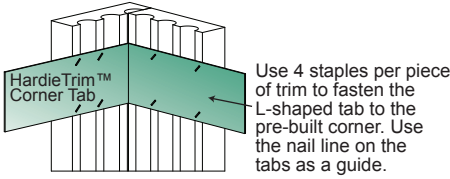

Figure 4

Use 4 staples per piece of trim to fasten the L-shaped tab to the pre-built corner. Use the nail line on the tabs as a guide.

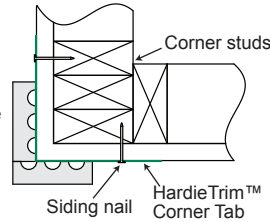

Figure 5

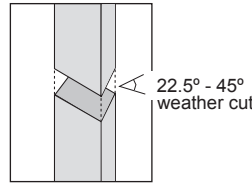

Figure 6

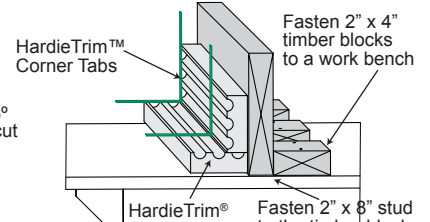

Figure 7

HardieTrim NT3™ boards with back grooves can also be installed directly to the building corners using minimum 16 ga. 2" galvanized finish nails 16" o.c.

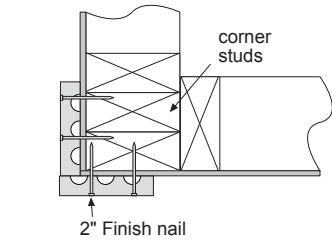

Figure 8

CLEARANCES

When installing James Hardie® products, all clearance details need to be followed. Install siding and trim products in compliance with local building code requirements for clearance between the bottom edge of the siding and the adjacent finished grade.

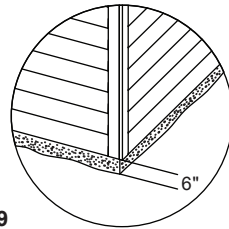

Figure 9

Maintain a minimum 1" - 2" clearance between James Hardie® trim products and decks, paths, steps and driveways.

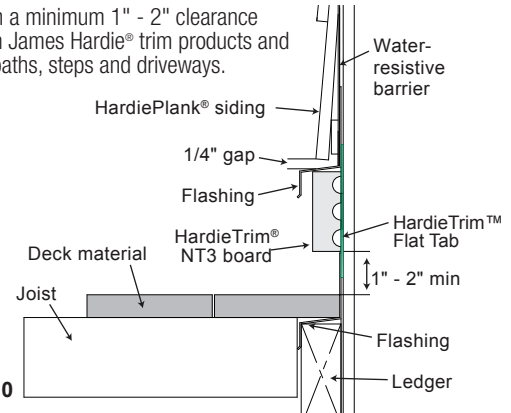

Figure 10

At the juncture of the roof and vertical surfaces, flashing and counterflashing shall be installed per the roofing manufacturer's instructions. Provide a 1"-2" clearance between the roofing and the bottom edge of the trim.

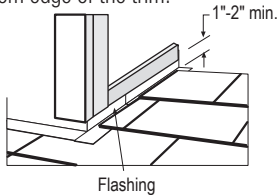

Figure 11

Maintain a 1/4" clearance between the bottom of James Hardie® products and horizontal flashing. Do not caulk gap.

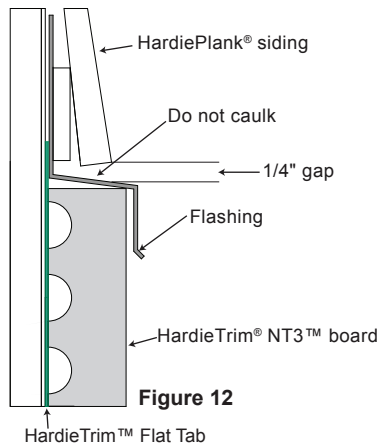

Figure 12

Maintain a minimum 1" gap between gutter end caps and siding & trim.

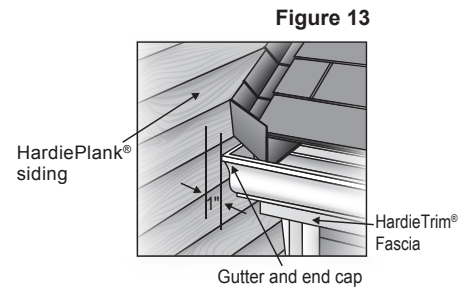

Figure 13

VALLEY FLASHING

The valley flashing must extend a minimum 1"-2" past the HardieTrim® Fascia and 6" to either side. If the valley flashing has been cut flush with the roofing, an additional valley flashing extension must be installed. If rain gutter is present and roof shingles extend 1" past fascia, a valley flashing extension is not required.

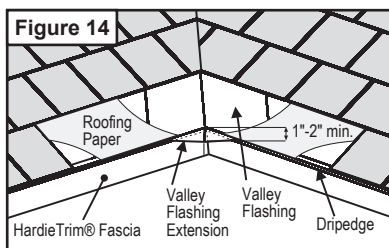
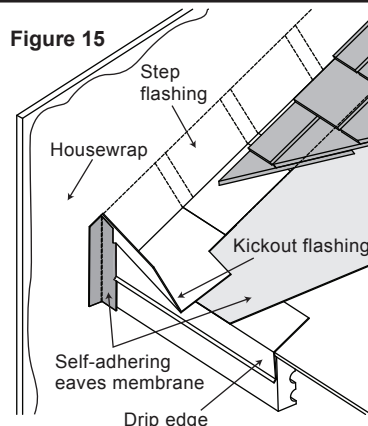

Figure 14

Figure 15



KICKOUT FLASHING

Because of the volume of water that can pour down a sloped roof, one of the most critical flashing details occurs where a roof intersects a sidewall. The roof must be flashed with step flashing. Where the roof terminates, install a kickout to deflect water away from the siding.

It is best to install a self-adhering membrane on the wall before the subfascia and trim boards are nailed in place, and then come back to install the kickout.

Figure 15, Kickout Flashing To prevent water from dumping behind the siding and the end of the roof intersection, install a "kickout" of sufficient length and angle to direct the water running down the roof away from the siding.

TRIM APPLICATION FOR WINDOWS, DOORS & OTHER OPENINGS

Trim the opening prior to the installation of the siding (Figure 16).

For openings less than 4' in size, place a HardieTrim™ Flat Tab at the end of each trim board and one tab in the center of each trim. Attach the trim boards and HardieTrim™ Flat Tabs around the opening as shown in Figures 15 and 16. Use 16 ga. galvanized 2" finish nails to ensure proper fastening if needed.

For openings greater than 4' in size, place a HardieTrim™ Flat Tab at the end of each trim board and one tab for each framing member at a maximum of 24" o.c. Attach the trim boards and HardieTrim™ Flat Tabs around the opening as shown in Figures 16 and 17. Use 16 ga. galvanized 2" long finish nails to ensure proper fastening if needed.

Figure 16

Side trim pieces go to the top of the window.



Bottom trim piece is the width of the window.

Figure 17

Header piece spans the window including the side trim pieces.

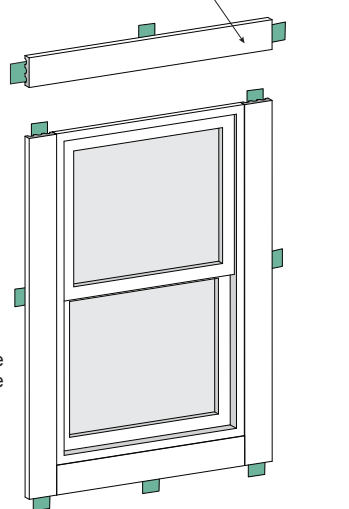

NOTE: Follow your window/door manufacturers installation instructions.

Flashing needs to be tucked under the water resistive barrier and over the HardieTrim™ Flat Tabs.

Do not caulk between the siding and the flashing.

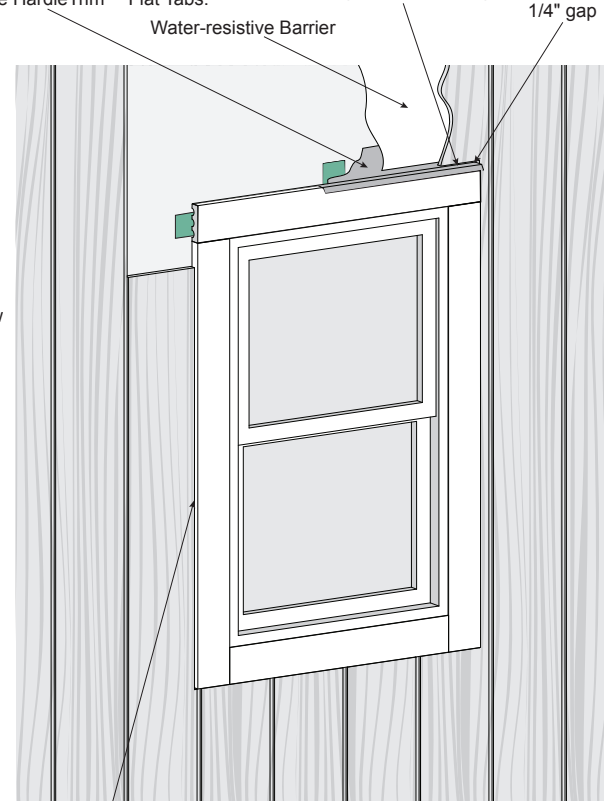

1/8" caulked gap is left between siding and the side trim pieces.

Figure 18

BAND BOARDS, FRIEZE BOARDS, RAKE TRIM & FASCIA

HardieTrim® NT3 boards may also be used as band boards, frieze boards, rake trim or fascia (Figure 19).

Figure 19

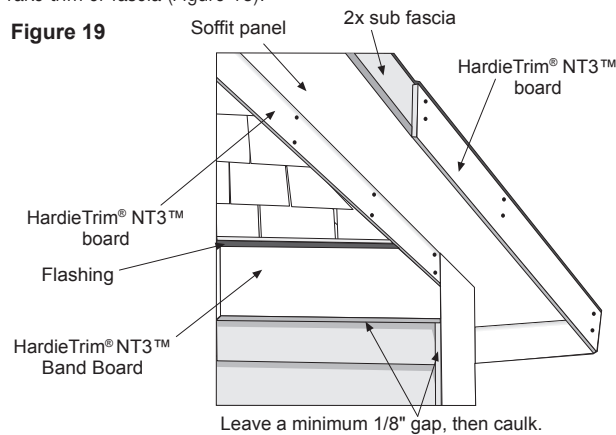

Leave a minimum 1/8" gap, then caulk.

FRIEZE BOARDS

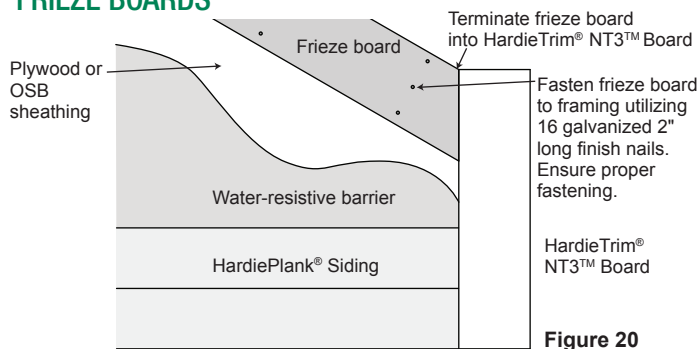
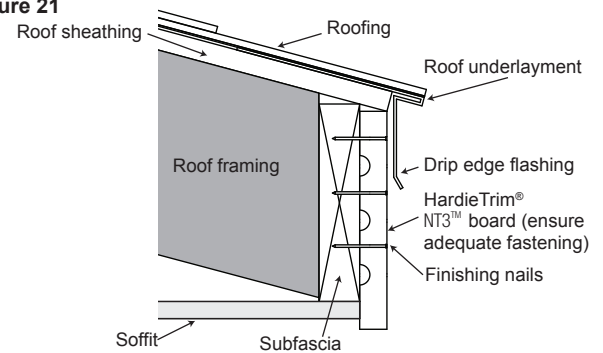

Figure 20

FASCIA & RAKE

For fascia and rake applications, a flashing is required over top of the fascia (Figure 21).

Figure 21



**Figure 22
Birdhouse Detail**

Ensure that all birdhouse trim is adequately fastened to a solid substrate.

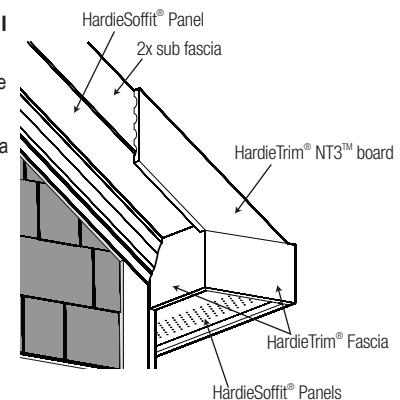

BAND BOARD

A flashing is required over the trim and HardieTrim™ Flat Tabs. (Figure 23) Terminate ends of the Band Board into Trim or Siding or miter cut the edges of the trim at the corners of the building. Place a HardieTrim™ Flat Tab at the end of each trim board and one tab every stud at a maximum of 24" o.c. The HardieTrim™ Flat Tabs should be attached to the trim in an alternating pattern to the top and bottom of the band board (Figure 24, 25). Use 16 ga. galvanized 2" long finish nails to ensure proper fastening if needed.

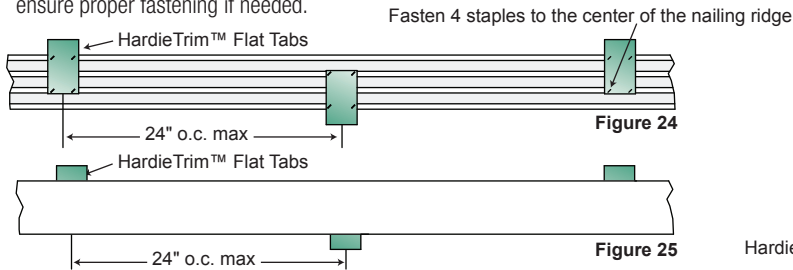
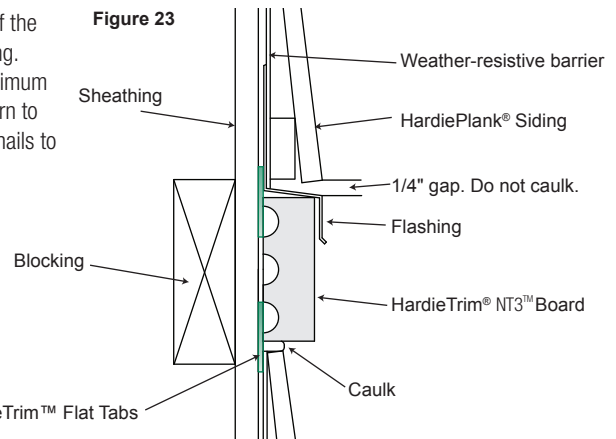

Figure 23



GENERAL FASTENING REQUIREMENTS

Fasteners must be corrosion resistant, galvanized, or stainless steel. Electro-galvanized are acceptable but may exhibit premature corrosion. James Hardie recommends the use of quality, hot-dipped galvanized fasteners. James Hardie is not responsible for the corrosion resistance of fasteners. Stainless steel fasteners are recommended when installing James Hardie® products near the ocean, large bodies of water, or very humid climates.

PNEUMATIC FASTENING:

HardieTrim® NT3™ boards with the back groove can be fastened with a pneumatic tool. All fasteners should be driven flush to the HardieTrim™ Flat and Corner Tabs (Figure 26). A flush mount attachment on the pneumatic tool is recommended. This will help control the depth the fastener is driven. If setting the depth proves difficult, choose a setting that under drives the fastener. (Drive under driven fasteners snug with a smooth faced hammer - Does not apply for installation to steel framing).

- Drive fasteners perpendicular to the trim and framing.
- Do not drive fasteners at an angle.
- For wood framing, under driven fasteners should be hit flush to the HardieTrim™ Flat and Corner Tabs with a hammer (for steel framing, remove and replace nail).
- **Do not use aluminum fasteners, staples, or clipped head nails to attach the product directly to the building.**

Figure 26

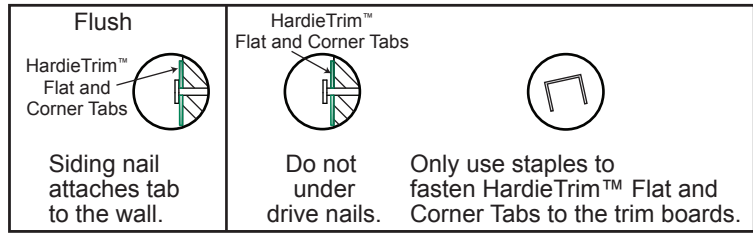

CUT EDGE TREATMENT

Caulk, paint or prime all field cut edges.

CAULKING

For best results use an Elastomeric Joint Sealant complying with ASTM C920 Grade NS, Class 25 or higher or a Latex Joint Sealant complying with ASTM C834. Caulking/Sealant must be applied in accordance with the caulking/sealant manufacturer's written instructions or ASTM C1193.

PAINTING

DO NOT use stain on James Hardie® products. James Hardie products must be painted within 180 days for primed product and 90 days for unprimed. 100% acrylic topcoats are recommended. Do not paint when wet. For application rates refer to paint manufacturers specifications. Back-rolling is recommended if the siding is sprayed.

COLORPLUS® TECHNOLOGY CAULKING, TOUCH-UP & LAMINATE

- Touch up nicks, scrapes and nail heads using the ColorPlus® Technology touch-up applicator. Touch-up paint should be used sparingly. If large areas require touch-up, replace the damaged area with new HardieTrim NT3™ board with ColorPlus Technology.
- Laminate sheet must be removed immediately after installation of each trim board.
- Terminate non-factory cut edges into trim where possible, and caulk. Color matched caulks are available from your ColorPlus® product dealer.
- Treat all other non-factory cut edges using the ColorPlus Technology edge coaters, available from your ColorPlus product dealer.

PAINTING JAMES HARDIE® SIDING AND TRIM PRODUCTS WITH COLORPLUS® TECHNOLOGY

When repainting ColorPlus® products, James Hardie recommends the following regarding surface preparation and topcoat application:

- Ensure the surface is clean, dry, and free of any dust, dirt, or mildew
- Repriming is normally not necessary
- 100% acrylic topcoats are recommended
- DO NOT use stain or oil/alkyd based paints
- Apply finish coat in accordance with paint manufacturers written instructions regarding coverage, application methods, and application temperature

RECOGNITION: HardieTrim NT3™ boards may be installed as an equal alternative to conventional trim permitted for use in; the 2003 International Residence Code for One - and Two - Family - Dwellings, Section R703.1. the 2003 International Residence Code for One - and Two - Family - Dwellings, Section R703.1.