

# IRONHAUS

Handcrafted Fireplace Systems

## The Yellowstone

Direct Vent Gas Fireplace



Shown in European Style

**THE YELLOWSTONE** Direct Vent gas fireplace is the perfect centerpiece for your home. A huge "Rumford" Style firebox, tall flame, and true handcrafted fireplace screens are sure to fit your oversized direct vent applications. Thoughtful design and impeccable quality are the obvious results from the dedicated artisans at **IRONHAUS**.

- *36" w x 47" h Opening*
- *66,000 BTU Dual Burner System*
- *Concealed Electronic Ignition & Control System*
- *Separate Outside Combustion Air Feature*
- *Style Coordinates With All IRONHAUS Products*

# The Yellowstone - Features

Face can be set aside until construction is complete

Hand-grouted Refractory Panels

Available in Natural Gas or Propane



Choose From 7 Different Face Styles.

Match to other IRONHAUS fireplaces in your home

66,000 BTU Realistic Gas Logs

How to Order:

- 1) Determine Natural Gas or LP and design style.
- 2) Choose finish.
- 3) Verify install and venting requirements with your dealer or builder.
- 4) Place order with dealer or online at [www.ironhaus.com](http://www.ironhaus.com).



Santa Fe Style  
Y6 - \*NT/BP/BC/RT



Mountain Style  
Y3 - \*NT/BK/BC



Craftsman  
Y1 - \*NT/BC/

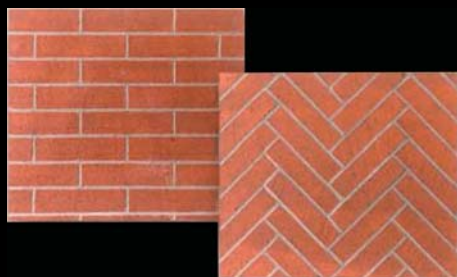

Comes Standard with Herringbone Refractory Panels. Stacked Brick Refractory Panels are Optional.

# The Yellowstone - Styles & Finishes



Fullview Style  
Y5 - \*BP/RT/NT/BC/DB/BK



European Style  
Y7 - \*NT/BP/DB/BC



Man Style  
Y6 - \*BC/BK/DB



Mediterranean Style  
Y4 - \*NT/DB/BC/RT



Old World Style  
Y2 - \*NT/BP/RT/BC

\*Designs are designated for available finishes. For alternate customizations contact IRONHAUS at [www.ironhaus.com](http://www.ironhaus.com) or contact your Dealer.



BC - Distressed Black Copper



NT - Distressed Natural



BP - Distressed Buff Pewter



RT - Distressed Rust



DB - Distressed Dark Bronze



BK - Distressed Black

# The Yellowstone - Specifications

Vent Opening  
(Noncombustible Wall)

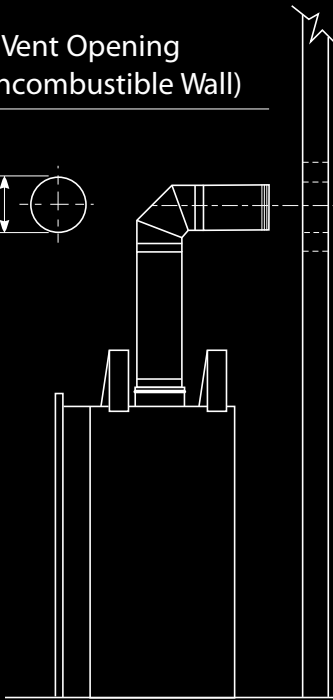
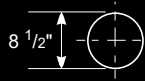

Vent Opening  
(Combustible Wall)

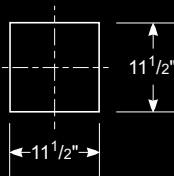

Framing Details

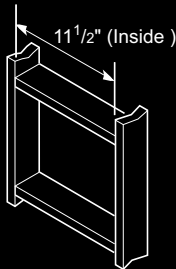

Outside Air Framing

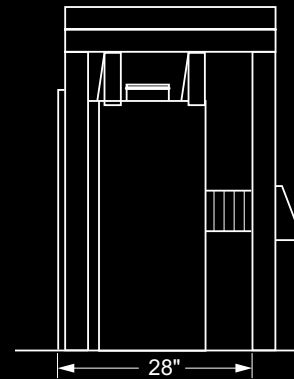
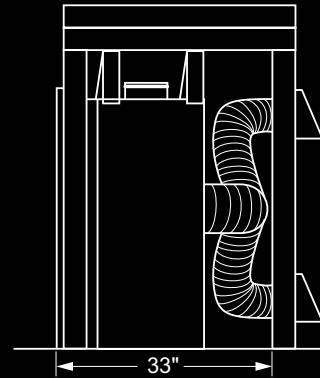

Standard Installation

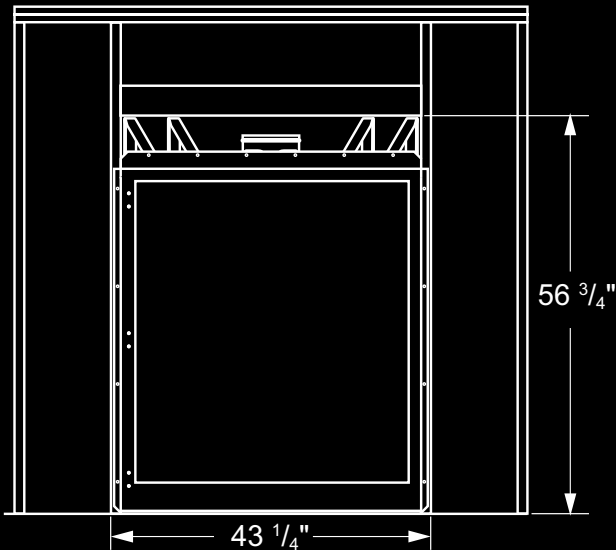

Corner Installation

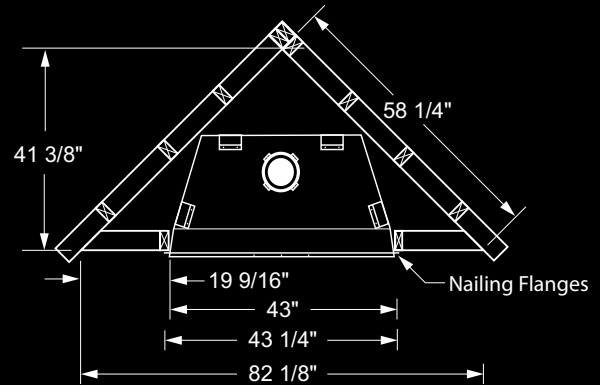

NOTE: Outside (combustion) Air Kit may be installed on an outside wall, in a chase, or a vented crawl space.

For more information or dealer locations please visit us on the web or contact us.

IRONHAUS, Inc.

113 Lewis LN, Hamilton, MT 59840

1.866.880.0900 406.961.1800 406.961.1801 fax www.ironhaus.com