

ELKAY[®]

SPECIFICATIONS

Soap/Lotion Dispenser LK313, LK323 and LK333 Series

GENERAL

Deluxe plunger type dispenser for liquid soap or hand lotion. Plastic concealed 1/2 pint container fills from top. 2-15/16" (74mm) high pump. Spout reach is 2-15/16" (74mm).

MODELS

LK313 Series - Requires 1 faucet hole for installation. Ship. Wt. 2 lbs.

LK313CR Chrome plated.

LK313AL Almond epoxy.

LK313BK Glossy black epoxy.

LK313NK Brushed nickel.

LK313WH White epoxy.

LK323 Series - Requires 1 faucet hole for installation. Ship. Wt. 2 lbs.

LK323AC Antique copper.

LK323CR Chrome plated.

LK323MC Polished mirrored copper.

LK333 Series - Requires 1 faucet hole for installation. Ship. Wt. 2 lbs.

LK333CR Chrome plated.

LK333NK Brushed nickel.

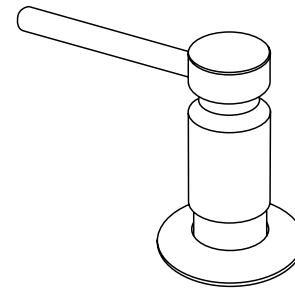

Model LK313

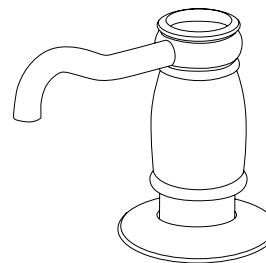

Model LK323

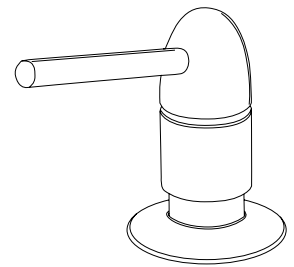

Model LK333

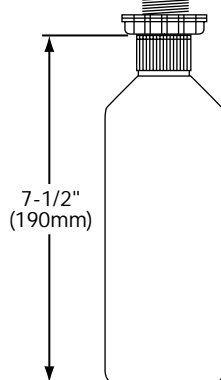
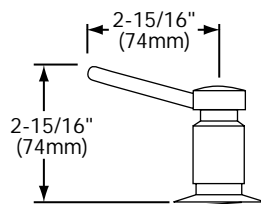

LK313 Illustrated

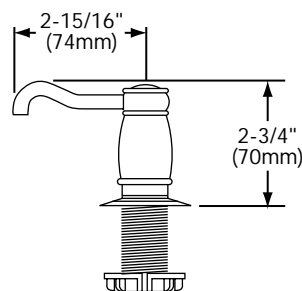

LK323 Illustrated

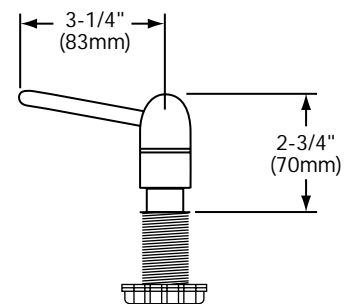

LK333 Illustrated