

COMBOLIGHT

Combo Classic

Recessed Series

COMBOLIGHT® Combo Classic™

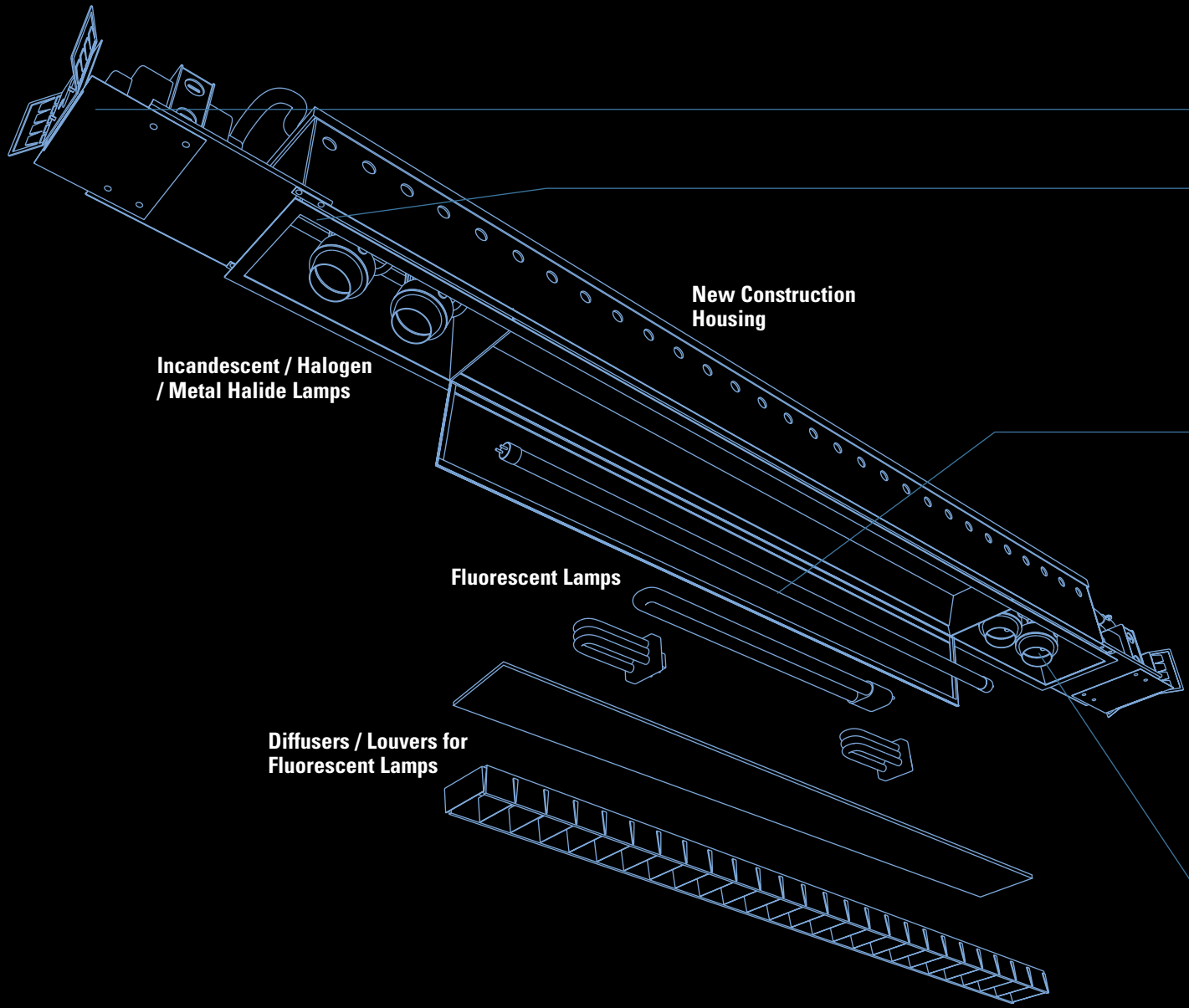

Available with a 3/4" trim or as a trimless fixture

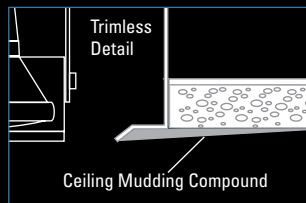
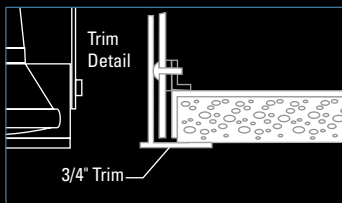

Recessed Mount

- Standard Combolight Recessed fixtures with the ability to mix various types of halogen, incandescent and metal halide lamps with a variety of fluorescent lamps
- Suitable for new construction installations
- Available with 3/4" ceiling trim or as a trimless fixture
- Available in many standard configurations for easy ordering. Custom configurations are available - contact the RSA factory for details
- Available lamps include:

MR16	BIAX™
AR70	PLT
AR111	T5
PAR20	T5HO
PAR20MH	
PAR30	
PAR30MH	
PAR38	
PAR38MH	
T4 G8.5MH	
- Available with integral power supplies (low voltage electronic transformers or Aromat metal halide ballasts)
- Standard locking adjustable yoke lamp holders adjust 380° x 90° with positive locking mechanism (for non-fluorescent lamps)
- Fixture is comprised of sturdy steel construction with a durable powder coat finish inside and out

Incandescent, Metal Halide & Fluorescent Mixed Lamps

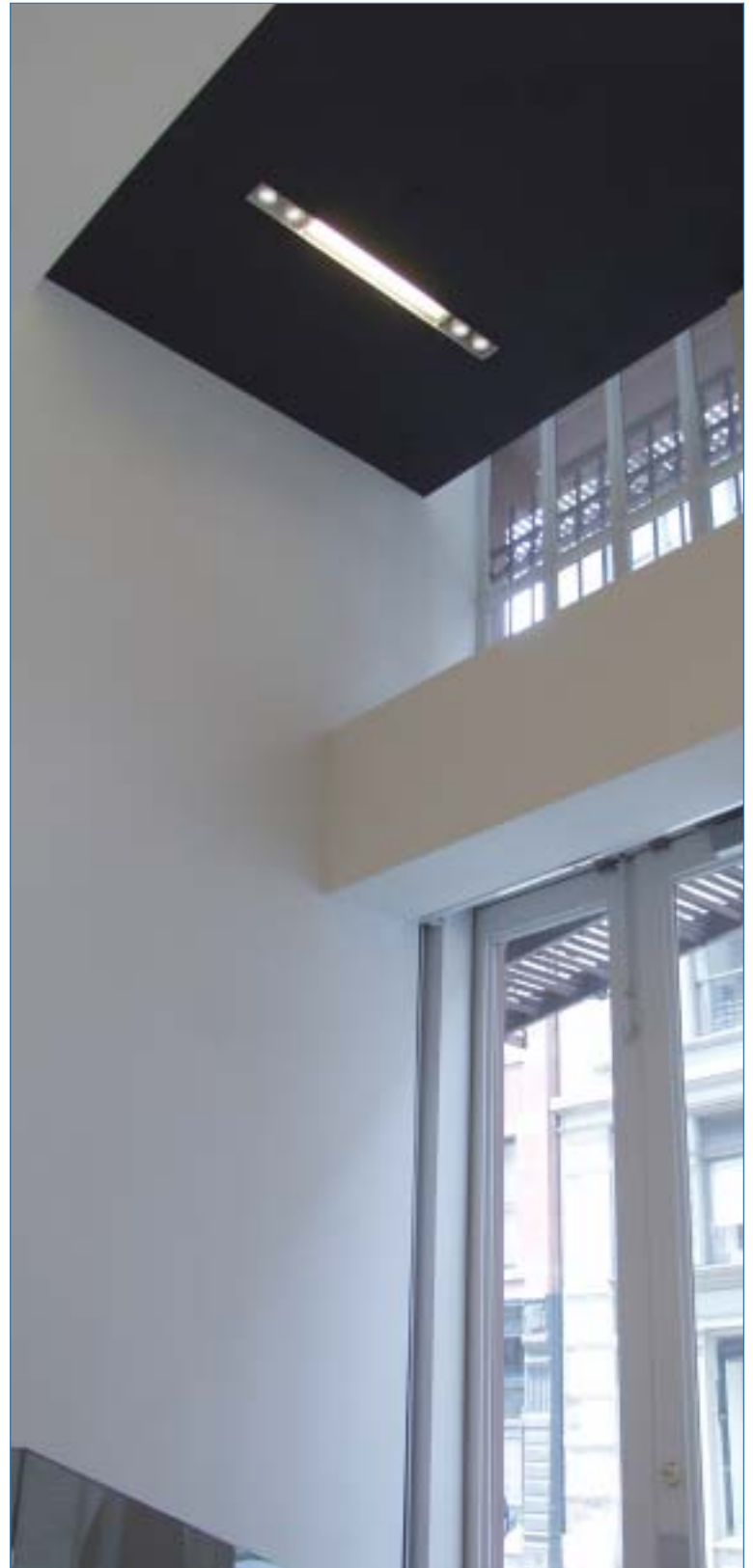



CR11650 A T5H039 BK WH 277 (Shown with parabolic louver and snout accessories)

COMBO CLASSIC RECESSED LOW VOLTAGE MR16

- Standard new construction fixture with 3/4" trim or trimless
- Combines the use of Low Voltage MR16 lamps with a choice of fluorescent lamp sources in many fixture configuration styles.

FIXTURE CONFIGURATIONS

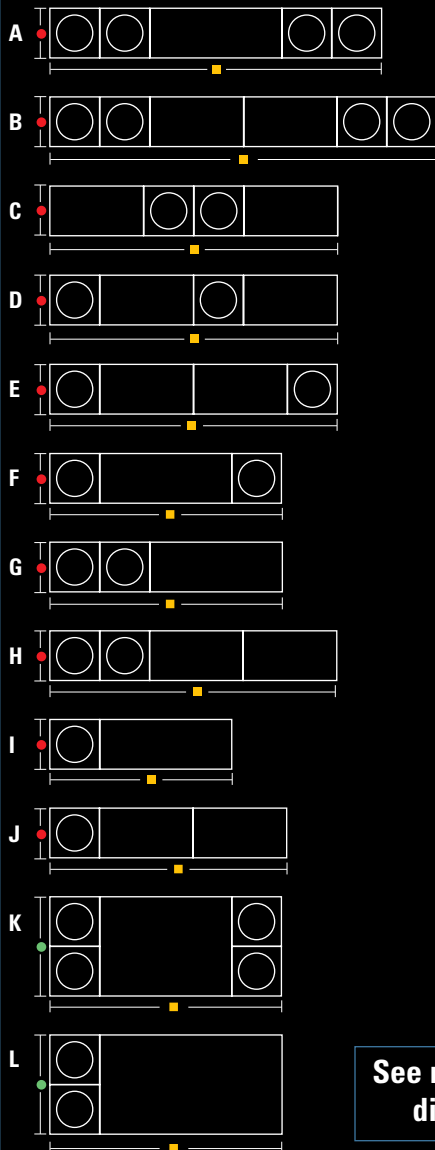

See next page for
dimensions

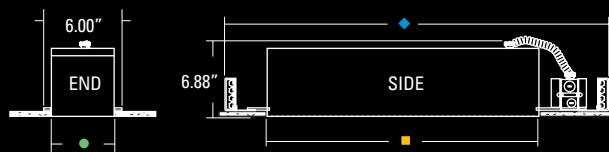

ORDERING

	Item #	Description
1 FIXTURE	CR11650	Combo Classic Recessed MR16 12 volt 50 watts
	CR11675	Combo Classic Recessed MR16 12 volt 75 watts

	Item #	Description
2 FIXTURE CONFIGURATION	A	4 Light MR16 with 1 Center Fluor. Cell
	B	4 Light MR16 with 2 Center Fluor. Cells
	C	2 Light MR16 with 2 Outer Fluor. Cells
	D	2 Light MR16 with 2 Alternate Fluor. Cells
	E	2 Light MR16 with 2 Center Fluor. Cells
	F	2 Light MR16 with 1 Center Fluor. Cell
	G	2 Light MR16 with 1 Fluor. Cell
	H	2 Light MR16 with 2 Fluor. Cells
	I	1 Light MR16 with 1 Fluor. Cell
	J	1 Light MR16 with 2 Fluor. Cells
	K	4 Light MR16 Double Wide with 2 Fluor. Cells
	L	2 Light MR16 Double Wide with 2 Fluor. Cells

	Item #	Description	Item #	Description
3 FLUORESCENT CELL	BX40	40 watt BIAX®	T528	28 watt T5
	BX50	50 watt BIAX®	T535	35 watt T5
	PLL80	80 watt PL-L	T5H039	39 watt T5HO
	PLT26	26 watt PL-T	T5H054	54 watt T5HO
	PLT32	32 watt PL-T		
	PLT42	42 watt PL-T		

	Item #	Description
4 INTERIOR	BK	Black
	WH	White
	S	Industrial Silver
	PT	Custom (Specify)

	Item #	Description
5 TRIM	BK	Black
	WH	White
	S	Industrial Silver
	PT	Custom (Specify)
	TR	Trimless (NO TRIM)

	Item #	Description
6 VOLTAGE	120	120 Volts
	277	277 Volts

Ordering Example

FIXTURE TYPE	FIXTURE CONFIGURATION	FLUORESCENT CELL	INTERIOR	TRIM	VOLTAGE
CR11650	A	T5H039	BK	WH	120

Combo Classic Recessed, Four light 50 Watt MR16 with One 39 Watt T5HO Cell, Black Interior, White Trim, 120 volts

- Standard new construction fixture offered with 3/4" trim or as a trimless fixture
- Plaster frame can accommodate 1/2" to 1" ceiling thickness
- Includes butterfly brackets for commercial installations
- Low voltage electronic transformer with fuse and short circuit protection





- Fluorescent cells available with a wide array of accessories such as high transmission overlays and parabolic louvers (see page 172)
- Custom configurations are available (Consult RSA Customer Service)
- Also available in Surface Mounted Models (see page 150 - 171)

COMBO CLASSIC MR16 RECESSED FIXTURE CONFIGURATION DIMENSIONS

MR16 Fixture Configuration		BX40	BX50	PLL80	PLT26	PLT32	PLT42	T528	T535	T5HO39	T5HO54
A 4 Light MR16 with 1 Center Fluor. Cell	●	4.30"	4.30"	4.30"	4.30"	4.30"	4.30"	4.30"	4.30"	4.30"	4.30"
	■	42.78"	42.78"	42.78"	25.28"	25.78"	26.78"	66.28"	78.28"	54.28"	66.28"
	◆	54.58"	54.58"	54.58"	37.08"	39.60"	38.58"	78.08"	90.08"	66.08"	78.08"
B 4 Light MR16 with 2 Center Fluor. Cells	●	4.30"	4.30"	4.30"	4.30"	4.30"	4.30"	4.30"	4.30"	4.30"	4.30"
	■	68.38"	68.38"	68.38"	33.38"	34.38"	36.38"	115.38"	139.38"	91.38"	115.38"
	◆	80.18"	80.18"	80.18"	45.18"	46.18"	48.18"	127.18"	151.18"	103.18"	127.18"
C 2 Light MR16 with 2 Outer Fluor. Cells	●	4.30"	4.30"	4.30"	4.30"	4.30"	4.30"	4.30"	4.30"	4.30"	4.30"
	■	59.78"	59.78"	59.78"	24.78"	25.78"	27.78"	106.78"	130.78"	82.78"	106.78"
	◆	71.58"	71.58"	71.58"	35.58"	40.08"	39.58"	118.58"	142.58"	94.58"	118.58"
D 2 Light MR16 with 2 Alternate Fluor. Cells	●	4.30"	4.30"	4.30"	4.30"	4.30"	4.30"	4.30"	4.30"	4.30"	4.30"
	■	59.78"	59.78"	59.78"	24.78"	25.78"	27.78"	106.78"	130.78"	82.78"	106.78"
	◆	71.58"	71.58"	71.58"	35.58"	40.08"	39.58"	118.58"	142.58"	94.58"	118.58"
E 2 Light MR16 with 2 Center Fluor. Cells	●	4.30"	4.30"	4.30"	4.30"	4.30"	4.30"	4.30"	4.30"	4.30"	4.30"
	■	59.78"	59.78"	59.78"	24.78"	25.78"	27.78"	106.78"	130.78"	82.78"	106.78"
	◆	71.58"	71.58"	71.58"	35.58"	40.08"	39.58"	118.58"	142.58"	94.58"	118.58"
F 2 Light MR16 with 1 Center Fluor. Cell	●	4.30"	4.30"	4.30"	4.30"	4.30"	4.30"	4.30"	4.30"	4.30"	4.30"
	■	34.19"	34.19"	34.19"	16.69"	17.19"	18.19"	57.69"	69.69"	45.69"	57.69"
	◆	45.99"	45.99"	45.99"	24.49"	28.99"	35.29"	69.49"	81.49"	57.49"	69.49"
G 2 Light MR16 with 1 Fluor. Cell	●	4.30"	4.30"	4.30"	4.30"	4.30"	4.30"	4.30"	4.30"	4.30"	4.30"
	■	34.19"	34.19"	34.19"	16.69"	17.19"	18.19"	57.69"	69.69"	45.69"	57.69"
	◆	45.99"	45.99"	45.99"	24.49"	28.99"	35.29"	69.49"	81.49"	57.49"	69.49"
H 2 Light MR16 with 2 Fluor. Cells	●	4.30"	4.30"	4.30"	4.30"	4.30"	4.30"	4.30"	4.30"	4.30"	4.30"
	■	59.78"	59.78"	59.78"	24.78"	25.78"	27.78"	106.78"	130.78"	82.78"	106.78"
	◆	71.58"	71.58"	71.58"	35.58"	40.08"	39.58"	118.58"	142.58"	94.58"	118.58"
I 1 Light MR16 with 1 Fluor. Cell	●	4.30"	4.30"	4.30"	4.30"	4.30"	4.30"	4.30"	4.30"	4.30"	4.30"
	■	29.89"	29.89"	29.89"	12.39"	12.89"	13.89"	53.39"	65.39"	41.39"	53.39"
	◆	39.69"	39.69"	39.69"	22.19"	22.69"	23.69"	63.19"	75.19"	51.19"	63.19"
J 1 Light MR16 with 2 Fluor. Cells	●	4.30"	4.30"	4.30"	4.30"	4.30"	4.30"	4.30"	4.30"	4.30"	4.30"
	■	55.49"	55.49"	55.49"	20.49"	21.49"	23.49"	102.49"	126.49"	78.49"	102.49"
	◆	67.29"	67.29"	67.29"	32.29"	33.29"	29.99"	114.29"	138.29"	90.29"	114.29"
K 4 Light MR16 Double Wide with 2 Fluor. Cells	●	8.59"	8.59"	8.59"	8.59"	8.59"	8.59"	8.59"	8.59"	8.59"	8.59"
	■	34.19"	34.19"	34.19"	16.69"	17.19"	18.19"	57.69"	69.69"	45.69"	57.69"
	◆	45.99"	45.99"	45.99"	24.49"	28.99"	35.29"	69.49"	81.49"	57.49"	69.49"
L 2 Light MR16 Double Wide with 2 Fluor. Cells	●	8.59"	8.59"	8.59"	8.59"	8.59"	8.59"	8.59"	8.59"	8.59"	8.59"
	■	29.89"	29.89"	29.89"	12.39"	12.89"	13.89"	53.39"	65.39"	41.39"	53.39"
	◆	39.69"	39.69"	39.69"	22.19"	22.69"	23.69"	63.19"	75.19"	51.19"	63.19"

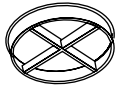
Optional Accessories - See page 216 for details.

For fluorescent accessories see page 172.

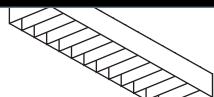
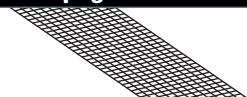
					
Baffle	Snoots	Louvers	Lenses	Parabolic Louvers	Diffusers



CR17050 C BX50 BK WH 120 (Shown with Textured White Diffusers)

COMBO CLASSIC RECESSED LOW VOLTAGE AR70

- Standard new construction fixture with 3/4" trim or trimless
- Combines the use of Low Voltage AR70 lamps with a choice of fluorescent lamp sources in many fixture configuration styles.

FIXTURE CONFIGURATIONS

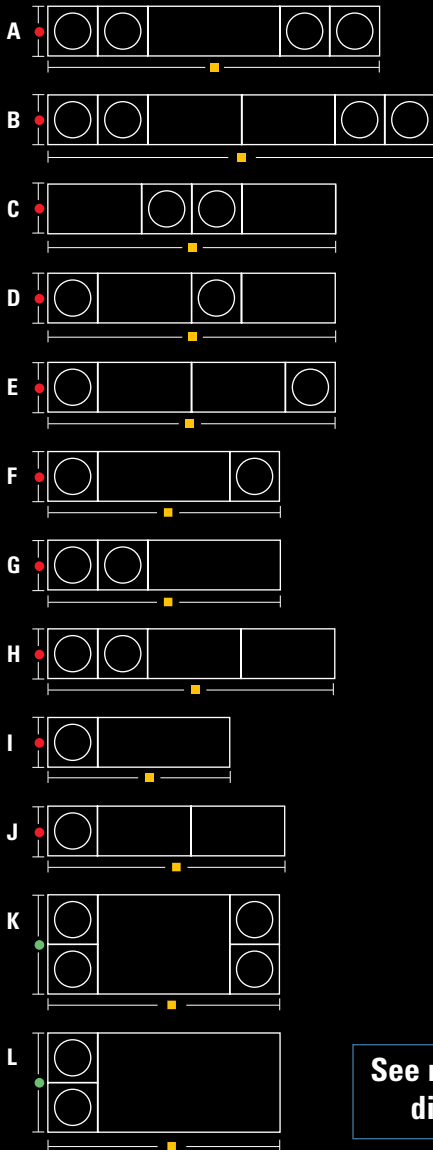

See next page for
dimensions

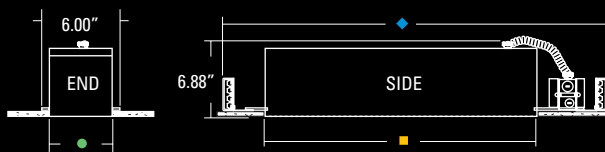

ORDERING

	Item #	Description
1 FIXTURE	CR17020	Combo Classic Recessed AR70 12 volt 20 watts
	CR17050	Combo Classic Recessed AR70 12 volt 50 watts

	Item #	Description
2 FIXTURE CONFIGURATION	A	4 Light AR70 with 1 Center Fluor. Cell
	B	4 Light AR70 with 2 Center Fluor. Cells
	C	2 Light AR70 with 2 Outer Fluor. Cells
	D	2 Light AR70 with 2 Alternate Fluor. Cells
	E	2 Light AR70 with 2 Center Fluor. Cells
	F	2 Light AR70 with 1 Center Fluor. Cell
	G	2 Light AR70 with 1 Fluor. Cell
	H	2 Light AR70 with 2 Fluor. Cells
	I	1 Light AR70 with 1 Fluor. Cell
	J	1 Light AR70 with 2 Fluor. Cells
	K	4 Light AR70 Double Wide with 2 Fluor. Cells
	L	2 Light AR70 Double Wide with 2 Fluor. Cells

	Item #	Description	Item #	Description
3 FLUORESCENT CELL	BX40	40 watt BIAX®	T528	28 watt T5
	BX50	50 watt BIAX®	T535	35 watt T5
	PLL80	80 watt PL-L	T5HO39	39 watt T5HO
	PLT26	26 watt PL-T	T5HO54	54 watt T5HO
	PLT32	32 watt PL-T		
	PLT42	42 watt PL-T		

	Item #	Description
4 INTERIOR	BK	Black
	WH	White
	S	Industrial Silver
	PT	Custom (Specify)

	Item #	Description
5 TRIM	BK	Black
	WH	White
	S	Industrial Silver
	PT	Custom (Specify)
	TR	Trimless (NO TRIM)

	Item #	Description
6 VOLTAGE	120	120 Volts
	277	277 Volts

Ordering Example

FIXTURE TYPE	FIXTURE CONFIGURATION	FLUORESCENT CELL	INTERIOR	TRIM	VOLTS
CR17050	C	BX50	BK	WH	120

Combo Classic Recessed, Two light 50 Watt AR70 with Two 50 Watt BIAX® Cells, Black Interior, White Trim, 120 volts

- Standard new construction fixture offered with 3/4" trim or as a trimless fixture
- Plaster frame can accommodate 1/2" to 1" ceiling thickness
- Includes butterfly brackets for commercial installations
- Low voltage electronic transformer with fuse and short circuit protection





- Fluorescent cells available with a wide array of accessories such as high transmission overlays and parabolic louvers (see page 172)
- Custom configurations are available (Consult RSA Customer Service)
- Also available in Surface Mounted Models (see page 150 - 171)

COMBO CLASSIC AR70 RECESSED FIXTURE CONFIGURATION DIMENSIONS

AR70 Fixture Configuration		BX40	BX50	PLL80	PLT26	PLT32	PLT42	T528	T535	T5HO39	T5HO54
A 4 Light AR70 with 1 Center Fluor. Cell	●	4.30"	4.30"	4.30"	4.30"	4.30"	4.30"	4.30"	4.30"	4.30"	4.30"
	■	42.78"	42.78"	42.78"	25.28"	25.78"	26.78"	66.28"	78.28"	54.28"	66.28"
	◆	54.58"	54.58"	54.58"	37.08"	39.60"	38.58"	78.08"	90.08"	66.08"	78.08"
B 4 Light AR70 with 2 Center Fluor. Cells	●	4.30"	4.30"	4.30"	4.30"	4.30"	4.30"	4.30"	4.30"	4.30"	4.30"
	■	68.38"	68.38"	68.38"	33.38"	34.38"	36.38"	115.38"	139.38"	91.38"	115.38"
	◆	80.18"	80.18"	80.18"	45.18"	46.18"	48.18"	127.18"	151.18"	103.18"	127.18"
C 2 Light AR70 with 2 Outer Fluor. Cells	●	4.30"	4.30"	4.30"	4.30"	4.30"	4.30"	4.30"	4.30"	4.30"	4.30"
	■	59.78"	59.78"	59.78"	24.78"	25.78"	27.78"	106.78"	130.78"	82.78"	106.78"
	◆	71.58"	71.58"	71.58"	35.58"	40.08"	39.58"	118.58"	142.58"	94.58"	118.58"
D 2 Light AR70 with 2 Alternate Fluor. Cells	●	4.30"	4.30"	4.30"	4.30"	4.30"	4.30"	4.30"	4.30"	4.30"	4.30"
	■	59.78"	59.78"	59.78"	24.78"	25.78"	27.78"	106.78"	130.78"	82.78"	106.78"
	◆	71.58"	71.58"	71.58"	35.58"	40.08"	39.58"	118.58"	142.58"	94.58"	118.58"
E 2 Light AR70 with 2 Center Fluor. Cells	●	4.30"	4.30"	4.30"	4.30"	4.30"	4.30"	4.30"	4.30"	4.30"	4.30"
	■	59.78"	59.78"	59.78"	24.78"	25.78"	27.78"	106.78"	130.78"	82.78"	106.78"
	◆	71.58"	71.58"	71.58"	35.58"	40.08"	39.58"	118.58"	142.58"	94.58"	118.58"
F 2 Light AR70 with 1 Center Fluor. Cell	●	4.30"	4.30"	4.30"	4.30"	4.30"	4.30"	4.30"	4.30"	4.30"	4.30"
	■	34.19"	34.19"	34.19"	16.69"	17.19"	18.19"	57.69"	69.69"	45.69"	57.69"
	◆	45.99"	45.99"	45.99"	24.49"	28.99"	35.29"	69.49"	81.49"	57.49"	69.49"
G 2 Light AR70 with 1 Fluor. Cell	●	4.30"	4.30"	4.30"	4.30"	4.30"	4.30"	4.30"	4.30"	4.30"	4.30"
	■	34.19"	34.19"	34.19"	16.69"	17.19"	18.19"	57.69"	69.69"	45.69"	57.69"
	◆	45.99"	45.99"	45.99"	24.49"	28.99"	35.29"	69.49"	81.49"	57.49"	69.49"
H 2 Light AR70 with 2 Fluor. Cells	●	4.30"	4.30"	4.30"	4.30"	4.30"	4.30"	4.30"	4.30"	4.30"	4.30"
	■	59.78"	59.78"	59.78"	24.78"	25.78"	27.78"	106.78"	130.78"	82.78"	106.78"
	◆	71.58"	71.58"	71.58"	35.58"	40.08"	39.58"	118.58"	142.58"	94.58"	118.58"
I 1 Light AR70 with 1 Fluor. Cell	●	4.30"	4.30"	4.30"	4.30"	4.30"	4.30"	4.30"	4.30"	4.30"	4.30"
	■	29.89"	29.89"	29.89"	12.39"	12.89"	13.89"	53.39"	65.39"	41.39"	53.39"
	◆	39.69"	39.69"	39.69"	22.19"	22.69"	23.69"	63.19"	75.19"	51.19"	63.19"
J 1 Light AR70 with 2 Fluor. Cells	●	4.30"	4.30"	4.30"	4.30"	4.30"	4.30"	4.30"	4.30"	4.30"	4.30"
	■	55.49"	55.49"	55.49"	20.49"	21.49"	23.49"	102.49"	126.49"	78.49"	102.49"
	◆	67.29"	67.29"	67.29"	32.29"	33.29"	29.99"	114.29"	138.29"	90.29"	114.29"
K 4 Light AR70 Double Wide with 2 Fluor. Cells	●	8.59"	8.59"	8.59"	8.59"	8.59"	8.59"	8.59"	8.59"	8.59"	8.59"
	■	34.19"	34.19"	34.19"	16.69"	17.19"	18.19"	57.69"	69.69"	45.69"	57.69"
	◆	45.99"	45.99"	45.99"	24.49"	28.99"	35.29"	69.49"	81.49"	57.49"	69.49"
L 2 Light AR70 Double Wide with 2 Fluor. Cells	●	8.59"	8.59"	8.59"	8.59"	8.59"	8.59"	8.59"	8.59"	8.59"	8.59"
	■	29.89"	29.89"	29.89"	12.39"	12.89"	13.89"	53.39"	65.39"	41.39"	53.39"
	◆	39.69"	39.69"	39.69"	22.19"	22.69"	23.69"	63.19"	75.19"	51.19"	63.19"

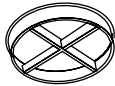
Optional Accessories - See page 216 for details.

For fluorescent accessories see page 172.

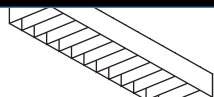
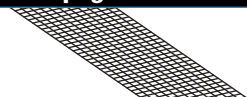
					
Baffle	Snoots	Louvers	Lenses	Parabolic Louvers	Diffusers



CR211150 A T5H039 BK WH 120 (Shown with parabolic louver)

COMBO CLASSIC RECESSED LOW VOLTAGE AR111

- Standard new construction fixture with 3/4" trim or trimless
- Combines the use of Low Voltage AR111 lamps with a choice of fluorescent lamp sources in many fixture configuration styles.

FIXTURE CONFIGURATIONS

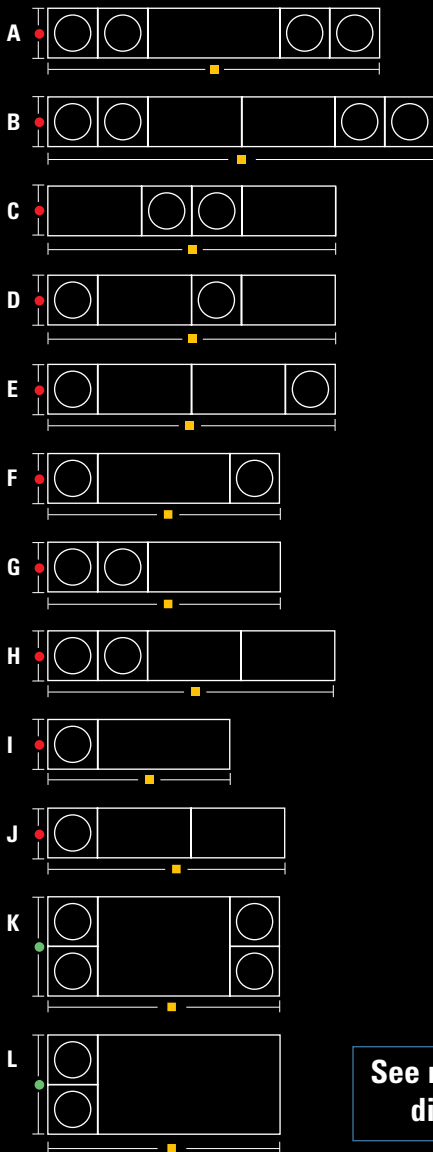

See next page for
dimensions

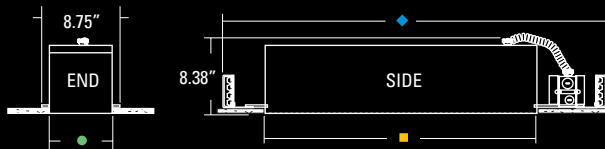

ORDERING

Item #	Description
CR211135	Combo Classic Recessed AR111 12 volt 35 watts
CR211150	Combo Classic Recessed AR111 12 volt 50 watts
CR211175	Combo Classic Recessed AR111 12 volt 75 watts
CR2111100	Combo Classic Recessed AR111 12 volt 100 watts

Item #	Description
A	4 Light AR111 with 1 Center Fluor. Cell
B	4 Light AR111 with 2 Center Fluor. Cells
C	2 Light AR111 with 2 Outer Fluor. Cells
D	2 Light AR111 with 2 Alternate Fluor. Cells
E	2 Light AR111 with 2 Center Fluor. Cells
F	2 Light AR111 with 1 Center Fluor. Cell
G	2 Light AR111 with 1 Fluor. Cell
H	2 Light AR111 with 2 Fluor. Cells
I	1 Light AR111 with 1 Fluor. Cell
J	1 Light AR111 with 2 Fluor. Cells
K	4 Lt. AR111 Double Wide with 2 Fluor. Cells
L	2 Lt. AR111 Double Wide with 2 Fluor. Cells

Item #	Description	Item #	Description
BX40	40 watt BIAX®	T528	28 watt T5
BX50	50 watt BIAX®	T535	35 watt T5
PLL80	80 watt PL-L	T5H039	39 watt T5HO
PLT26	26 watt PL-T	T5H054	54 watt T5HO
PLT32	32 watt PL-T		
PLT42	42 watt PL-T		

Item #	Description
BK	Black
WH	White
S	Industrial Silver
PT	Custom (Specify)

Item #	Description
BK	Black
WH	White
S	Industrial Silver
PT	Custom (Specify)
TR	Trimless (NO TRIM)

Item #	Description
120	120 Volts
277	277 Volts

Ordering Example

FIXTURE TYPE	FIXTURE CONFIGURATION	FLUORESCENT CELL	INTERIOR	TRIM	VOLTS
CR21150	A	T5H039	BK	WH	120

Combo Classic Recessed Mount, Four light 50 Watt AR111 with One 39 Watt T5HO Cell, Black Interior, White Trim, 120 volts

- Standard new construction fixture offered with 3/4" trim or as a trimless fixture
- Plaster frame can accommodate 1/2" to 1" ceiling thickness
- Includes butterfly brackets for commercial installations
- Low voltage electronic transformer with fuse and short circuit protection



- Fluorescent cells available with a wide array of accessories such as high transmission overlays and parabolic louvers (see page 172)
- Custom configurations are available (Consult RSA Customer Service)
- Also available in Surface Mounted Models (see page 150 - 171)

COMBO CLASSIC AR111 RECESSED FIXTURE CONFIGURATION DIMENSIONS

AR111 Fixture Configuration		BX40	BX50	PLL80	PLT26	PLT32	PLT42	T528	T535	T5HO39	T5HO54
A 4 Light AR111 with 1 Center Fluor. Cell	●	7.00"	7.00"	7.00"	7.00"	7.00"	7.00"	7.00"	7.00"	7.00"	7.00"
	■	53.58"	54.58"	55.58"	36.08"	36.58"	37.58"	77.08"	89.08"	65.08"	77.08"
	◆	65.38"	65.38"	65.38"	47.88"	48.38"	49.38"	88.88"	100.88"	76.88"	88.88"
B 4 Light AR111 with 2 Center Fluor. Cells	●	7.00"	7.00"	7.00"	7.00"	7.00"	7.00"	7.00"	7.00"	7.00"	7.00"
	■	79.18"	79.18"	79.18"	44.18"	45.18"	47.18"	126.18"	150.18"	102.18"	126.18"
	◆	90.98"	90.98"	90.98"	55.98"	56.98"	58.98"	139.98"	161.98"	113.98"	137.98"
C 2 Light AR111 with 2 Outer Fluor. Cells	●	7.00"	7.00"	7.00"	7.00"	7.00"	7.00"	7.00"	7.00"	7.00"	7.00"
	■	65.18"	65.18"	65.18"	30.18"	31.18"	33.18"	112.18"	136.18"	88.18"	112.18"
	◆	76.98"	76.98"	76.98"	41.98"	42.98"	44.98"	123.98"	147.98"	99.98"	123.98"
D 2 Light AR111 with 2 Alternate Fluor. Cells	●	7.00"	7.00"	7.00"	7.00"	7.00"	7.00"	7.00"	7.00"	7.00"	7.00"
	■	65.18"	65.18"	65.18"	30.18"	31.18"	33.18"	112.18"	136.18"	88.18"	112.18"
	◆	76.98"	76.98"	76.98"	41.98"	42.98"	44.98"	123.98"	147.98"	99.98"	123.98"
E 2 Light AR111 with 2 Center Fluor. Cells	●	7.00"	7.00"	7.00"	7.00"	7.00"	7.00"	7.00"	7.00"	7.00"	7.00"
	■	65.18"	65.18"	65.18"	30.18"	31.18"	33.18"	112.18"	136.18"	88.18"	112.18"
	◆	76.98"	76.98"	76.98"	41.98"	42.98"	44.98"	123.98"	147.98"	99.98"	123.98"
F 2 Light AR111 with 1 Center Fluor. Cell	●	7.00"	7.00"	7.00"	7.00"	7.00"	7.00"	7.00"	7.00"	7.00"	7.00"
	■	39.59"	39.59"	39.59"	22.09"	22.59"	23.59"	63.09"	75.09"	51.09"	63.09"
	◆	51.39"	51.39"	51.39"	33.89"	34.89"	35.89"	74.89"	86.89"	62.89"	74.89"
G 2 Light AR111 with 1 Fluor. Cell	●	7.00"	7.00"	7.00"	7.00"	7.00"	7.00"	7.00"	7.00"	7.00"	7.00"
	■	39.59"	39.59"	39.59"	22.09"	22.59"	23.59"	63.09"	75.09"	51.09"	63.09"
	◆	51.39"	51.39"	51.39"	33.89"	34.89"	35.89"	74.89"	86.89"	62.89"	74.89"
H 2 Light AR111 with 2 Fluor. Cells	●	7.00"	7.00"	7.00"	7.00"	7.00"	7.00"	7.00"	7.00"	7.00"	7.00"
	■	65.18"	65.18"	65.18"	30.18"	31.18"	33.18"	112.18"	136.18"	88.18"	112.18"
	◆	76.98"	76.98"	76.98"	41.98"	42.98"	44.98"	123.98"	147.98"	99.98"	123.98"
I 1 Light AR111 with 1 Fluor. Cell	●	7.00"	7.00"	7.00"	7.00"	7.00"	7.00"	7.00"	7.00"	7.00"	7.00"
	■	32.59"	32.59"	32.59"	15.09"	15.59"	16.59"	56.09"	68.09"	44.09"	56.09"
	◆	42.39"	42.39"	42.39"	24.89"	25.39"	26.39"	65.89"	77.89"	53.89"	65.89"
J 1 Light AR111 with 2 Fluor. Cells	●	7.00"	7.00"	7.00"	7.00"	7.00"	7.00"	7.00"	7.00"	7.00"	7.00"
	■	58.19"	58.19"	58.19"	23.19"	24.19"	26.19"	105.19"	129.19"	81.19"	105.19"
	◆	69.99"	69.99"	69.99"	34.99"	35.99"	37.99"	116.99"	140.99"	92.99"	116.99"
K 4 Light AR111 Double Wide with 2 Fluor. Cells	●	13.99"	13.99"	13.99"	13.99"	13.99"	13.99"	13.99"	13.99"	13.99"	13.99"
	■	39.59"	39.59"	39.59"	22.09"	22.59"	23.59"	63.09"	75.09"	51.09"	63.09"
	◆	51.39"	51.39"	51.39"	33.89"	34.89"	35.89"	74.89"	86.89"	62.89"	74.89"
L 2 Light AR111 Double Wide with 2 Fluor. Cells	●	13.99"	13.99"	13.99"	13.99"	13.99"	13.99"	13.99"	13.99"	13.99"	13.99"
	■	32.59"	32.59"	32.59"	15.09"	15.59"	16.59"	56.09"	68.09"	44.09"	56.09"
	◆	42.39"	42.39"	42.39"	24.89"	25.39"	26.39"	65.89"	77.89"	53.89"	65.89"

Optional Accessories - See page 216 for details.

For fluorescent accessories see page 172.

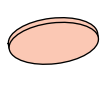
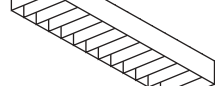
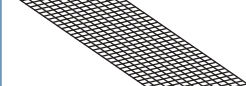
					
Baffle	Snoots	Louvers	Lenses	Parabolic Louvers	Diffusers

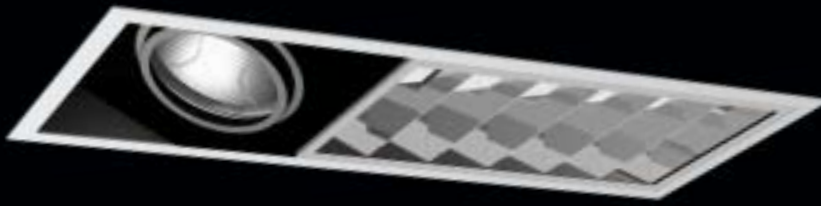

CR220 | PLT32 BK WH (Shown with parabolic louver)

COMBO CLASSIC RECESSED LINE VOLTAGE PAR20

- Standard new construction fixture with 3/4" trim or trimless
- Combines the use of Line Voltage PAR20 lamps with a choice of fluorescent lamp sources in many fixture configuration styles.

FIXTURE CONFIGURATIONS

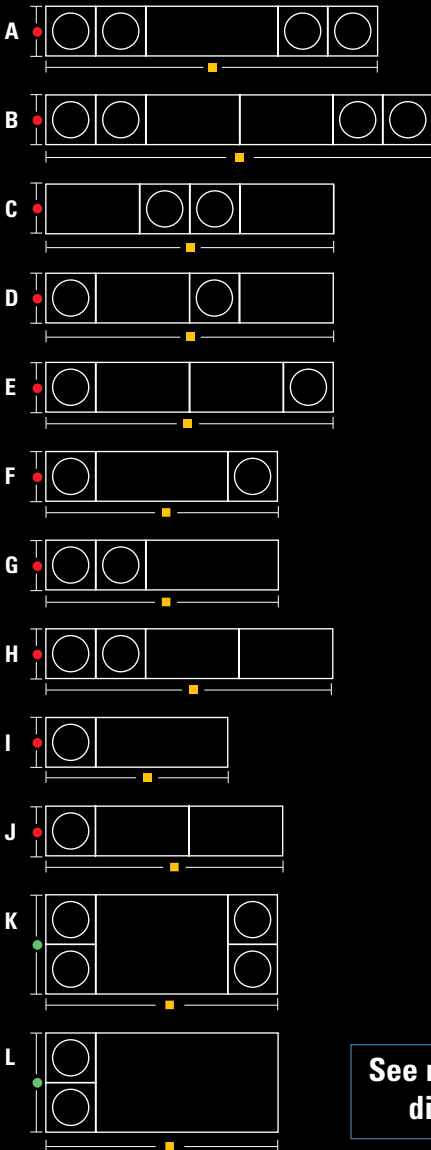

See next page for
dimensions

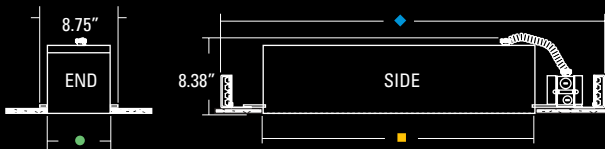

ORDERING

Item #	Description
CR220	Combo Classic Recessed PAR20 120 volt

Item #	Description
A	4 Light PAR20 with 1 Center Fluor. Cell
B	4 Light PAR20 with 2 Center Fluor. Cells
C	2 Light PAR20 with 2 Outer Fluor. Cells
D	2 Light PAR20 with 2 Alternate Fluor. Cells
E	2 Light PAR20 with 2 Center Fluor. Cells
F	2 Light PAR20 with 1 Center Fluor. Cell
G	2 Light PAR20 with 1 Fluor. Cell
H	2 Light PAR20 with 2 Fluor. Cells
I	1 Light PAR20 with 1 Fluor. Cell
J	1 Light PAR20 with 2 Fluor. Cells
K	4 Light PAR20 Double Wide with 2 Fluor. Cells
L	2 Light PAR20 Double Wide with 2 Fluor. Cells

Item #	Description
BX40	40 watt BIAX®
BX50	50 watt BIAX®
PLL80	80 watt PL-L
PLT26	26 watt PL-T
PLT32	32 watt PL-T
PLT42	42 watt PL-T
T528	28 watt T5
T535	35 watt T5
T5H039	39 watt T5HO
T5H054	54 watt T5HO

Item #	Description
BK	Black
WH	White
S	Industrial Silver
PT	Custom (Specify)

Item #	Description
BK	Black
WH	White
S	Industrial Silver
PT	Custom (Specify)
TR	Trimless (NO TRIM)

Ordering Example

FIXTURE TYPE	FIXTURE CONFIGURATION	FLUORESCENT CELL	INTERIOR	TRIM
CR220	I	PLT32	BK	WH

Combo Classic Recessed Mount, One light 120V PAR20 with One 32 Watt PLT Cell, Black Interior, White Trim

- Standard new construction fixture offered with 3/4" trim or as a trimless fixture
- Plaster frame can accommodate 1/2" to 1" ceiling thickness
- Includes butterfly brackets for commercial installations



- Fluorescent cells available with a wide array of accessories such as high transmission overlays and parabolic louvers (see page 172)
- Custom configurations are available (Consult RSA Customer Service)
- Also available in Surface Mounted Models (see page 150 - 171)

COMBO CLASSIC PAR20 RECESSED FIXTURE CONFIGURATION DIMENSIONS

PAR20 Fixture Configuration		BX40	BX50	PLL80	PLT26	PLT32	PLT42	T528	T535	T5HO39	T5HO54
A 4 Light PAR20 with 1 Center Fluor. Cell	●	7.00"	7.00"	7.00"	7.00"	7.00"	7.00"	7.00"	7.00"	7.00"	7.00"
	■	53.58"	54.58"	55.58"	36.08"	36.58"	37.58"	77.08"	89.08"	65.08"	77.08"
	◆	65.38"	65.38"	65.38"	47.88"	48.38"	49.38"	88.88"	100.88"	76.88"	88.88"
B 4 Light PAR20 with 2 Center Fluor. Cells	●	7.00"	7.00"	7.00"	7.00"	7.00"	7.00"	7.00"	7.00"	7.00"	7.00"
	■	79.18"	79.18"	79.18"	44.18"	45.18"	47.18"	126.18"	150.18"	102.18"	126.18"
	◆	90.98"	90.98"	90.98"	55.98"	56.98"	58.98"	139.98"	161.98"	113.98"	137.98"
C 2 Light PAR20 with 2 Outer Fluor. Cells	●	7.00"	7.00"	7.00"	7.00"	7.00"	7.00"	7.00"	7.00"	7.00"	7.00"
	■	65.18"	65.18"	65.18"	30.18"	31.18"	33.18"	112.18"	136.18"	88.18"	112.18"
	◆	76.98"	76.98"	76.98"	41.98"	42.98"	44.98"	123.98"	147.98"	99.98"	123.98"
D 2 Light PAR20 with 2 Alternate Fluor. Cells	●	7.00"	7.00"	7.00"	7.00"	7.00"	7.00"	7.00"	7.00"	7.00"	7.00"
	■	65.18"	65.18"	65.18"	30.18"	31.18"	33.18"	112.18"	136.18"	88.18"	112.18"
	◆	76.98"	76.98"	76.98"	41.98"	42.98"	44.98"	123.98"	147.98"	99.98"	123.98"
E 2 Light PAR20 with 2 Center Fluor. Cells	●	7.00"	7.00"	7.00"	7.00"	7.00"	7.00"	7.00"	7.00"	7.00"	7.00"
	■	65.18"	65.18"	65.18"	30.18"	31.18"	33.18"	112.18"	136.18"	88.18"	112.18"
	◆	76.98"	76.98"	76.98"	41.98"	42.98"	44.98"	123.98"	147.98"	99.98"	123.98"
F 2 Light PAR20 with 1 Center Fluor. Cell	●	7.00"	7.00"	7.00"	7.00"	7.00"	7.00"	7.00"	7.00"	7.00"	7.00"
	■	39.59"	39.59"	39.59"	22.09"	22.59"	23.59"	63.09"	75.09"	51.09"	63.09"
	◆	51.39"	51.39"	51.39"	33.89"	34.89"	35.89"	74.89"	86.89"	62.89"	74.89"
G 2 Light PAR20 with 1 Fluor. Cell	●	7.00"	7.00"	7.00"	7.00"	7.00"	7.00"	7.00"	7.00"	7.00"	7.00"
	■	39.59"	39.59"	39.59"	22.09"	22.59"	23.59"	63.09"	75.09"	51.09"	63.09"
	◆	51.39"	51.39"	51.39"	33.89"	34.89"	35.89"	74.89"	86.89"	62.89"	74.89"
H 2 Light PAR20 with 2 Fluor. Cells	●	7.00"	7.00"	7.00"	7.00"	7.00"	7.00"	7.00"	7.00"	7.00"	7.00"
	■	65.18"	65.18"	65.18"	30.18"	31.18"	33.18"	112.18"	136.18"	88.18"	112.18"
	◆	76.98"	76.98"	76.98"	41.98"	42.98"	44.98"	123.98"	147.98"	99.98"	123.98"
I 1 Light PAR20 with 1 Fluor. Cell	●	7.00"	7.00"	7.00"	7.00"	7.00"	7.00"	7.00"	7.00"	7.00"	7.00"
	■	32.59"	32.59"	32.59"	15.09"	15.59"	16.59"	56.09"	68.09"	44.09"	56.09"
	◆	42.39"	42.39"	42.39"	24.89"	25.39"	26.39"	65.89"	77.89"	53.89"	65.89"
J 1 Light PAR20 with 2 Fluor. Cells	●	7.00"	7.00"	7.00"	7.00"	7.00"	7.00"	7.00"	7.00"	7.00"	7.00"
	■	58.19"	58.19"	58.19"	23.19"	24.19"	26.19"	105.19"	129.19"	81.19"	105.19"
	◆	69.99"	69.99"	69.99"	34.99"	35.99"	37.99"	116.99"	140.99"	92.99"	116.99"
K 4 Light PAR20 Double Wide with 2 Fluor. Cells	●	13.99"	13.99"	13.99"	13.99"	13.99"	13.99"	13.99"	13.99"	13.99"	13.99"
	■	39.59"	39.59"	39.59"	22.09"	22.59"	23.59"	63.09"	75.09"	51.09"	63.09"
	◆	51.39"	51.39"	51.39"	33.89"	34.89"	35.89"	74.89"	86.89"	62.89"	74.89"
L 2 Light PAR20 Double Wide with 2 Fluor. Cells	●	13.99"	13.99"	13.99"	13.99"	13.99"	13.99"	13.99"	13.99"	13.99"	13.99"
	■	32.59"	32.59"	32.59"	15.09"	15.59"	16.59"	56.09"	68.09"	44.09"	56.09"
	◆	42.39"	42.39"	42.39"	24.89"	25.39"	26.39"	65.89"	77.89"	53.89"	65.89"

Optional Accessories - See page 216 for details.

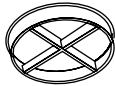
For fluorescent accessories see page 172.

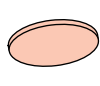
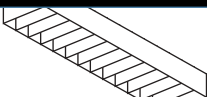
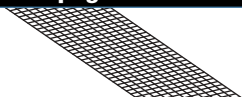
					
Baffle	Snoots	Louvers	Lenses	Parabolic Louvers	Diffusers



CR230 G T5H039 WH WH (Shown with prismatic diffuser and cross baffle accessories)

COMBO CLASSIC RECESSED LINE VOLTAGE PAR30

- Standard new construction fixture with 3/4" trim or trimless
- Combines the use of Line Voltage PAR30 lamps with a choice of fluorescent lamp sources in many fixture configuration styles.

FIXTURE CONFIGURATIONS

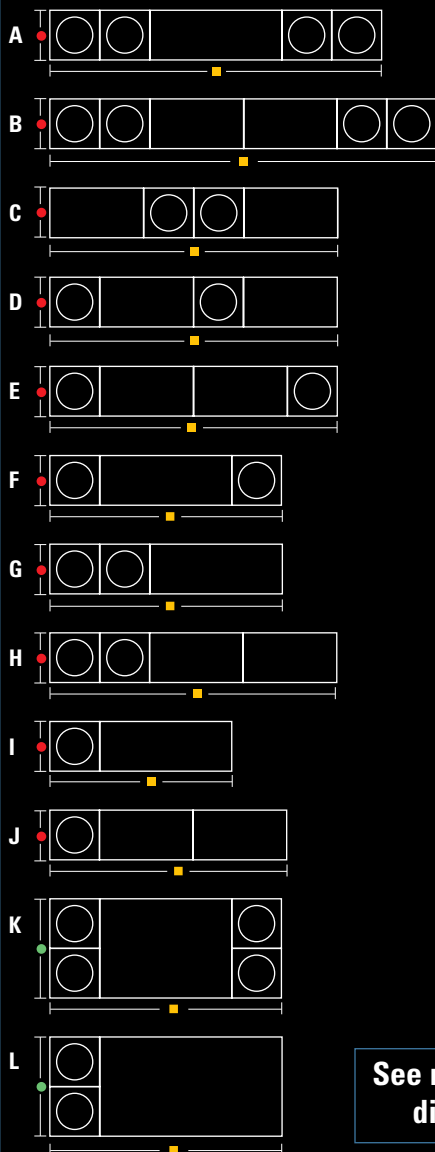

See next page for
dimensions

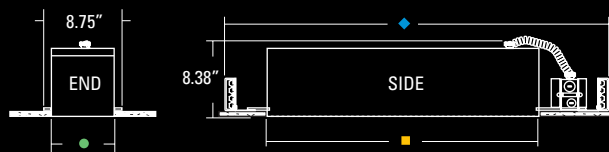

ORDERING

Item #	Description
CR230	Combo Classic Recessed PAR30 120 volt

Item #	Description
A	4 Light PAR30 with 1 Center Fluor. Cell
B	4 Light PAR30 with 2 Center Fluor. Cells
C	2 Light PAR30 with 2 Outer Fluor. Cells
D	2 Light PAR30 with 2 Alternate Fluor. Cells
E	2 Light PAR30 with 2 Center Fluor. Cells
F	2 Light PAR30 with 1 Center Fluor. Cell
G	2 Light PAR30 with 1 Fluor. Cell
H	2 Light PAR30 with 2 Fluor. Cells
I	1 Light PAR30 with 1 Fluor. Cell
J	1 Light PAR30 with 2 Fluor. Cells
K	4 Light PAR30 Double Wide with 2 Fluor. Cells
L	2 Light PAR30 Double Wide with 2 Fluor. Cells

Item #	Description
BX40	40 watt BIAX®
BX50	50 watt BIAX®
PLL80	80 watt PL-L
PLT26	26 watt PL-T
PLT32	32 watt PL-T
PLT42	42 watt PL-T
T528	28 watt T5
T535	35 watt T5
T5H039	39 watt T5HO
T5H054	54 watt T5HO

Item #	Description
BK	Black
WH	White
S	Industrial Silver
PT	Custom (Specify)

Item #	Description
BK	Black
WH	White
S	Industrial Silver
PT	Custom (Specify)
TR	Trimless (NO TRIM)

Ordering Example

FIXTURE TYPE	FIXTURE CONFIGURATION	FLUORESCENT CELL	INTERIOR	TRIM
CR230	G	T5H039	WH	WH

Combo Classic Recessed Mount, Two light 120V PAR30 with One 39 Watt T5HO Cell, White Interior, White Trim





- Standard new construction fixture offered with 3/4" trim or as a trimless fixture
- Plaster frame can accommodate 1/2" to 1" ceiling thickness
- Includes butterfly brackets for commercial installations
- Fluorescent cells available with a wide array of accessories such as high transmission overlays and parabolic louvers (see page 172)
- Custom configurations are available (Consult RSA Customer Service)
- Also available in Surface Mounted Models (see page 150 - 171)

COMBO CLASSIC PAR30 RECESSED FIXTURE CONFIGURATION DIMENSIONS

PAR30 Fixture Configuration		BX40	BX50	PLL80	PLT26	PLT32	PLT42	T528	T535	T5HO39	T5HO54
A 4 Light PAR30 with 1 Center Fluor. Cell	●	7.00"	7.00"	7.00"	7.00"	7.00"	7.00"	7.00"	7.00"	7.00"	7.00"
	■	53.58"	54.58"	55.58"	36.08"	36.58"	37.58"	77.08"	89.08"	65.08"	77.08"
	◆	65.38"	65.38"	65.38"	47.88"	48.38"	49.38"	88.88"	100.88"	76.88"	88.88"
B 4 Light PAR30 with 2 Center Fluor. Cells	●	7.00"	7.00"	7.00"	7.00"	7.00"	7.00"	7.00"	7.00"	7.00"	7.00"
	■	79.18"	79.18"	79.18"	44.18"	45.18"	47.18"	126.18"	150.18"	102.18"	126.18"
	◆	90.98"	90.98"	90.98"	55.98"	56.98"	58.98"	139.98"	161.98"	113.98"	137.98"
C 2 Light PAR30 with 2 Outer Fluor. Cells	●	7.00"	7.00"	7.00"	7.00"	7.00"	7.00"	7.00"	7.00"	7.00"	7.00"
	■	65.18"	65.18"	65.18"	30.18"	31.18"	33.18"	112.18"	136.18"	88.18"	112.18"
	◆	76.98"	76.98"	76.98"	41.98"	42.98"	44.98"	123.98"	147.98"	99.98"	123.98"
D 2 Light PAR30 with 2 Alternate Fluor. Cells	●	7.00"	7.00"	7.00"	7.00"	7.00"	7.00"	7.00"	7.00"	7.00"	7.00"
	■	65.18"	65.18"	65.18"	30.18"	31.18"	33.18"	112.18"	136.18"	88.18"	112.18"
	◆	76.98"	76.98"	76.98"	41.98"	42.98"	44.98"	123.98"	147.98"	99.98"	123.98"
E 2 Light PAR30 with 2 Center Fluor. Cells	●	7.00"	7.00"	7.00"	7.00"	7.00"	7.00"	7.00"	7.00"	7.00"	7.00"
	■	65.18"	65.18"	65.18"	30.18"	31.18"	33.18"	112.18"	136.18"	88.18"	112.18"
	◆	76.98"	76.98"	76.98"	41.98"	42.98"	44.98"	123.98"	147.98"	99.98"	123.98"
F 2 Light PAR30 with 1 Center Fluor. Cell	●	7.00"	7.00"	7.00"	7.00"	7.00"	7.00"	7.00"	7.00"	7.00"	7.00"
	■	39.59"	39.59"	39.59"	22.09"	22.59"	23.59"	63.09"	75.09"	51.09"	63.09"
	◆	51.39"	51.39"	51.39"	33.89"	34.89"	35.89"	74.89"	86.89"	62.89"	74.89"
G 2 Light PAR30 with 1 Fluor. Cell	●	7.00"	7.00"	7.00"	7.00"	7.00"	7.00"	7.00"	7.00"	7.00"	7.00"
	■	39.59"	39.59"	39.59"	22.09"	22.59"	23.59"	63.09"	75.09"	51.09"	63.09"
	◆	51.39"	51.39"	51.39"	33.89"	34.89"	35.89"	74.89"	86.89"	62.89"	74.89"
H 2 Light PAR30 with 2 Fluor. Cells	●	7.00"	7.00"	7.00"	7.00"	7.00"	7.00"	7.00"	7.00"	7.00"	7.00"
	■	65.18"	65.18"	65.18"	30.18"	31.18"	33.18"	112.18"	136.18"	88.18"	112.18"
	◆	76.98"	76.98"	76.98"	41.98"	42.98"	44.98"	123.98"	147.98"	99.98"	123.98"
I 1 Light PAR30 with 1 Fluor. Cell	●	7.00"	7.00"	7.00"	7.00"	7.00"	7.00"	7.00"	7.00"	7.00"	7.00"
	■	32.59"	32.59"	32.59"	15.09"	15.59"	16.59"	56.09"	68.09"	44.09"	56.09"
	◆	42.39"	42.39"	42.39"	24.89"	25.39"	26.39"	65.89"	77.89"	53.89"	65.89"
J 1 Light PAR30 with 2 Fluor. Cells	●	7.00"	7.00"	7.00"	7.00"	7.00"	7.00"	7.00"	7.00"	7.00"	7.00"
	■	58.19"	58.19"	58.19"	23.19"	24.19"	26.19"	105.19"	129.19"	81.19"	105.19"
	◆	69.99"	69.99"	69.99"	34.99"	35.99"	37.99"	116.99"	140.99"	92.99"	116.99"
K 4 Light PAR30 Double Wide with 2 Fluor. Cells	●	13.99"	13.99"	13.99"	13.99"	13.99"	13.99"	13.99"	13.99"	13.99"	13.99"
	■	39.59"	39.59"	39.59"	22.09"	22.59"	23.59"	63.09"	75.09"	51.09"	63.09"
	◆	51.39"	51.39"	51.39"	33.89"	34.89"	35.89"	74.89"	86.89"	62.89"	74.89"
L 2 Light PAR30 Double Wide with 2 Fluor. Cells	●	13.99"	13.99"	13.99"	13.99"	13.99"	13.99"	13.99"	13.99"	13.99"	13.99"
	■	32.59"	32.59"	32.59"	15.09"	15.59"	16.59"	56.09"	68.09"	44.09"	56.09"
	◆	42.39"	42.39"	42.39"	24.89"	25.39"	26.39"	65.89"	77.89"	53.89"	65.89"

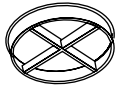
Optional Accessories - See page 216 for details.

For fluorescent accessories see page 172.

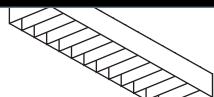
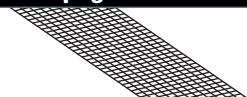
					
Baffle	Snoots	Louvers	Lenses	Parabolic Louvers	Diffusers



CR338 L BX40 BK WH (Shown with parabolic louver)

COMBO CLASSIC RECESSED LINE VOLTAGE PAR38

- Standard new construction fixture with 3/4" trim or trimless
- Combines the use of Line Voltage PAR38 lamps with a choice of fluorescent lamp sources in many fixture configuration styles.

FIXTURE CONFIGURATIONS

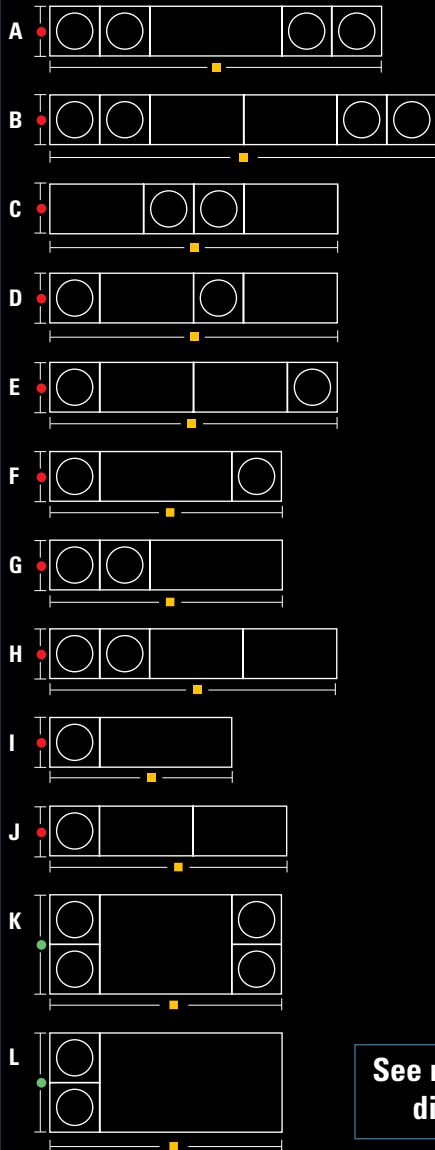

See next page for
dimensions

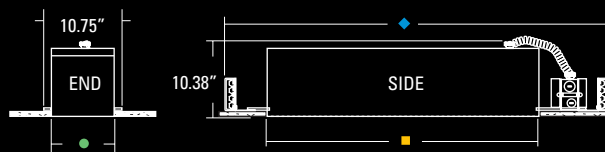

ORDERING

Item #	Description
CR338	Combo Classic Recessed PAR38 120 volt

Item #	Description
A	4 Light PAR38 with 1 Center Fluor. Cell
B	4 Light PAR38 with 2 Center Fluor. Cells
C	2 Light PAR38 with 2 Outer Fluor. Cells
D	2 Light PAR38 with 2 Alternate Fluor. Cells
E	2 Light PAR38 with 2 Center Fluor. Cells
F	2 Light PAR38 with 1 Center Fluor. Cell
G	2 Light PAR38 with 1 Fluor. Cell
H	2 Light PAR38 with 2 Fluor. Cells
I	1 Light PAR38 with 1 Fluor. Cell
J	1 Light PAR38 with 2 Fluor. Cells
K	4 Light PAR38 Double Wide with 2 Fluor. Cells
L	2 Light PAR38 Double Wide with 2 Fluor. Cells

Item #	Description
BX40	40 watt BIAX®
BX50	50 watt BIAX®
PLL80	80 watt PL-L
PLT26	26 watt PL-T
PLT32	32 watt PL-T
PLT42	42 watt PL-T
T528	28 watt T5
T535	35 watt T5
T5H039	39 watt T5HO
T5H054	54 watt T5HO

Item #	Description
BK	Black
WH	White
S	Industrial Silver
PT	Custom (Specify)

Item #	Description
BK	Black
WH	White
S	Industrial Silver
PT	Custom (Specify)
TR	Trimless (NO TRIM)

Ordering Example

FIXTURE TYPE	FIXTURE CONFIGURATION	FLUORESCENT CELL	INTERIOR	TRIM
CR338	L	BX40	BK	WH

Combo Classic Recessed Mount, Two light 120V PAR38 with Two 40 Watt BIAX Double Wide Cell, Black Interior, White Trim

- Standard new construction fixture offered with 3/4" trim or as a trimless fixture
- Plaster frame can accommodate 1/2" to 1" ceiling thickness
- Includes butterfly brackets for commercial installations

- Fluorescent cells available with a wide array of accessories such as high transmission overlays and parabolic louvers (see page 172)

- Custom configurations are available (Consult RSA Customer Service)





- Also available in Surface Mounted Models (see page 150 - 171)

COMBO CLASSIC PAR38 RECESSED FIXTURE CONFIGURATION DIMENSIONS

PAR38 Fixture Configuration		BX40	BX50	PLL80	PLT26	PLT32	PLT42	T528	T535	T5HO39	T5HO54
A 4 Light PAR38 with 1 Center Fluor. Cell	●	8.90"	8.90"	8.90"	8.90"	8.90"	8.90"	8.90"	8.90"	8.90"	8.90"
	■	61.68"	61.68"	61.68"	43.68"	44.18"	45.18"	84.68"	96.68"	72.68"	84.68"
	◆	77.98"	77.98"	77.98"	60.48"	60.98"	61.98"	101.48"	113.48"	89.48"	101.48"
B 4 Light PAR38 with 2 Center Fluor. Cells	●	8.90"	8.90"	8.90"	8.90"	8.90"	8.90"	8.90"	8.90"	8.90"	8.90"
	■	86.78"	86.78"	86.78"	51.78"	52.78"	54.78"	133.78"	157.78"	109.78"	133.78"
	◆	103.58"	103.58"	103.58"	68.58"	69.58"	71.58"	150.58"	174.58"	126.58"	150.58"
C 2 Light PAR38 with 2 Outer Fluor. Cells	●	8.90"	8.90"	8.90"	8.90"	8.90"	8.90"	8.90"	8.90"	8.90"	8.90"
	■	68.98"	68.98"	68.98"	33.98"	34.98"	36.98"	115.98"	139.98"	91.98"	115.98"
	◆	85.78"	85.78"	85.78"	50.78"	51.78"	53.78"	132.78"	156.78"	108.78"	132.78"
D 2 Light PAR38 with 2 Alternate Fluor. Cells	●	8.90"	8.90"	8.90"	8.90"	8.90"	8.90"	8.90"	8.90"	8.90"	8.90"
	■	68.98"	68.98"	68.98"	33.98"	34.98"	36.98"	115.98"	139.98"	91.98"	115.98"
	◆	85.78"	85.78"	85.78"	50.78"	51.78"	53.78"	132.78"	156.78"	108.78"	132.78"
E 2 Light PAR38 with 2 Center Fluor. Cells	●	8.90"	8.90"	8.90"	8.90"	8.90"	8.90"	8.90"	8.90"	8.90"	8.90"
	■	68.98"	68.98"	68.98"	33.98"	34.98"	36.98"	115.98"	139.98"	91.98"	115.98"
	◆	85.78"	85.78"	85.78"	50.78"	51.78"	53.78"	132.78"	156.78"	108.78"	132.78"
F 2 Light PAR38 with 1 Center Fluor. Cell	●	8.90"	8.90"	8.90"	8.90"	8.90"	8.90"	8.90"	8.90"	8.90"	8.90"
	■	43.39"	43.39"	43.39"	25.89"	26.39"	27.39"	66.89"	78.89"	54.89"	66.89"
	◆	60.19"	60.19"	60.19"	42.69"	43.19"	44.19"	83.69"	95.69"	71.69"	83.69"
G 2 Light PAR38 with 1 Fluor. Cell	●	8.90"	8.90"	8.90"	8.90"	8.90"	8.90"	8.90"	8.90"	8.90"	8.90"
	■	43.39"	43.39"	43.39"	25.89"	26.39"	27.39"	66.89"	78.89"	54.89"	66.89"
	◆	60.19"	60.19"	60.19"	42.69"	43.19"	44.19"	83.69"	95.69"	71.69"	83.69"
H 2 Light PAR38 with 2 Fluor. Cells	●	8.90"	8.90"	8.90"	8.90"	8.90"	8.90"	8.90"	8.90"	8.90"	8.90"
	■	68.98"	68.98"	68.98"	33.98"	34.98"	36.98"	115.98"	139.98"	91.98"	115.98"
	◆	85.78"	85.78"	85.78"	50.78"	51.78"	53.78"	132.78"	156.78"	108.78"	132.78"
I 1 Light PAR38 with 1 Fluor. Cell	●	8.90"	8.90"	8.90"	8.90"	8.90"	8.90"	8.90"	8.90"	8.90"	8.90"
	■	34.49"	34.49"	34.49"	16.99"	17.49"	18.49"	57.99"	69.99"	45.99"	57.99"
	◆	46.29"	46.29"	46.29"	28.79"	29.29"	30.29"	69.79"	81.79"	57.79"	74.79"
J 1 Light PAR38 with 2 Fluor. Cells	●	8.90"	8.90"	8.90"	8.90"	8.90"	8.90"	8.90"	8.90"	8.90"	8.90"
	■	60.09"	60.09"	60.09"	25.09"	26.09"	28.09"	107.09"	131.09"	83.09"	107.09"
	◆	76.89"	76.89"	76.89"	41.89"	42.89"	44.89"	123.89"	147.89"	99.89"	123.89"
K 4 Light PAR38 Double Wide with 2 Fluor. Cells	●	17.79"	17.79"	17.79"	17.79"	17.79"	17.79"	17.79"	17.79"	17.79"	17.79"
	■	43.39"	43.39"	43.39"	25.89"	26.39"	27.39"	66.89"	78.89"	54.89"	66.89"
	◆	60.19"	60.19"	60.19"	42.69"	43.19"	44.19"	83.69"	95.69"	71.69"	83.69"
L 2 Light PAR38 Double Wide with 2 Fluor. Cells	●	17.79"	17.79"	17.79"	17.79"	17.79"	17.79"	17.79"	17.79"	17.79"	17.79"
	■	34.49"	34.49"	34.49"	16.99"	17.49"	18.49"	57.99"	69.99"	45.99"	57.99"
	◆	46.29"	46.29"	46.29"	28.79"	29.29"	30.29"	69.79"	81.79"	57.79"	74.79"

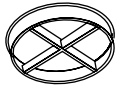
Optional Accessories - See page 216 for details.

For fluorescent accessories see page 172.

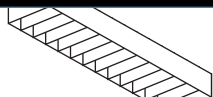
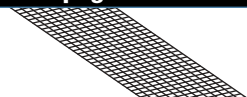
					
Baffle	Snoots	Louvers	Lenses	Parabolic Louvers	Diffusers



CR220M39 F BX40 BK S 120 (Shown with parabolic louver)

COMBO CLASSIC RECESSED PAR20MH METAL HALIDE

- Standard new construction fixture with 3/4" trim or trimless
- Combines the use of PAR20 Metal Halide lamps with a choice of fluorescent lamp sources in many fixture configuration styles.

FIXTURE CONFIGURATIONS

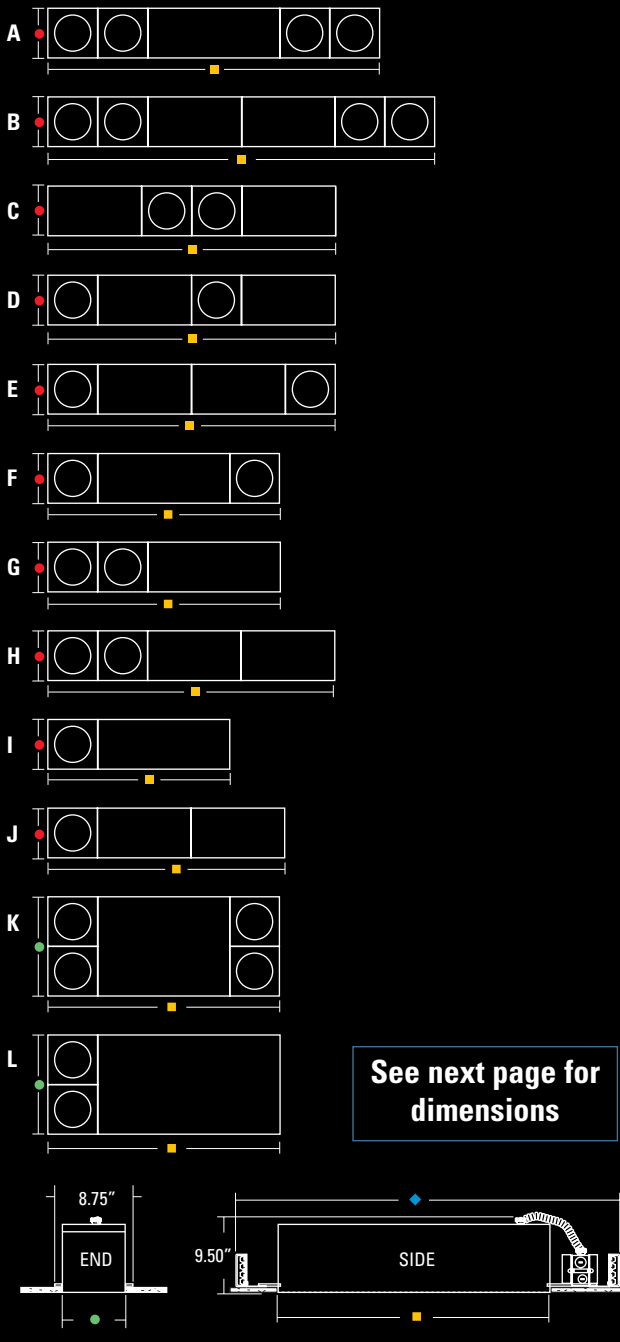

ORDERING

1	FIXTURE	Item #	Description
		CR220M39	Combo Classic Recessed PAR20MH 39 watts

2	FIXTURE CONFIGURATION	Item #	Description
		A	4 Light PAR20MH with 1 Center Fluor. Cell
B	4 Light PAR20MH with 2 Center Fluor. Cells		
C	2 Light PAR20MH with 2 Outer Fluor. Cells		
D	2 Light PAR20MH with 2 Alternate Fluor. Cells		
E	2 Light PAR20MH with 1 Center Fluor. Cell		
F	2 Light PAR20MH with 1 Fluor. Cell		
G	2 Light PAR20MH with 2 Fluor. Cells		
H	1 Light PAR20MH with 1 Fluor. Cell		
I	1 Light PAR20MH with 2 Fluor. Cells		
J	4 Lt. PAR20MH Double Wide with 2 Fluor. Cells		
K	2 Lt. PAR20MH Double Wide with 2 Fluor. Cells		

3	FLUORESCENT CELL	Item #	Description	Item #	Description
		BX40	40 watt BIAX®	T528	28 watt T5
BX50	50 watt BIAX®	T535	35 watt T5		
PLL80	80 watt PL-L	T5H039	39 watt T5HO		
PLT26	26 watt PL-T	T5H054	54 watt T5HO		
PLT32	32 watt PL-T				
PLT42	42 watt PL-T				

4	INTERIOR	Item #	Description
		BK	Black
WH	White		
S	Industrial Silver		
PT	Custom (Specify)		

5	TRIM	Item #	Description
		BK	Black
WH	White		
S	Industrial Silver		
PT	Custom (Specify)		
TR	Trimless (NO TRIM)		

6	VOLTAGE	Item #	Description
		120	120 Volts
277	277 Volts		

Ordering Example

FIXTURE TYPE	CONFIGURATION	FLUORESCENT CELL	INTERIOR	TRIM	VOLTS
CR220M39	F	BX40	BK	S	120

Combo Classic Recessed Mount, Two light 39 Watt PAR20MH with One 40 Watt BIAX, Black Interior, Industrial Silver trim, 120 volts

- Standard new construction fixture offered with 3/4" trim or as a trimless fixture
- Plaster frame can accommodate 1/2" to 1" ceiling thickness
- Includes butterfly brackets for commercial installations
- Aromat® Electronic Ballast





- Fluorescent cells available with a wide array of accessories such as high transmission overlays and parabolic louvers (see page 172)
- Custom configurations are available (Consult RSA Customer Service)
- Also available in Surface Mounted Models (see page 150 - 171)

COMBO CLASSIC PAR20MH RECESSED FIXTURE CONFIGURATION DIMENSIONS

PAR20MH Fixture Configuration		BX40	BX50	PLL80	PLT26	PLT32	PLT42	T528	T535	T5HO39	T5HO54
A 4 Light PAR20MH with 1 Center Fluor. Cell	●	7.00"	7.00"	7.00"	7.00"	7.00"	7.00"	7.00"	7.00"	7.00"	7.00"
	■	53.58"	54.58"	55.58"	36.08"	36.58"	37.58"	77.08"	89.08"	65.08"	77.08"
	◆	70.68"	70.38"	70.38"	52.85"	53.38"	54.38"	93.88"	105.88"	81.88"	93.88"
B 4 Light PAR20MH with 2 Center Fluor. Cells	●	7.00"	7.00"	7.00"	7.00"	7.00"	7.00"	7.00"	7.00"	7.00"	7.00"
	■	79.18"	79.18"	79.18"	44.18"	45.18"	47.18"	126.18"	150.18"	102.18"	126.18"
	◆	95.98"	95.98"	95.98"	60.98"	61.98"	63.98"	142.98"	166.98"	118.98"	142.98"
C 2 Light PAR20MH with 2 Outer Fluor. Cells	●	7.00"	7.00"	7.00"	7.00"	7.00"	7.00"	7.00"	7.00"	7.00"	7.00"
	■	65.18"	65.18"	65.18"	30.18"	31.18"	33.18"	112.18"	136.18"	88.18"	112.18"
	◆	81.98"	81.98"	81.98"	46.98"	47.98"	49.98"	128.98"	152.98"	104.48"	128.98"
D 2 Light PAR20MH with 2 Alternate Fluor. Cells	●	7.00"	7.00"	7.00"	7.00"	7.00"	7.00"	7.00"	7.00"	7.00"	7.00"
	■	65.18"	65.18"	65.18"	30.18"	31.18"	33.18"	112.18"	136.18"	88.18"	112.18"
	◆	81.98"	81.98"	81.98"	46.98"	47.98"	49.98"	128.98"	152.98"	104.48"	128.98"
E 2 Light PAR20MH with 2 Center Fluor. Cells	●	7.00"	7.00"	7.00"	7.00"	7.00"	7.00"	7.00"	7.00"	7.00"	7.00"
	■	65.18"	65.18"	65.18"	30.18"	31.18"	33.18"	112.18"	136.18"	88.18"	112.18"
	◆	81.98"	81.98"	81.98"	46.98"	47.98"	49.98"	128.98"	152.98"	104.48"	128.98"
F 2 Light PAR20MH with 1 Center Fluor. Cell	●	7.00"	7.00"	7.00"	7.00"	7.00"	7.00"	7.00"	7.00"	7.00"	7.00"
	■	39.59"	39.59"	39.59"	22.09"	22.59"	23.59"	63.09"	75.09"	51.09"	63.09"
	◆	53.39"	53.39"	53.39"	38.89"	39.39"	40.39"	79.89"	91.89"	67.89"	79.89"
G 2 Light PAR20MH with 1 Fluor. Cell	●	7.00"	7.00"	7.00"	7.00"	7.00"	7.00"	7.00"	7.00"	7.00"	7.00"
	■	39.59"	39.59"	39.59"	22.09"	22.59"	23.59"	63.09"	75.09"	51.09"	63.09"
	◆	53.39"	53.39"	53.39"	38.89"	39.39"	40.39"	79.89"	91.89"	67.89"	79.89"
H 2 Light PAR20MH with 2 Fluor. Cells	●	7.00"	7.00"	7.00"	7.00"	7.00"	7.00"	7.00"	7.00"	7.00"	7.00"
	■	65.18"	65.18"	65.18"	30.18"	31.18"	33.18"	112.18"	136.18"	88.18"	112.18"
	◆	81.98"	81.98"	81.98"	46.98"	47.98"	49.98"	128.98"	152.98"	104.48"	128.98"
I 1 Light PAR20MH with 1 Fluor. Cell	●	7.00"	7.00"	7.00"	7.00"	7.00"	7.00"	7.00"	7.00"	7.00"	7.00"
	■	32.59"	32.59"	32.59"	15.09"	15.59"	16.59"	56.09"	68.09"	44.09"	56.09"
	◆	42.39"	42.39"	42.39"	24.89"	25.39"	28.39"	67.89"	79.89"	55.89"	67.89"
J 1 Light PAR20MH with 2 Fluor. Cells	●	7.00"	7.00"	7.00"	7.00"	7.00"	7.00"	7.00"	7.00"	7.00"	7.00"
	■	58.19"	58.19"	58.19"	23.19"	24.19"	26.19"	105.19"	129.19"	81.19"	105.19"
	◆	74.99"	74.99"	74.99"	39.99"	40.99"	42.99"	121.99"	145.99"	97.99"	121.99"
K 4 Light PAR20MH Double Wide with 2 Fluor. Cells	●	13.99"	13.99"	13.99"	13.99"	13.99"	13.99"	13.99"	13.99"	13.99"	13.99"
	■	39.59"	39.59"	39.59"	22.09"	22.59"	23.59"	63.09"	75.09"	51.09"	63.09"
	◆	53.39"	53.39"	53.39"	38.89"	39.39"	40.39"	79.89"	91.89"	67.89"	79.89"
L 2 Light PAR20MH Double Wide with 2 Fluor. Cells	●	13.99"	13.99"	13.99"	13.99"	13.99"	13.99"	13.99"	13.99"	13.99"	13.99"
	■	32.59"	32.59"	32.59"	15.09"	15.59"	16.59"	56.09"	68.09"	44.09"	56.09"
	◆	42.39"	42.39"	42.39"	24.89"	25.39"	28.39"	67.89"	79.89"	55.89"	67.89"

Optional Accessories - See page 216 for details.

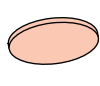
For fluorescent accessories see page 172.

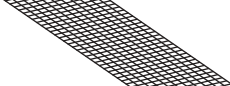
					
Baffle	Snoots	Louvers	Lenses	Parabolic Louvers	Diffusers



CR230M39 A T535 BK WH 277 (Shown with parabolic louver)

COMBO CLASSIC RECESSED PAR30MH METAL HALIDE

- Standard new construction fixture with 3/4" trim or trimless
- Combines the use of PAR30 Metal Halide lamps with a choice of fluorescent lamp sources in many fixture configuration styles.

FIXTURE CONFIGURATIONS

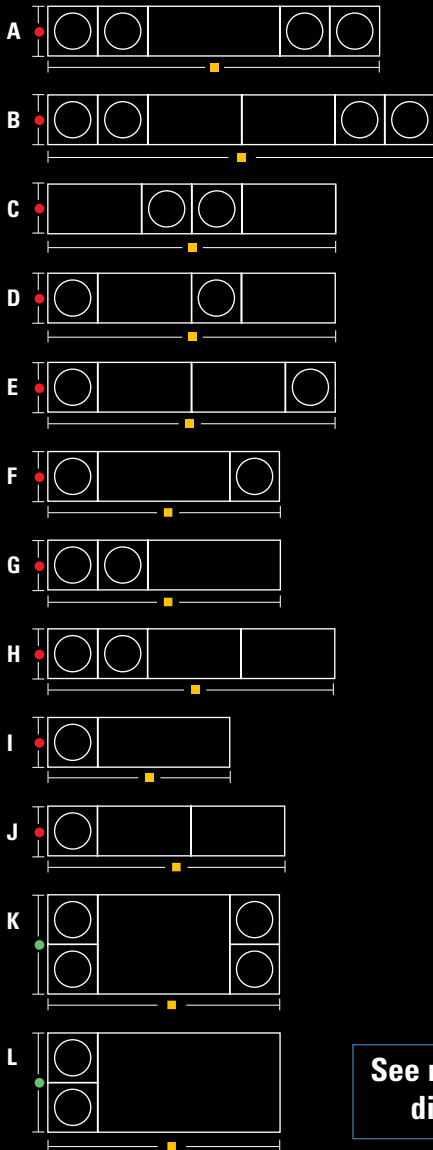

See next page for dimensions

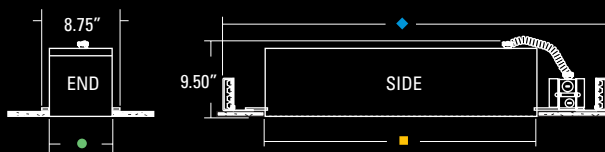

ORDERING

1

	Item #	Description
FIXTURE	CR230M39	Combo Classic Recessed PAR30MH 39 watts
	CR230M70	Combo Classic Recessed PAR30MH 70 watts

2

	Item #	Description
FIXTURE CONFIGURATION	A	4 Light PAR30MH with 1 Center Fluor. Cell
	B	4 Light PAR30MH with 2 Center Fluor. Cells
	C	2 Light PAR30MH with 2 Outer Fluor. Cells
	D	2 Light PAR30MH with 2 Alternate Fluor. Cells
	E	2 Light PAR30MH with 2 Center Fluor. Cells
	F	2 Light PAR30MH with 1 Center Fluor. Cell
	G	2 Light PAR30MH with 1 Fluor. Cell
	H	2 Light PAR30MH with 2 Fluor. Cells
	I	1 Light PAR30MH with 1 Fluor. Cell
	J	1 Light PAR30MH with 2 Fluor. Cells
	K	4 Lt. PAR30MH Double Wide with 2 Fluor. Cells
	L	2 Lt. PAR30MH Double Wide with 2 Fluor. Cells

3

	Item #	Description	Item #	Description
FLUORESCENT CELL	BX40	40 watt BIAX®	T528	28 watt T5
	BX50	50 watt BIAX®	T535	35 watt T5
	PLL80	80 watt PL-L	T5H039	39 watt T5HO
	PLT26	26 watt PL-T	T5H054	54 watt T5HO
	PLT32	32 watt PL-T		
	PLT42	42 watt PL-T		

4

	Item #	Description
INTERIOR	BK	Black
	WH	White
	S	Industrial Silver
	PT	Custom (Specify)

5

	Item #	Description
TRIM	BK	Black
	WH	White
	S	Industrial Silver
	PT	Custom (Specify)
	TR	Trimless (NO TRIM)

6

	Item #	Description
VOLTAGE	120	120 Volts
	277	277 Volts

Ordering Example

FIXTURE TYPE	CONFIGURATION	FLUORESCENT CELL	INTERIOR	TRIM	VOLTS
CR230M39	A	T535	BK	WH	277

Combo Classic Recessed Mount, Two light 39 Watt PAR30MH with One 35 Watt T5, Black Interior, White trim, 277 volts

- Standard new construction fixture offered with 3/4" trim or as a trimless fixture
- Plaster frame can accommodate 1/2" to 1" ceiling thickness
- Includes butterfly brackets for commercial installations
- Aromat® Electronic Ballast





- Fluorescent cells available with a wide array of accessories such as high transmission overlays and parabolic louvers (see page 172)
- Custom configurations are available (Consult RSA Customer Service)
- Also available in Surface Mounted Models (see page 150 - 171)

COMBO CLASSIC PAR30MH RECESSED FIXTURE CONFIGURATION DIMENSIONS

PAR30MH Fixture Configuration		BX40	BX50	PLL80	PLT26	PLT32	PLT42	T528	T535	T5HO39	T5HO54
A 4 Light PAR30MH with 1 Center Fluor. Cell	●	7.00"	7.00"	7.00"	7.00"	7.00"	7.00"	7.00"	7.00"	7.00"	7.00"
	■	53.58"	54.58"	55.58"	36.08"	36.58"	37.58"	77.08"	89.08"	65.08"	77.08"
	◆	70.68"	70.38"	70.38"	52.85"	53.38"	54.38"	93.88"	105.88"	81.88"	93.88"
B 4 Light PAR30MH with 2 Center Fluor. Cells	●	7.00"	7.00"	7.00"	7.00"	7.00"	7.00"	7.00"	7.00"	7.00"	7.00"
	■	79.18"	79.18"	79.18"	44.18"	45.18"	47.18"	126.18"	150.18"	102.18"	126.18"
	◆	95.98"	95.98"	95.98"	60.98"	61.98"	63.98"	142.98"	166.98"	118.98"	142.98"
C 2 Light PAR30MH with 2 Outer Fluor. Cells	●	7.00"	7.00"	7.00"	7.00"	7.00"	7.00"	7.00"	7.00"	7.00"	7.00"
	■	65.18"	65.18"	65.18"	30.18"	31.18"	33.18"	112.18"	136.18"	88.18"	112.18"
	◆	81.98"	81.98"	81.98"	46.98"	47.98"	49.98"	128.98"	152.98"	104.48"	128.98"
D 2 Light PAR30MH with 2 Alternate Fluor. Cells	●	7.00"	7.00"	7.00"	7.00"	7.00"	7.00"	7.00"	7.00"	7.00"	7.00"
	■	65.18"	65.18"	65.18"	30.18"	31.18"	33.18"	112.18"	136.18"	88.18"	112.18"
	◆	81.98"	81.98"	81.98"	46.98"	47.98"	49.98"	128.98"	152.98"	104.48"	128.98"
E 2 Light PAR30MH with 2 Center Fluor. Cells	●	7.00"	7.00"	7.00"	7.00"	7.00"	7.00"	7.00"	7.00"	7.00"	7.00"
	■	65.18"	65.18"	65.18"	30.18"	31.18"	33.18"	112.18"	136.18"	88.18"	112.18"
	◆	81.98"	81.98"	81.98"	46.98"	47.98"	49.98"	128.98"	152.98"	104.48"	128.98"
F 2 Light PAR30MH with 1 Center Fluor. Cell	●	7.00"	7.00"	7.00"	7.00"	7.00"	7.00"	7.00"	7.00"	7.00"	7.00"
	■	39.59"	39.59"	39.59"	22.09"	22.59"	23.59"	63.09"	75.09"	51.09"	63.09"
	◆	53.39"	53.39"	53.39"	38.89"	39.39"	40.39"	79.89"	91.89"	67.89"	79.89"
G 2 Light PAR30MH with 1 Fluor. Cell	●	7.00"	7.00"	7.00"	7.00"	7.00"	7.00"	7.00"	7.00"	7.00"	7.00"
	■	39.59"	39.59"	39.59"	22.09"	22.59"	23.59"	63.09"	75.09"	51.09"	63.09"
	◆	53.39"	53.39"	53.39"	38.89"	39.39"	40.39"	79.89"	91.89"	67.89"	79.89"
H 2 Light PAR30MH with 2 Fluor. Cells	●	7.00"	7.00"	7.00"	7.00"	7.00"	7.00"	7.00"	7.00"	7.00"	7.00"
	■	65.18"	65.18"	65.18"	30.18"	31.18"	33.18"	112.18"	136.18"	88.18"	112.18"
	◆	81.98"	81.98"	81.98"	46.98"	47.98"	49.98"	128.98"	152.98"	104.48"	128.98"
I 1 Light PAR30MH with 1 Fluor. Cell	●	7.00"	7.00"	7.00"	7.00"	7.00"	7.00"	7.00"	7.00"	7.00"	7.00"
	■	32.59"	32.59"	32.59"	15.09"	15.59"	16.59"	56.09"	68.09"	44.09"	56.09"
	◆	42.39"	42.39"	42.39"	24.89"	25.39"	28.39"	67.89"	79.89"	55.89"	67.89"
J 1 Light PAR30MH with 2 Fluor. Cells	●	7.00"	7.00"	7.00"	7.00"	7.00"	7.00"	7.00"	7.00"	7.00"	7.00"
	■	58.19"	58.19"	58.19"	23.19"	24.19"	26.19"	105.19"	129.19"	81.19"	105.19"
	◆	74.99"	74.99"	74.99"	39.99"	40.99"	42.99"	121.99"	145.99"	97.99"	121.99"
K 4 Light PAR30MH Double Wide with 2 Fluor. Cells	●	13.99"	13.99"	13.99"	13.99"	13.99"	13.99"	13.99"	13.99"	13.99"	13.99"
	■	39.59"	39.59"	39.59"	22.09"	22.59"	23.59"	63.09"	75.09"	51.09"	63.09"
	◆	53.39"	53.39"	53.39"	38.89"	39.39"	40.39"	79.89"	91.89"	67.89"	79.89"
L 2 Light PAR30MH Double Wide with 2 Fluor. Cells	●	13.99"	13.99"	13.99"	13.99"	13.99"	13.99"	13.99"	13.99"	13.99"	13.99"
	■	32.59"	32.59"	32.59"	15.09"	15.59"	16.59"	56.09"	68.09"	44.09"	56.09"
	◆	42.39"	42.39"	42.39"	24.89"	25.39"	28.39"	67.89"	79.89"	55.89"	67.89"

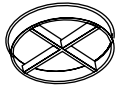
Optional Accessories - See page 216 for details.

For fluorescent accessories see page 172.

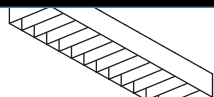
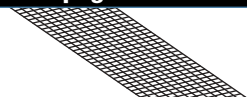
					
Baffle	Snoots	Louvers	Lenses	Parabolic Louvers	Diffusers

COMBO CLASSIC RECESSED PAR38MH METAL HALIDE

- Standard new construction fixture with 3/4" trim or trimless
- Combines the use of PAR38 Metal Halide lamps with a choice of fluorescent lamp sources in many fixture configuration styles.

FIXTURE CONFIGURATIONS

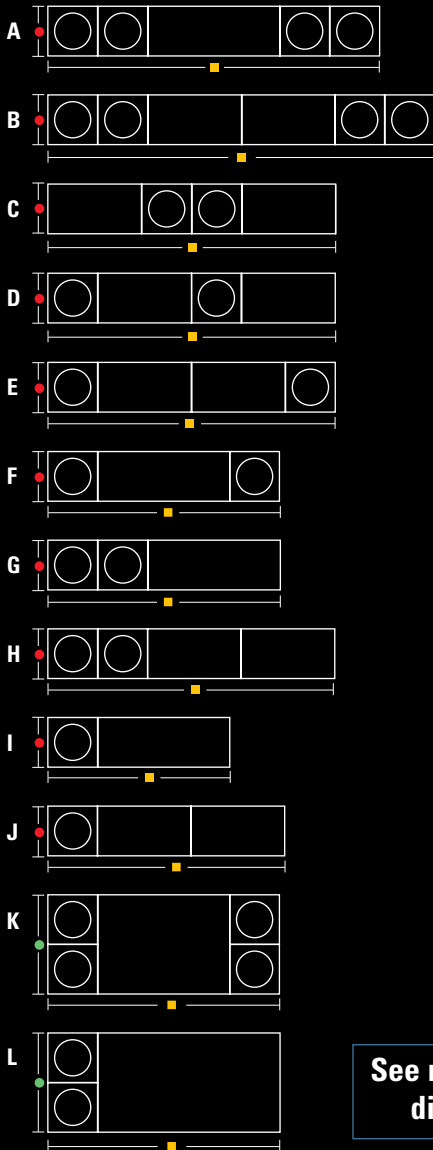

See next page for dimensions

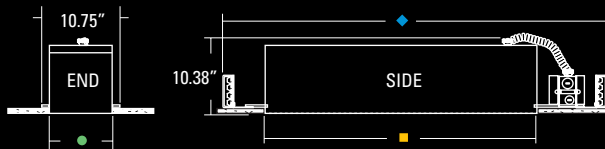

CR338M70 | PLL80 BK BK 120 (Shown with parabolic louver)

ORDERING

Item #	Description
CR338M70	Combo Classic Recessed PAR38MH 70 watts
CR338M100	Combo Classic Recessed PAR38MH 100 watts

Item #	Description
A	4 Light PAR38MH with 1 Center Fluor. Cell
B	4 Light PAR38MH with 2 Center Fluor. Cells
C	2 Light PAR38MH with 2 Outer Fluor. Cells
D	2 Light PAR38MH with 2 Alternate Fluor. Cells
E	2 Light PAR38MH with 2 Center Fluor. Cells
F	2 Light PAR38MH with 1 Center Fluor. Cell
G	2 Light PAR38MH with 1 Fluor. Cell
H	2 Light PAR38MH with 2 Fluor. Cells
I	1 Light PAR38MH with 1 Fluor. Cell
J	1 Light PAR38MH with 2 Fluor. Cells
K	4 Lt. PAR38MH Double Wide with 2 Fluor. Cells
L	2 Lt. PAR38MH Double Wide with 2 Fluor. Cells

Item #	Description	Item #	Description
BX40	40 watt BIAX®	T528	28 watt T5
BX50	50 watt BIAX®	T535	35 watt T5
PLL80	80 watt PL-L	T5H039	39 watt T5HO
PLT26	26 watt PL-T	T5H054	54 watt T5HO
PLT32	32 watt PL-T		
PLT42	42 watt PL-T		

Item #	Description
BK	Black
WH	White
S	Industrial Silver
PT	Custom (Specify)

Item #	Description
BK	Black
WH	White
S	Industrial Silver
PT	Custom (Specify)
TR	Trimless (NO TRIM)

Item #	Description
120	120 Volts
277	277 Volts

Ordering Example

FIXTURE TYPE	CONFIGURATION	FLUORESCENT CELL	INTERIOR	TRIM	VOLTS
CR338M70	I	PLL80	BK	BK	120

Combo Classic Recessed Mount, One light 70 Watt PAR38MH with One 80 Watt PLL, Black Interior, Black Trim, 120 volts

- Standard new construction fixture offered with 3/4" trim or as a trimless fixture
- Plaster frame can accommodate 1/2" to 1" ceiling thickness
- Includes butterfly brackets for commercial installations
- Aromat® Electronic Ballast





- Fluorescent cells available with a wide array of accessories such as high transmission overlays and parabolic louvers (see page 172)
- Custom configurations are available (Consult RSA Customer Service)
- Also available in Surface Mounted Models (see page 150 - 171)

COMBO CLASSIC PAR38MH RECESSED FIXTURE CONFIGURATION DIMENSIONS

PAR38MH Fixture Configuration		BX40	BX50	PLL80	PLT26	PLT32	PLT42	T528	T535	T5HO39	T5HO54
A 4 Light PAR38MH with 1 Center Fluor. Cell	●	8.90"	8.90"	8.90"	8.90"	8.90"	8.90"	8.90"	8.90"	8.90"	8.90"
	■	61.68"	61.68"	61.68"	43.68"	44.18"	45.18"	84.68"	96.68"	72.68"	84.68"
	◆	77.98"	77.98"	77.98"	60.48"	60.98"	61.98"	101.48"	113.48"	89.48"	101.48"
B 4 Light PAR38MH with 2 Center Fluor. Cells	●	8.90"	8.90"	8.90"	8.90"	8.90"	8.90"	8.90"	8.90"	8.90"	8.90"
	■	86.78"	86.78"	86.78"	51.78"	52.78"	54.78"	133.78"	157.78"	109.78"	133.78"
	◆	103.58"	103.58"	103.58"	68.58"	69.58"	71.58"	150.58"	174.58"	126.58"	150.58"
C 2 Light PAR38MH with 2 Outer Fluor. Cells	●	8.90"	8.90"	8.90"	8.90"	8.90"	8.90"	8.90"	8.90"	8.90"	8.90"
	■	68.98"	68.98"	68.98"	33.98"	34.98"	36.98"	115.98"	139.98"	91.98"	115.98"
	◆	85.78"	85.78"	85.78"	50.78"	51.78"	53.78"	132.78"	156.78"	108.78"	132.78"
D 2 Light PAR38MH with 2 Alternate Fluor. Cells	●	8.90"	8.90"	8.90"	8.90"	8.90"	8.90"	8.90"	8.90"	8.90"	8.90"
	■	68.98"	68.98"	68.98"	33.98"	34.98"	36.98"	115.98"	139.98"	91.98"	115.98"
	◆	85.78"	85.78"	85.78"	50.78"	51.78"	53.78"	132.78"	156.78"	108.78"	132.78"
E 2 Light PAR38MH with 2 Center Fluor. Cells	●	8.90"	8.90"	8.90"	8.90"	8.90"	8.90"	8.90"	8.90"	8.90"	8.90"
	■	68.98"	68.98"	68.98"	33.98"	34.98"	36.98"	115.98"	139.98"	91.98"	115.98"
	◆	85.78"	85.78"	85.78"	50.78"	51.78"	53.78"	132.78"	156.78"	108.78"	132.78"
F 2 Light PAR38MH with 1 Center Fluor. Cell	●	8.90"	8.90"	8.90"	8.90"	8.90"	8.90"	8.90"	8.90"	8.90"	8.90"
	■	43.39"	43.39"	43.39"	25.89"	26.39"	27.39"	66.89"	78.89"	54.89"	66.89"
	◆	60.19"	60.19"	60.19"	42.69"	43.19"	44.19"	83.69"	95.69"	71.69"	83.69"
G 2 Light PAR38MH with 1 Fluor. Cell	●	8.90"	8.90"	8.90"	8.90"	8.90"	8.90"	8.90"	8.90"	8.90"	8.90"
	■	43.39"	43.39"	43.39"	25.89"	26.39"	27.39"	66.89"	78.89"	54.89"	66.89"
	◆	60.19"	60.19"	60.19"	42.69"	43.19"	44.19"	83.69"	95.69"	71.69"	83.69"
H 2 Light PAR38MH with 2 Fluor. Cells	●	8.90"	8.90"	8.90"	8.90"	8.90"	8.90"	8.90"	8.90"	8.90"	8.90"
	■	68.98"	68.98"	68.98"	33.98"	34.98"	36.98"	115.98"	139.98"	91.98"	115.98"
	◆	85.78"	85.78"	85.78"	50.78"	51.78"	53.78"	132.78"	156.78"	108.78"	132.78"
I 1 Light PAR38MH with 1 Fluor. Cell	●	8.90"	8.90"	8.90"	8.90"	8.90"	8.90"	8.90"	8.90"	8.90"	8.90"
	■	34.49"	34.49"	34.49"	16.99"	17.49"	18.49"	57.99"	69.99"	45.99"	57.99"
	◆	46.29"	46.29"	46.29"	28.79"	29.29"	30.29"	69.79"	81.79"	57.79"	74.79"
J 1 Light PAR38MH with 2 Fluor. Cells	●	8.90"	8.90"	8.90"	8.90"	8.90"	8.90"	8.90"	8.90"	8.90"	8.90"
	■	60.09"	60.09"	60.09"	25.09"	26.09"	28.09"	107.09"	131.09"	83.09"	107.09"
	◆	76.89"	76.89"	76.89"	41.89"	42.89"	44.89"	123.89"	147.89"	99.89"	123.89"
K 4 Light PAR38MH Double Wide with 2 Fluor. Cells	●	17.79"	17.79"	17.79"	17.79"	17.79"	17.79"	17.79"	17.79"	17.79"	17.79"
	■	43.39"	43.39"	43.39"	25.89"	26.39"	27.39"	66.89"	78.89"	54.89"	66.89"
	◆	60.19"	60.19"	60.19"	42.69"	43.19"	44.19"	83.69"	95.69"	71.69"	83.69"
L 2 Light PAR38MH Double Wide with 2 Fluor. Cells	●	17.79"	17.79"	17.79"	17.79"	17.79"	17.79"	17.79"	17.79"	17.79"	17.79"
	■	34.49"	34.49"	34.49"	16.99"	17.49"	18.49"	57.99"	69.99"	45.99"	57.99"
	◆	46.29"	46.29"	46.29"	28.79"	29.29"	30.29"	69.79"	81.79"	57.79"	74.79"

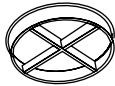
Optional Accessories - See page 216 for details.

For fluorescent accessories see page 172.

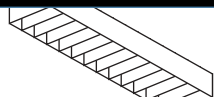
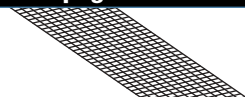
					
Baffle	Snoots	Louvers	Lenses	Parabolic Louvers	Diffusers

COMBO CLASSIC RECESSED T4 G8.5 METAL HALIDE

- Standard new construction fixture with 3/4" trim or trimless
- Combines the use of T4 Metal Halide lamp and a high performance aluminum reflector with a choice of fluorescent lamp sources in many fixture configuration styles.

FIXTURE CONFIGURATIONS

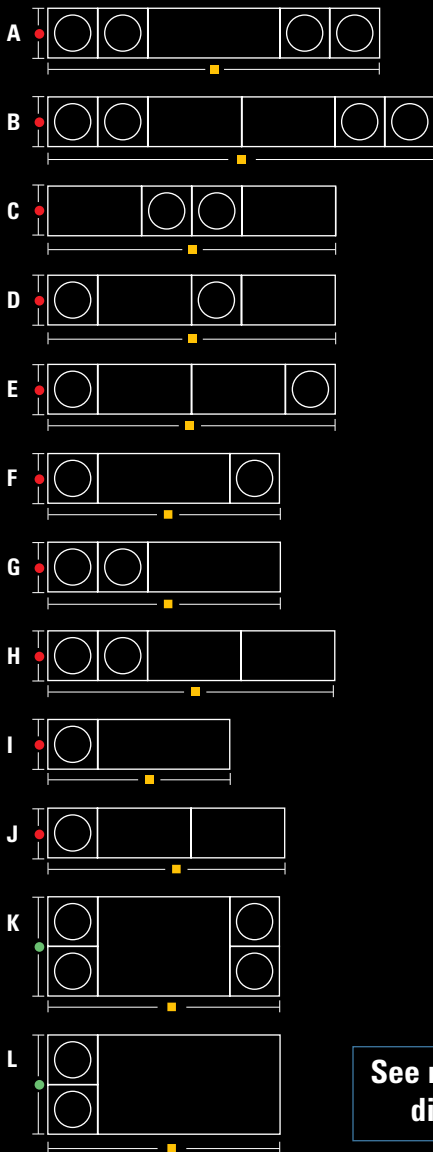

See next page for dimensions

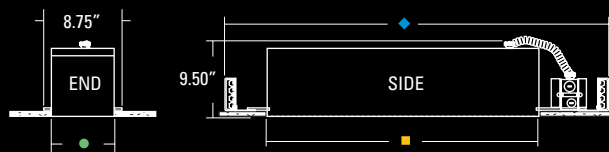

CR2TC35 D T5H039 BK WH 27 120 (Shown with textured white diffuser)

ORDERING

1	FIXTURE	Item #	Description		
		CR2TC35	Combo Classic Recessed T4 G8.5MH 35 watts		
		CR2TC70	Combo Classic Recessed T4 G8.5MH 70 watts		
2	FIXTURE CONFIGURATION	Item #	Description		
		A	4 Light T4MH with 1 Center Fluor. Cell		
		B	4 Light T4MH with 2 Center Fluor. Cells		
		C	2 Light T4MH with 2 Outer Fluor. Cells		
		D	2 Light T4MH with 2 Alternate Fluor. Cells		
		E	2 Light T4MH with 2 Center Fluor. Cells		
		F	2 Light T4MH with 1 Center Fluor. Cell		
		G	2 Light T4MH with 1 Fluor. Cell		
		H	2 Light T4MH with 2 Fluor. Cells		
		I	1 Light T4MH with 1 Fluor. Cell		
		J	1 Light T4MH with 2 Fluor. Cells		
		K	4 Light T4MH Double Wide with 2 Fluor. Cells		
L	2 Light T4MH Double Wide with 2 Fluor. Cells				
3	FLUOR. CELL	Item #	Description	Item #	Description
		BX40	40 watt BIAx®	PLT42	42 watt PL-T
		BX50	50 watt BIAx®	T528	28 watt T5
		PLL80	80 watt PL-L	T535	35 watt T5
		PLT26	26 watt PL-T	T5H039	39 watt T5H0
		PLT32	32 watt PL-T	T5H054	54 watt T5H0
4	INTERIOR	Item #	Description		
		BK	Black		
		WH	White		
		S	Industrial Silver		
PT	Custom (Specify)				
5	TRIM	Item #	Description		
		BK	Black		
		WH	White		
		S	Industrial Silver		
		PT	Custom (Specify)		
TR	Trimless (NO TRIM)				
6	DISTRIBUTION	Item #	Description		
		15	Reflector w/ 15° Narrow Spread		
		27	Reflector w/ 27° Medium Spread		
55	Reflector w/ 55° Wide Spread				
<i>See page 217 for details</i>					
7	VOLTAGE	Item #	Description		
		120	120 Volts		
277	277 Volts				

Ordering Example

FIXTURE TYPE	CONFIGURATION	FLUORESCENT CELL	INTERIOR	TRIM	DIST.	VOLTS
CR2TC35	D	T5H039	BK	WH	27	120

Combo Classic Recessed Mount, Two light 35 Watt T4 G8.5MH with Two 39 Watt T5H0, Black Interior, White Trim, 27° Distribution, 120 volts

- Standard new construction fixture offered with 3/4" trim or as a trimless fixture
- Plaster frame can accommodate 1/2" to 1" ceiling thickness
- Includes butterfly brackets for commercial installations
- Aromat® Electronic Ballast





- Fluorescent cells available with a wide array of accessories such as high transmission overlays and parabolic louvers (see page 172)
- Custom configurations are available (Consult RSA Customer Service)
- Also available in Surface Mounted Models (see page 150 - 171)

COMBO CLASSIC T4MH RECESSED FIXTURE CONFIGURATION DIMENSIONS

T4 G8.5MH Fixture Configuration		BX40	BX50	PLL80	PLT26	PLT32	PLT42	T528	T535	T5HO39	T5HO54
A 4 Light T4MH with 1 Center Fluor. Cell	●	7.00"	7.00"	7.00"	7.00"	7.00"	7.00"	7.00"	7.00"	7.00"	7.00"
	■	53.58"	54.58"	55.58"	36.08"	36.58"	37.58"	77.08"	89.08"	65.08"	77.08"
	◆	70.68"	70.38"	70.38"	52.85"	53.38"	54.38"	93.88"	105.88"	81.88"	93.88"
B 4 Light T4MH with 2 Center Fluor. Cells	●	7.00"	7.00"	7.00"	7.00"	7.00"	7.00"	7.00"	7.00"	7.00"	7.00"
	■	79.18"	79.18"	79.18"	44.18"	45.18"	47.18"	126.18"	150.18"	102.18"	126.18"
	◆	95.98"	95.98"	95.98"	60.98"	61.98"	63.98"	142.98"	166.98"	118.98"	142.98"
C 2 Light T4MH with 2 Outer Fluor. Cells	●	7.00"	7.00"	7.00"	7.00"	7.00"	7.00"	7.00"	7.00"	7.00"	7.00"
	■	65.18"	65.18"	65.18"	30.18"	31.18"	33.18"	112.18"	136.18"	88.18"	112.18"
	◆	81.98"	81.98"	81.98"	46.98"	47.98"	49.98"	128.98"	152.98"	104.48"	128.98"
D 2 Light T4MH with 2 Alternate Fluor. Cells	●	7.00"	7.00"	7.00"	7.00"	7.00"	7.00"	7.00"	7.00"	7.00"	7.00"
	■	65.18"	65.18"	65.18"	30.18"	31.18"	33.18"	112.18"	136.18"	88.18"	112.18"
	◆	81.98"	81.98"	81.98"	46.98"	47.98"	49.98"	128.98"	152.98"	104.48"	128.98"
E 2 Light T4MH with 2 Center Fluor. Cells	●	7.00"	7.00"	7.00"	7.00"	7.00"	7.00"	7.00"	7.00"	7.00"	7.00"
	■	65.18"	65.18"	65.18"	30.18"	31.18"	33.18"	112.18"	136.18"	88.18"	112.18"
	◆	81.98"	81.98"	81.98"	46.98"	47.98"	49.98"	128.98"	152.98"	104.48"	128.98"
F 2 Light T4MH with 1 Center Fluor. Cell	●	7.00"	7.00"	7.00"	7.00"	7.00"	7.00"	7.00"	7.00"	7.00"	7.00"
	■	39.59"	39.59"	39.59"	22.09"	22.59"	23.59"	63.09"	75.09"	51.09"	63.09"
	◆	53.39"	53.39"	53.39"	38.89"	39.39"	40.39"	79.89"	91.89"	67.89"	79.89"
G 2 Light T4MH with 1 Fluor. Cell	●	7.00"	7.00"	7.00"	7.00"	7.00"	7.00"	7.00"	7.00"	7.00"	7.00"
	■	39.59"	39.59"	39.59"	22.09"	22.59"	23.59"	63.09"	75.09"	51.09"	63.09"
	◆	53.39"	53.39"	53.39"	38.89"	39.39"	40.39"	79.89"	91.89"	67.89"	79.89"
H 2 Light T4MH with 2 Fluor. Cells	●	7.00"	7.00"	7.00"	7.00"	7.00"	7.00"	7.00"	7.00"	7.00"	7.00"
	■	65.18"	65.18"	65.18"	30.18"	31.18"	33.18"	112.18"	136.18"	88.18"	112.18"
	◆	81.98"	81.98"	81.98"	46.98"	47.98"	49.98"	128.98"	152.98"	104.48"	128.98"
I 1 Light T4MH with 1 Fluor. Cell	●	7.00"	7.00"	7.00"	7.00"	7.00"	7.00"	7.00"	7.00"	7.00"	7.00"
	■	32.59"	32.59"	32.59"	15.09"	15.59"	16.59"	56.09"	68.09"	44.09"	56.09"
	◆	42.39"	42.39"	42.39"	24.89"	25.39"	28.39"	67.89"	79.89"	55.89"	67.89"
J 1 Light T4MH with 2 Fluor. Cells	●	7.00"	7.00"	7.00"	7.00"	7.00"	7.00"	7.00"	7.00"	7.00"	7.00"
	■	58.19"	58.19"	58.19"	23.19"	24.19"	26.19"	105.19"	129.19"	81.19"	105.19"
	◆	74.99"	74.99"	74.99"	39.99"	40.99"	42.99"	121.99"	145.99"	97.99"	121.99"
K 4 Light T4MH Double Wide with 2 Fluor. Cells	●	13.99"	13.99"	13.99"	13.99"	13.99"	13.99"	13.99"	13.99"	13.99"	13.99"
	■	39.59"	39.59"	39.59"	22.09"	22.59"	23.59"	63.09"	75.09"	51.09"	63.09"
	◆	53.39"	53.39"	53.39"	38.89"	39.39"	40.39"	79.89"	91.89"	67.89"	79.89"
L 2 Light T4MH Double Wide with 2 Fluor. Cells	●	13.99"	13.99"	13.99"	13.99"	13.99"	13.99"	13.99"	13.99"	13.99"	13.99"
	■	32.59"	32.59"	32.59"	15.09"	15.59"	16.59"	56.09"	68.09"	44.09"	56.09"
	◆	42.39"	42.39"	42.39"	24.89"	25.39"	28.39"	67.89"	79.89"	55.89"	67.89"

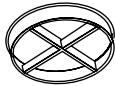
Optional Accessories - See page 216 for details.

For fluorescent accessories see page 172.

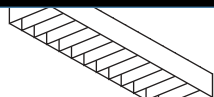
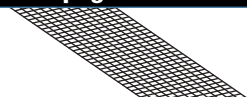
					
Baffle	Snoots	Louvers	Lenses	Parabolic Louvers	Diffusers