

12/06

## TF 4128 PLANTER



Size:	60" x 18"
Weight:	900 lbs.
Material:	Reinforced Precast Concrete.
Reinforcing:	3/8" Dia. steel rebar.
Hardware:	(4) 3/8" Threaded inserts.
Anchoring:	Optional.
Maintenance:	Rinse periodically with water & mild detergent. Re-seal annually.
Packaging:	Banded to pallet.

### Options:

Note: Options may change without notice.  
Call to confirm current options.

#### Weatherstone:

Sand - Gray - Brown - Buff - Cream  
Light Charcoal - French Gray - Brick Red  
- Souldard Green

#### Recycled Glass:

Charcoal Matrix - Sand Matrix -  
Gray Matrix - White Matrix

Custom Options Available

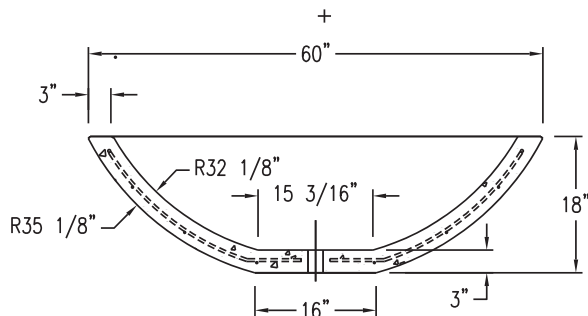
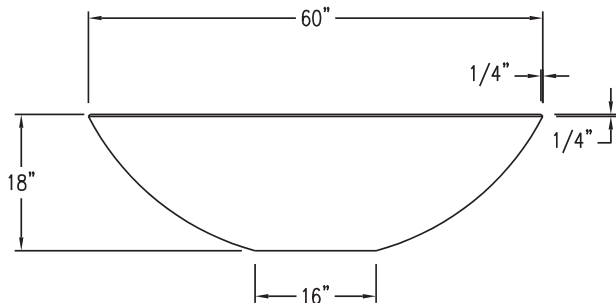
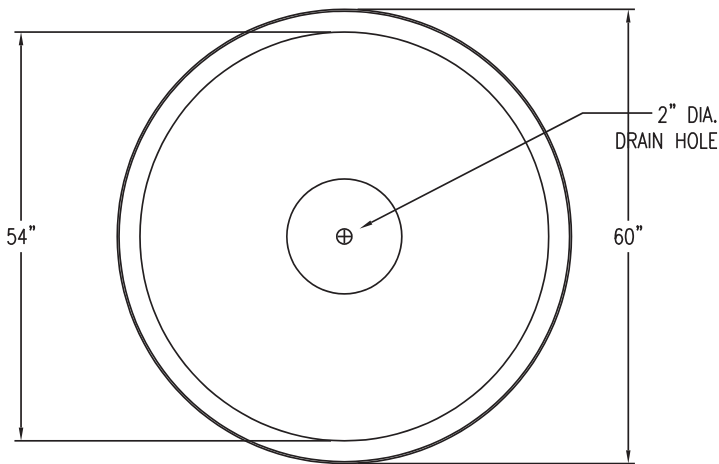

## 1.1 SUMMARY

- A. Section includes: Furnish Precast Concrete Planter indicated on drawings or specified herein.

## 1.2 REFERENCES

- A. American Society for Testing & Materials
  1. ASTM C33
  2. ASTM C150
  3. ASTM C31

## 1.5 SUBMITTALS

- A. Submit product data, shop drawings and Samples.
  1. Product Data: Manufacturer's specifications and technical data edited specifically for proposed system, including the following specific information:
    - a. Detailed specification of construction fabrication.
    - b. Manufacturer's installation instructions
    - c. Maintenance literature
    - d. Product warranty
  2. Shop Drawings: Indicate pertinent dimensions, general construction, component connections anchoring methods, hardware and installation procedures.
  3. Samples as requested by Architect.

## 1.6 QUALITY ASSURANCE

- A. Qualifications of Manufacturer: Manufacturer to be prequalified by specifier prior to bidding. Failure to comply will result in disqualification of bid. Manufacturer to have at least five years experience in the manufacturer of precast concrete planters field proven for at least five years.

## 1.10 WARRANTY

Manufacturer shall submit a written warranty for precast products for the period of two years upon acceptance of products.

## 2.1 MANUFACTURERS

- A. Acceptable manufacturer for Precast Concrete Planters to be known as Wausau Tile, Inc.  
PO Box 1520, Wausau, WI 54402-1520.  
(800) 388-8728 FAX (715) 355-4627
- B. Clarification Note: Drawings and installation specification are based on manufacturers proprietary literature from Wausau Tile, Inc. Other manufacturers shall comply with minimum levels of material and detailing indicated on drawings or specified herein.
- C. All Precast products for this project shall be of one manufacturer.

## 2.2 MATERIALS

- A. Portland Cement: ASTM C150 specifications for Portland Cement.
- B. Aggregates: All aggregates to meet ASTM C33 specifications, to be cleaned of foreign matter and properly graded to size.
- C. Coloring: Pigments used shall be inorganic, resistant to alkalinity and used as per manufacturers recommendations.