

# TF 5015 BCS72 Bench

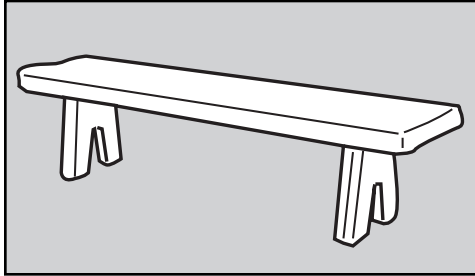

**Options:**

Note: Options may change without notice.  
Call to confirm current options.

Smooth/Stained Concrete:

Sand - Gray - Brown - Light Charcoal  
Red - Yellow - Orange - Cream - Buff - Brick Red

Custom Options Available

- Size: 72" L x 15" W x 19" H.
- Weight: 320 lbs.
- Seating Capacity: 3-4 persons.
- Material: Reinforced Precast Concrete.
- Reinforcing: 3/8" Dia. steel rebar.
- Hardware: (8) - 3/8" Dia. x 1" hex bolts.  
(12) - 3/8" Dia. threaded inserts.  
(2) - 1/2" Dia. threaded inserts.
- Anchoring: Optional.
- Maintenance: Periodically rinse with water & mild detergent,  
and re-seal annually.
- Packaging: Banded to pallet. Assembly required.

# SPECIFICATIONS

# TF 5015 BCS72 Bench

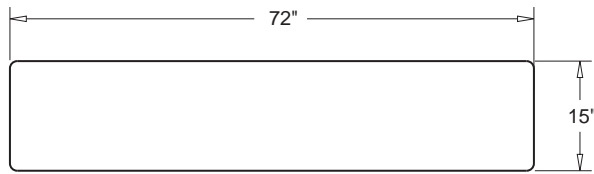

TOP VIEW

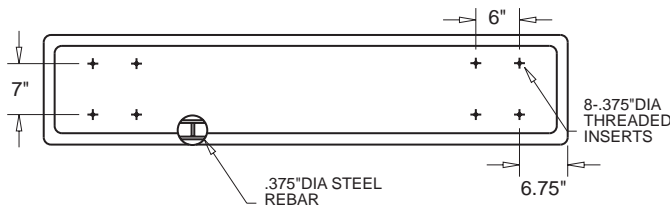

BOTTOM VIEW

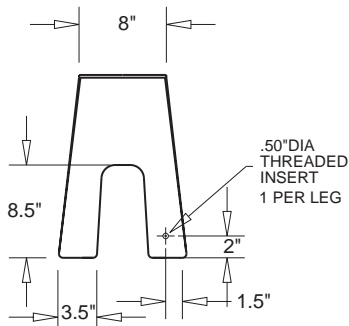

SIDE VIEW

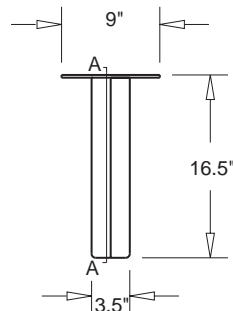

END VIEW

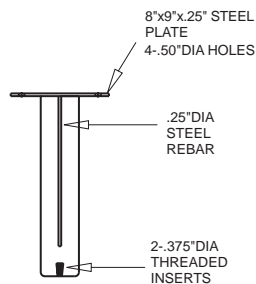

SECTION A-A

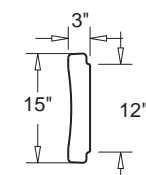

SIDE VIEW

## 1.1 SUMMARY

- A. Section includes: Furnish Precast Concrete Bench indicated on drawings or specified herein.

## 1.2 REFERENCES

- A. American Society for Testing & Material
  1. ASTM C33
  2. ASTM C150
  3. ASTM C31

## 1.5 SUBMITTALS

- A. Submit product data, shop drawings and samples.
  1. Product Data: Manufacturer's specifications and technical data edited specifically for proposed system, including the following specific information:
    - a. Detailed specification of construction fabrication.
    - b. Manufacturer's installation instructions
    - c. Maintenance literature
    - d. Product warranty
  2. Shop Drawings: Indicate pertinent dimensions, general construction, component connections anchoring methods, hardware and installation procedures.
  3. Samples as requested by Architect.

## 1.6 QUALITY ASSURANCE

- A. Qualifications of Manufacturer: Manufacturer to be prequalified by specifier prior to bidding. Failure to comply will result in disqualification of bid. Manufacturer to have at least five years experience in the manufacturer of precast concrete benches field proven for at least five years.

## 1.10 WARRANTY

Manufacturer shall submit a written warranty for precast products for the period of two years upon acceptance of products.

## 2.1 MANUFACTURERS

- A. Acceptable manufacturer for Precast Concrete Benches to be known as Wausau Tile, Inc. Terra-Form Division. P.O. Box 1520 Wausau, WI 54402-1520. (800) 388-8728 (715) 359-3121 FAX (715) 355-4627
- B. Clarification Note: Drawings and installation specification are based on manufacturers proprietary literature from Wausau Tile, Inc. Other manufacturers shall comply with minimum levels of material and detailing indicated on drawings or specified herein.

## 2.2 MATERIALS

- A. Portland Cement: ASTM C150 specifications for Portland Cement.
- B. Aggregates: All aggregates to meet ASTM C33 specifications, to be cleaned of foreign matter and properly graded to size.
- C. Coloring: All Precast products for this project shall be of one manufacturer.