

Installation Instructions

Reversing the Door Swing

(Single Door Refrigerator Models only)

Questions? Call 800.GE.CARES (800.432.2737) or Visit our Website at: ge.com
In Canada, call 1.800.561.3344 or Visit our Website at: www.geappliances.ca

IMPORTANT NOTES

When reversing the door swing:

NOTE: Door swing is not reversible on stainless steel models.

- Read the instructions all the way through before starting.
- Parts are included in the door hinge kit.
- Handle parts carefully to avoid scratching paint.
- Set screws down by their related parts to avoid using them in the wrong places.
- Provide a non-scratching work surface for the doors.

IMPORTANT: Once you begin, do not move the cabinet until door-swing reversal is completed.

These instructions are for changing the hinges from the right side to the left side—if you ever want to change the hinges back to the right side, follow these same instructions and reverse all references to left and right.

- Once door swing is finalized, ensure the logo badge is properly aligned and permanently secured to the door by removing the adhesive cover on the back side.
NOTE: A replacement logo badge is included in the hinge kit.

Unplug the refrigerator from its electrical outlet.

Empty all door shelves, including the dairy compartment.

TOOLS YOU WILL NEED



Adjustable Wrench

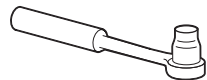

5/16" Socket Ratchet/Driver

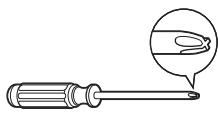

Phillips Screwdriver



Masking Tape

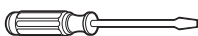

Thin-blade Screwdriver



Torx T-20 Driver

1 REMOVE THE REFRIGERATOR DOOR

- A** Tape the door shut with masking tape.

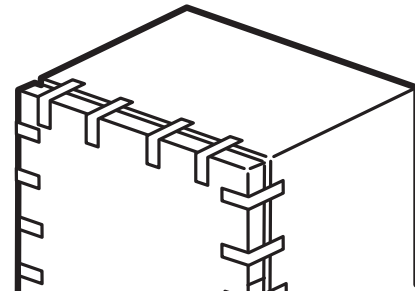

- B** Remove the hinge cover on top of the refrigerator door by carefully prying it up with a putty knife, if necessary.
- C** Using a 5/16" socket ratchet/driver, remove the bolts securing the top hinge to the cabinet. Then lift the hinge straight up to free the hinge pin from the socket in the top of the door.
- D** Carefully remove the door thimble from inside the socket. This will be used again when reinstalling the door on the other side.

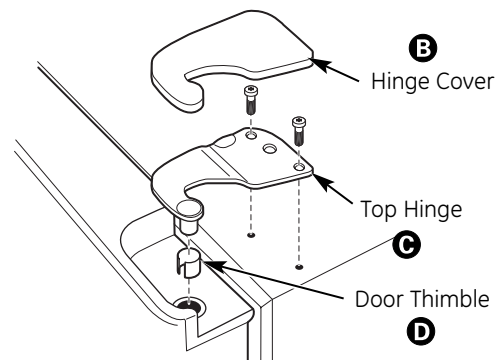

Installation Instructions

1 REMOVE THE REFRIGERATOR DOOR (cont.)

- E** Remove the tape and tilt the door away from the cabinet. Lift the door off the center hinge pin. Ensure that the plastic hinge pin thimble remains on the hinge pin or inside door hinge pin hole located in the bottom of the door.

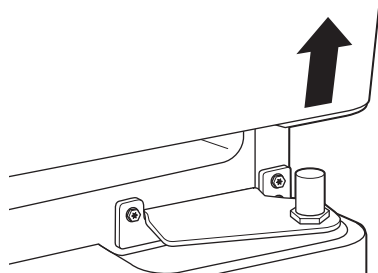

- F** Set the door on a non-scratching surface with the inside up.

2 REMOVE CENTER HINGE (For models without freezer door)

Remove the hinge pin from the hinge bracket. The hinge pin will be used again with the new hinge bracket for the other side.

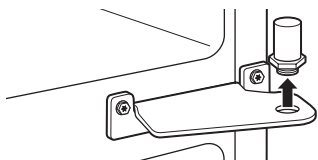

2 REMOVE THE FREEZER DOOR (For models with freezer door)

- A** Tape the door shut with masking tape.
B Remove hinge pin from hinge bracket. This will be used again with the new hinge bracket for the other side.

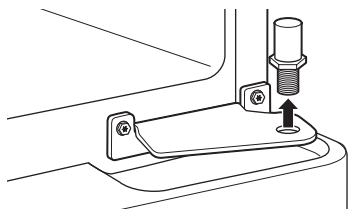

- C** Remove the tape and tilt the door away from the cabinet. Lift the door off the bottom hinge pin.

2 REMOVE THE FREEZER DOOR (For models with freezer door) (cont.)

- D** Remove the button plug from the left side of the door. Remove the door thimble from the right side of the door. Install the door thimble into the hole on the left and the button plug into the hole on the right.

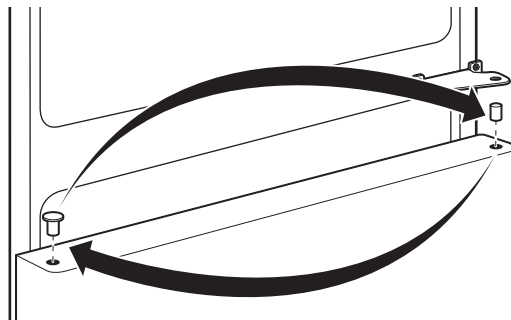

- E** Set the door on a non-scratching surface, with the inside up.

3 TRANSFER CENTER HINGE BRACKET

- A** Using a 5/16" socket ratchet/driver, remove the bolts securing the center hinge to the cabinet.

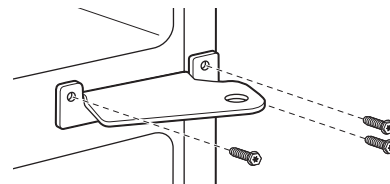

- B** Transfer the plug button and screw hole cover in the hinge holes on the left side to the right side.

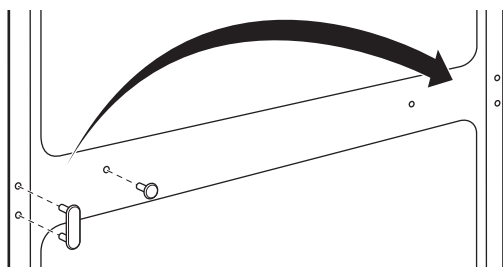

- C** Install the new center hinge bracket from the kit on the left side.

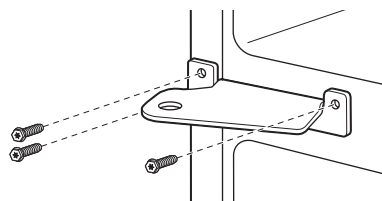

Installation Instructions

4 INSTALL CENTER HINGE PIN (For models without freezer door)

Install the hinge pin into the new hinge bracket.

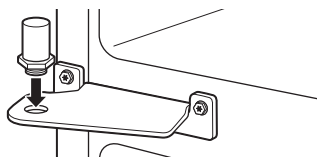

5 REMOVE BOTTOM HINGE AND LEVELING LEG (For models with freezer door)

- A** Using a 1/2" socket ratchet/driver, remove the nut and hinge pin from the hinge bracket with leveling leg. Using a 5/16" socket ratchet/driver, remove the screws from the bottom hinge bracket. These will be reinstalled on the other side.

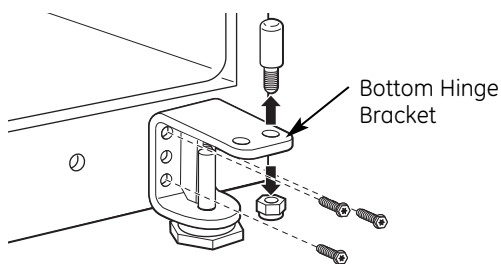

- B** Using a 5/16" socket ratchet/driver, remove the screws from the leveling leg bracket on the other side. These will be reinstalled on the opposite side.

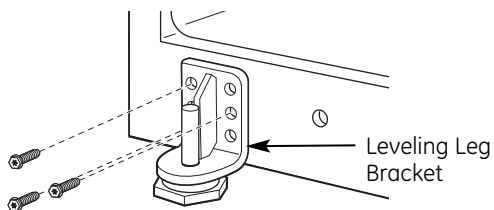

6 INSTALL BOTTOM HINGE AND LEVELING LEG (For models with freezer door)

- A** Using a 1/2" socket ratchet/driver, install the hinge pin and nut in the opposite hole on the hinge bracket with leveling leg.

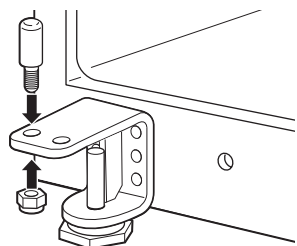

6 INSTALL BOTTOM HINGE AND LEVELING LEG (For models with freezer door) (cont.)

- B** Using a 5/16" socket ratchet/driver, install the hinge bracket with leveling leg on the left side of the refrigerator. The pin will be toward the outside of the refrigerator.

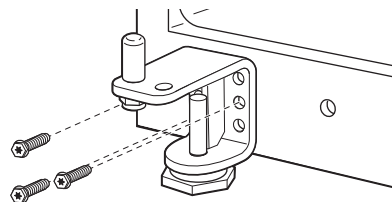

- C** Using a 5/16" socket ratchet/driver, install the leveling leg bracket on the right side of the refrigerator.

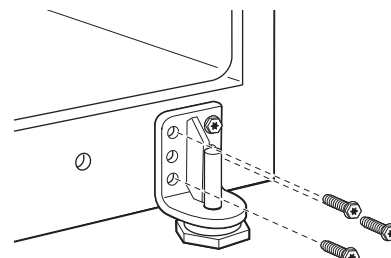

7 TRANSFER REFRIGERATOR AND FREEZER DOOR STOPS

- A** Remove the door stop on right side of the bottom of the door by removing the two screws.
- B** Move the plastic hinge hole thimble to the opposite hole.
- C** Install the door stop on the left side, making sure to line up the screw holes in the door stop with the holes in the bottom of the door.

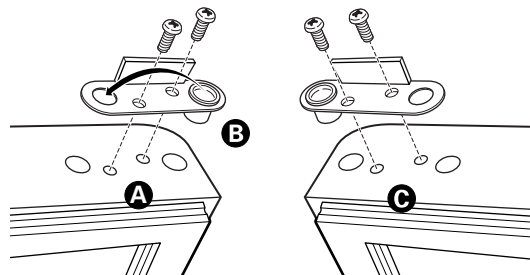

Bottom of Door (Right Side)

Bottom of Door (Left Side)

Installation Instructions

8 TRANSFER REFRIGERATOR DOOR HANDLE TO RIGHT

Refer to Remove the Fresh Food Door Handle and Attach the Fresh Food Door Handle sections for instructions.

9 REHANG FREEZER DOOR (For models with freezer door)

- A** Lower the freezer door onto the bottom hinge pin. Ensure that the plastic hinge pin thimble is on the hinge pin or inside the door hinge pin hole located in the bottom of the door.

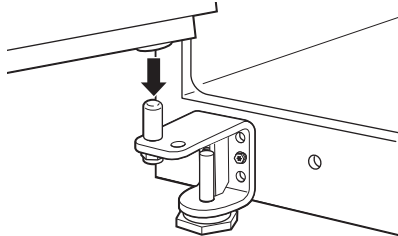

- B** Straighten the door and line it up with the center hinge bracket.
- C** Install the center hinge pin with a 3/4" socket ratchet/driver. Turn it until it extends through the hinge bracket and into the freezer door.

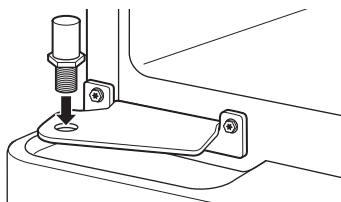

10 REHANG REFRIGERATOR DOOR

- A** Lower the refrigerator door onto the center hinge pin. Ensure that the plastic hinge pin thimble is on the center hinge pin or inside door hinge pin hole located in the bottom of the door.

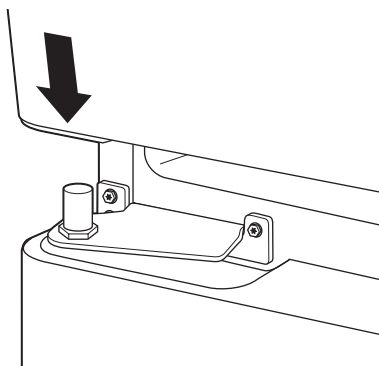

10 REHANG REFRIGERATOR DOOR (cont.)

- B** Insert the door thimble into the hinge hole on top of the refrigerator door and then insert the top hinge pin. Make sure the door is aligned with the cabinet. Attach the hinge to the top of the cabinet loosely with the bolts.
- C** Make sure the gasket on the door is flush against the cabinet and is not folded. Support the door on the handle side and make sure the door is straight and the gap between the doors is even across the front. While holding the door in place, tighten the top hinge bolts. Replace the hinge cover.

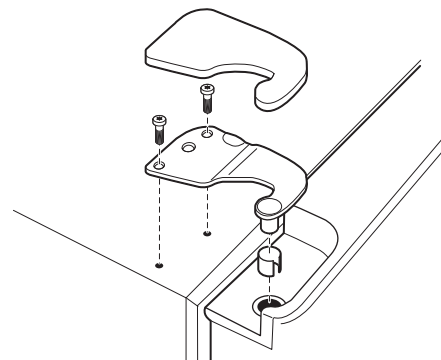

11 INSTALL THE LOGO BADGE

Remove the adhesive backing paper and align the pins on the back of the badge with the holes in the door. Apply pressure to the badge to ensure it sticks to the door.

