

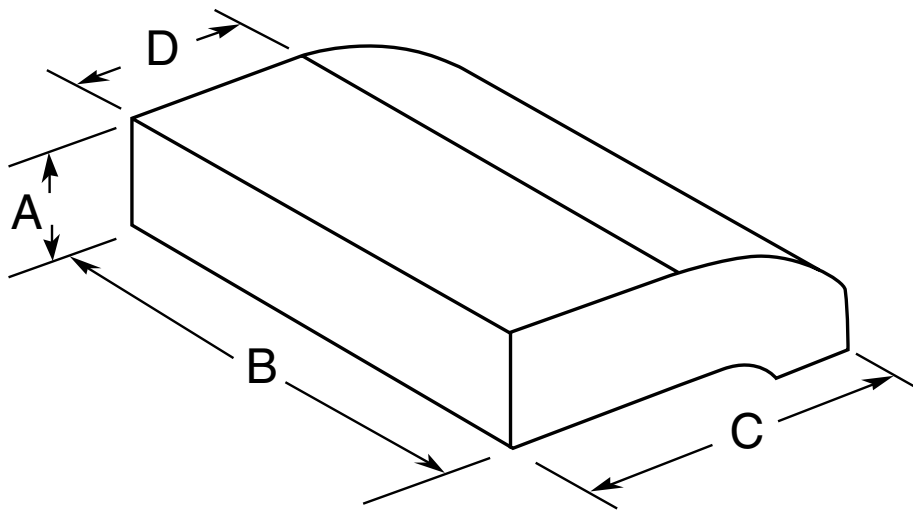

Profile™

JV565H – GE Profile™ 36" Performance Range Hood

Dimensions (in inches)



Model	A	B	C	D
JV565	4-3/4	35-7/8	20	12

Amp Rating	
120V	2.5

Installation Information: Before installing, consult installation instructions packed with product for current dimensional data. Light bulb(s) not included.

Specification Revised 5/04
220968

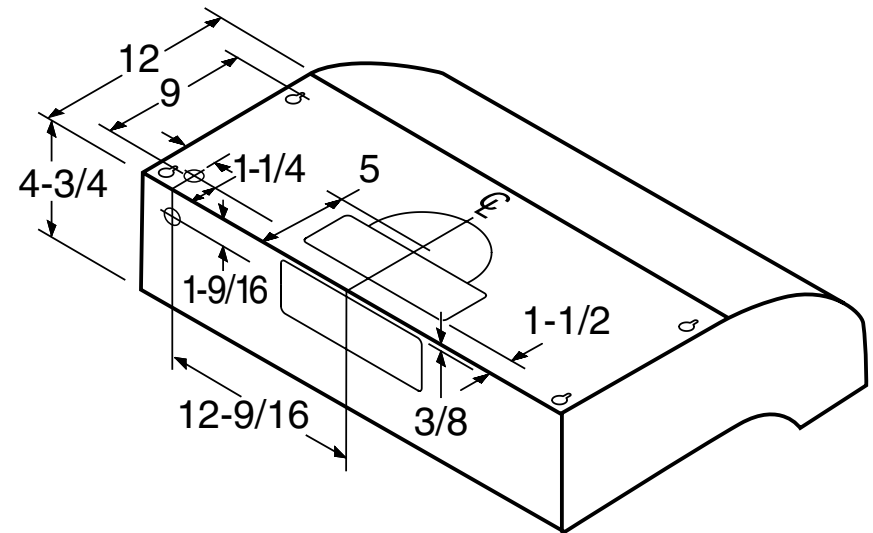

Exhaust outlet connects to 3-1/4" x 10" duct (vertically or horizontally) and 7" round (vertically). Includes rectangular damper and 7" round damper adapter.

Round damper accessory, JXDA22 available at additional cost.

JXHC1 Cord Kit – Allows a receptacle in the cabinet over the range to accommodate either an over-the-range microwave oven or a standard hood.



For answers to your Monogram®, GE Profile™ or GE® appliance questions, visit our website at GEAppliances.com or call GE Answer Center® service, 800.626.2000.



Profile™

JV565H – GE Profile™ 36" Performance Range Hood

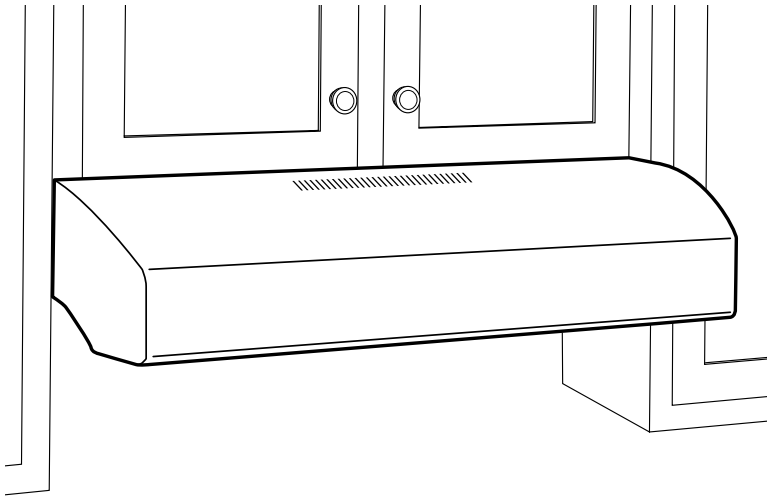

Features and Benefits

- Convertible venting – Hood configuration can be changed to fit the needs of various installation requirements.
- Vertical and rear exhaust – Provides the option of connecting duct work to either the rear or the top of the hood.
- Variable 2-speed fan control – Powerful variable speed exhaust system effectively pulls smoke and vapors out of the kitchen.
- Halogen light – Provides bright light that illuminates the cooking surface below hood.
- Removable grease filter – Durable filters can be removed for easy cleaning and maintenance.
- Round and rectangular ducting – Hood is designed to fit either standard round or rectangular duct work.
- Damper included.
- Model JV566HSS – Stainless Steel
- Model JV565HWW – White on white
- Model JV565HCC – Bisque on bisque
- Model JV565HBB – Black on black