



# Washers

**Washer Safety** .....2

**Installation Requirements**

Tools and Parts .....3

Location Requirements .....3

Electrical Requirements .....4

Remove Shipping Material .....5

**Installation Instructions**

Before You Start .....6

Drain System .....6

Connect Drain Hose .....6

Connect the Inlet Hoses .....7

Secure Drain Hose .....8

Level the Washer .....8

Complete Installation .....8

**Washer Use**

Starting Your Washer .....9

Cycles .....10

Understanding Washer Cycles .....10

Normal Sounds .....11

**Laundry Tips**

Loading .....11

**Washer Care**

Cleaning Your Washer .....12

Water Inlet Hoses .....12

Vacation, Storage, and Moving Care .12

**Troubleshooting**

Troubleshooting .....13

**Consumer Support**

Product Registration .....17

Warranty .....19

Consumer Support .....Back Cover

**Owner's Manual & Installation Instructions**

WSKS3040

**Write the model and serial numbers here:**

# \_\_\_\_\_

# \_\_\_\_\_

You can find them on a label under the lid of the washer.



# WASHER SAFETY

## Your safety and the safety of others are very important.

We have provided many important safety messages in this manual and on your appliance. Always read and obey all safety messages.



This is the safety alert symbol.

This symbol alerts you to potential hazards that can kill or hurt you and others.

All safety messages will follow the safety alert symbol and either the word “DANGER” or “WARNING.”

These words mean:

**⚠ DANGER**

You can be killed or seriously injured if you don't immediately follow instructions.

**⚠ WARNING**

You can be killed or seriously injured if you don't follow instructions.

All safety messages will tell you what the potential hazard is, tell you how to reduce the chance of injury, and tell you what can happen if the instructions are not followed.

## IMPORTANT SAFETY INSTRUCTIONS

**WARNING:** To reduce the risk of fire, electric shock, or injury to persons when using the washer, follow basic precautions, including the following:

- Read all instructions before using the washer.
- Do not wash articles that have been previously cleaned in, washed in, soaked in, or spotted with gasoline, dry-cleaning solvents, other flammable, or explosive substances as they give off vapors that could ignite or explode.
- Do not add gasoline, dry-cleaning solvents, or other flammable, or explosive substances to the wash water. These substances give off vapors that could ignite or explode.
- Under certain conditions, hydrogen gas may be produced in a hot water system that has not been used for 2 weeks or more. **HYDROGEN GAS IS EXPLOSIVE.** If the hot water system has not been used for such a period, before using the washing machine, turn on all hot water faucets and let the water flow from each for several minutes. This will release any accumulated hydrogen gas. As the gas is flammable, do not smoke or use an open flame during this time.
- Do not allow children to play on or in the washer. Close supervision of children is necessary when the washer is used near children.
- Before the washer is removed from service or discarded, remove the door or lid.
- Do not reach into the washer if the drum, tub or agitator is moving.
- Do not install or store the washer where it will be exposed to the weather.
- Do not tamper with controls.
- Do not repair or replace any part of the washer or attempt any servicing unless specifically recommended in this manual or in published user-repair instructions that you understand and have the skills to carry out.
- See “Electrical Requirements” for grounding instructions.

## SAVE THESE INSTRUCTIONS

## IMPORTANT SAFETY INSTRUCTIONS

- Keep the area underneath and around your appliances free of combustible materials such as lint, paper, rags, chemicals, etc.
  - Do not mix chlorine bleach with ammonia or acids such as vinegar and/or rust remover. Mixing different chemicals can produce a toxic gas which may cause death.
  - The laundry process can reduce the flame retardancy of fabrics. To avoid such a result, carefully follow the garment manufacturer's wash and care instructions.
  - To minimize the possibility of electric shock, unplug this appliance from the power supply or disconnect the washer at the household distribution panel by removing the fuse or switching off the circuit breaker before attempting any maintenance or cleaning.
- NOTE:** Pushing the OFF button does not disconnect the appliance from the power supply.
- Never attempt to operate this appliance if it is damaged, malfunctioning, partially disassembled, or has missing or broken parts, including a damaged cord or plug.
  - Use this appliance only for its intended purpose as described in this Owner's Manual.

# INSTALLATION REQUIREMENTS

## Tools and Parts

Gather the required tools and parts before starting installation. Read and follow the instructions provided with any tools listed here.

### Tools needed:

- Pliers that open to 1 $\frac{1}{16}$ " (3.95 cm)
- Flashlight (optional)
- Adjustable or open end wrench  $\frac{9}{16}$ " (14 mm)
- Level
- Wood block
- Utility knife
- Measuring tape

### Parts supplied:

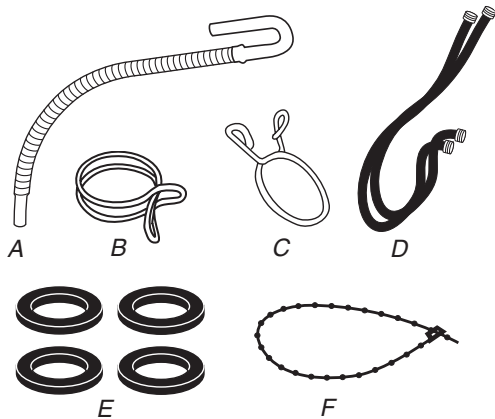

- A. Drain hose  
 B. Silver, double-wire hose clamp (for the bottom of the drain hose)  
 C. Yellow, single-wire hose clamp (for the top of the drain hose)  
 D. Water inlet hoses (2)  
 E. Flat water inlet hose washers (4)  
 F. Beaded tie strap

### Alternate Parts

Your installation may require additional parts. For ordering information, please refer to the "Consumer Service" section of this manual.

If You Have:	You Will Need to Buy:
Laundry tub or standpipe taller than 72" (183 cm)	Sump pump system (if not already available)
Overhead sewer	Standard 20 gal. (76 L) 39" (99 cm) tall drain tub or utility sink, sump pump and connectors (available from local plumbing suppliers)
Water faucets beyond reach of fill hoses	2 longer water fill hoses: 6 ft (1.8 m) Part Number WX14X89

## Location Requirements

Selecting the proper location for your washer improves performance and minimizes noise and possible washer "walk." Your washer can be installed in a basement, laundry room, closet, or recessed area. See "Drain System."

**IMPORTANT:** Do not install or store the washer where it will be exposed to the weather.

Proper installation is your responsibility.

### You will need:

- A water heater set to deliver 120°F (49°C) water to the washer.
- A grounded electrical outlet located within 5 ft (1.5 m) of where the power cord is attached to the back of the washer. See "Electrical Requirements."
- Hot and cold water faucets located within 3 $\frac{1}{2}$  ft (1.1 m) of the hot and cold water fill valves, and water pressure of 5-100 psi (34.5-690 kPa).
- A level floor with a maximum slope of  $\frac{3}{4}$ " (1.9 cm) under entire washer. Installing the washer on carpeting is not recommended.
- A sturdy floor to support the washer weight (washer, water and load) of 260 lbs (118 kg).

Do not store or operate your washer in temperatures at or below 32°F (0°C). Some water can remain in the washer and can cause damage in low temperatures. See "Washer Care" for winterizing information.

### Recessed area or closet installation

The dimensions shown are for the recommended spacing allowed, except the closet door ventilation openings. The dimensions shown for the closet door ventilation openings are the minimum required.

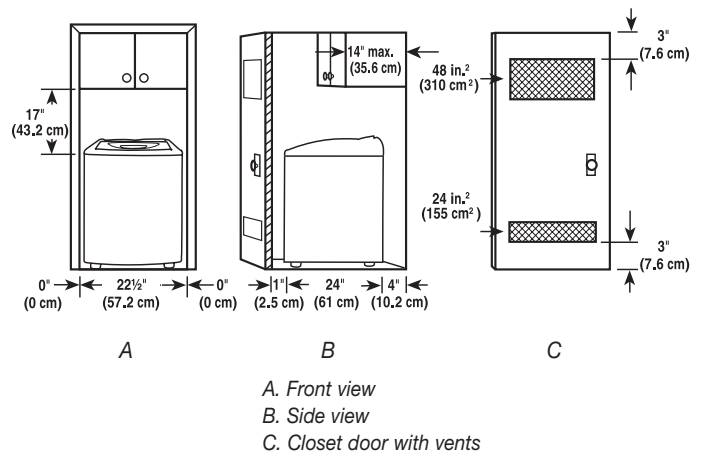

- Additional spacing should be considered for ease of installation and servicing.
- Additional clearances may be required for wall, door and floor moldings.
- Additional spacing of 1" (2.5 cm) on all sides of the washer is recommended to reduce noise transfer.
- If a closet door is installed, the minimum air openings in the top and bottom of the door are required. Louvered doors with air openings in the top and bottom are acceptable.
- Companion appliance spacing should also be considered.

## Electrical Requirements

### **⚠ WARNING**



#### **Electrical Shock Hazard**

**Plug into a grounded 3 prong outlet.**

**Do not remove ground prong.**

**Do not use an adapter.**

**Do not use an extension cord.**

**Failure to follow these instructions can result in death, fire, or electrical shock.**

- A 120-volt, 60-Hz, AC-only, 15- or 20-amp, fused electrical supply is required. A time-delay fuse or circuit breaker is recommended. It is recommended that a separate circuit serving only this appliance be provided.
- This washer is equipped with a power supply cord having a 3 prong grounding plug.
- To minimize possible shock hazard, the cord must be plugged into a mating, 3 prong, grounding-type outlet, grounded in accordance with local codes and ordinances. If a mating outlet is not available, it is the personal responsibility and obligation of the customer to have the properly grounded outlet installed by a qualified electrician.
- If codes permit and a separate ground wire is used, it is recommended that a qualified electrician determine that the ground path is adequate.

- Do not ground to a gas pipe.
- Check with a qualified electrician if you are not sure the washer is properly grounded.
- Do not have a fuse in the neutral or ground circuit.

### **GROUNDING INSTRUCTIONS**

#### **For a grounded, cord-connected washer:**

This washer must be grounded. In the event of a malfunction or breakdown, grounding will reduce the risk of electrical shock by providing a path of least resistance for electric current. This washer is equipped with a cord having an equipment-grounding conductor and a grounding plug. The plug must be plugged into an appropriate outlet that is properly installed and grounded in accordance with all local codes and ordinances.

**WARNING:** Improper connection of the equipment-grounding conductor can result in a risk of electric shock. Check with a qualified electrician or serviceman if you are in doubt as to whether the appliance is properly grounded.

Do not modify the plug provided with the appliance – if it will not fit the outlet, have a proper outlet installed by a qualified electrician.

#### **For a permanently connected washer:**

This washer must be connected to a grounded metal, permanent wiring system, or an equipment grounding conductor must be run with the circuit conductors and connected to the equipment-grounding terminal or lead on the appliance.

## Remove Shipping Material

Before you install your washer, remove all shipping material.

### **! WARNING**

#### **Excessive Weight Hazard**

**Use two or more people to move and install washer.  
Failure to do so can result in back or other injury.**

1. To protect the floor, place two corner posts from the shipping material on the floor in back of the washer.
2. Firmly grasp the body of the washer and gently lay it on the corner posts.

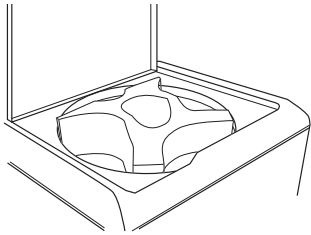

3. Remove plastic foam packaging from under washer. Use an adjustable wrench to turn the washer legs out approximately  $\frac{3}{4}$ " (1.9 cm). This is the recommended setting. Later adjustment may be needed.

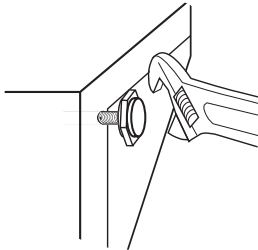

4. Stand the washer up.
5. Remove tape from washer lid. Open washer lid and remove foam shipping piece, parts bag and hoses from washer basket. Remove tags from dispenser drawer. Close the lid.

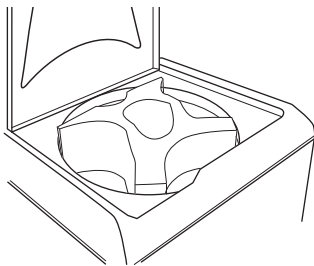

# INSTALLATION INSTRUCTIONS

## Before You Start

### **! WARNING**

#### Excessive Weight Hazard

**Use two or more people to move and install washer.  
Failure to do so can result in back or other injury.**

- To prevent floor damage, set the washer onto cardboard before moving across floor.
- Move the washer to within approximately 3 ft (90 cm) of the final location.

## Drain System

The washer can be installed using the standpipe drain system (floor or wall), or the laundry tub drain system.

Select the drain hose installation method you need. See "Tools and Parts."

### Standpipe drain system - wall or floor (views A & B)

The standpipe drain requires a minimum diameter standpipe of 2" (5 cm). The minimum carry-away capacity can be no less than 13 gal. (49.2 L) per minute.

The top of the standpipe must be at least 39" (99 cm) high and no higher than 72" (183 cm) from the bottom of the washer.

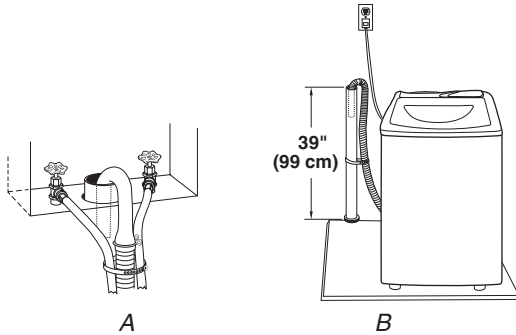

### Laundry tub drain system (view C)

The laundry tub requires a minimum carry-away capacity of 13 gal. (49.2 L) per minute.

The top of the laundry tub must be at least 39" (99 cm) above the floor and no higher than 72" (183 cm) from the bottom of the washer.

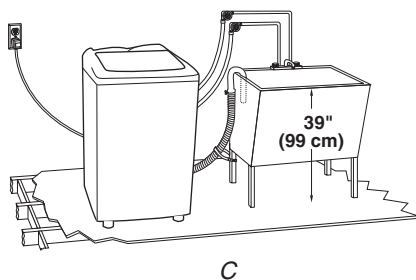

## Connect Drain Hose

Proper connection of the drain hose will protect your floors from damage due to water leakage. To prevent the drain hose from coming off or leaking, it must be installed according to the following instructions.

**IMPORTANT:** To ensure proper installation, this procedure must be followed exactly.

1. Check the drain hose to see that it is the proper length.
2. Wet the inside of the straight end of the drain hose with tap water.

**IMPORTANT:** Do not use any lubricant other than water.

3. Squeeze ears of double-wire clamp with pliers to open. Place clamp over the straight end of the drain hose  $\frac{1}{4}$ " (6 mm) from the end. Twist hose back and forth while pushing down onto drain connector at the bottom of the washer. Continue until hose contacts the cabinet.

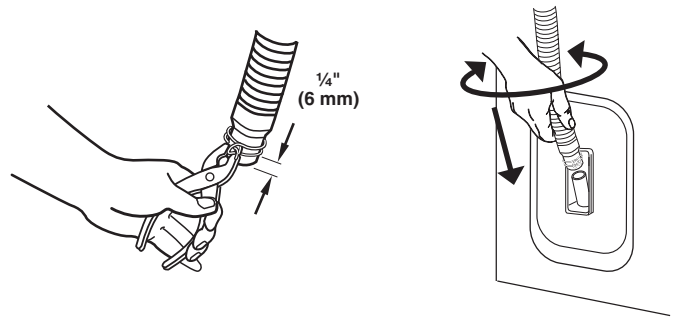

4. Place clamp over area marked "CLAMP." Release clamp.

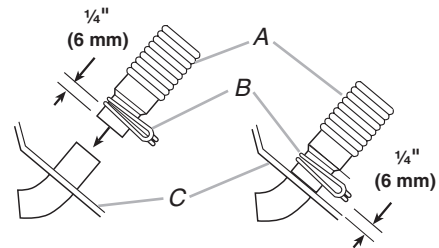

A. Drain hose  
B. Clamp  
C. Cabinet

### For standpipe or laundry tub drain systems:

1. Open yellow, single-wire clamp with pliers and slide over hooked end of drain hose to secure the rubber and corrugated sections together.

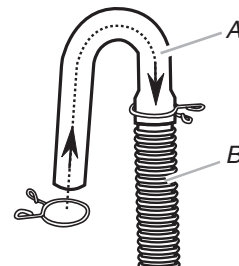

A. Hooked end  
B. Drain hose

- Put hooked end of drain hose into laundry tub or standpipe. Rotate hook to eliminate kinks in the hose.

**To prevent drain water from going back into the washer:**

- Do not straighten hooked end of drain hose. Do not force excess drain hose into standpipe. Hose should be secure, but loose enough to provide a gap of air.
- Do not lay excess drain hose in bottom of laundry tub.

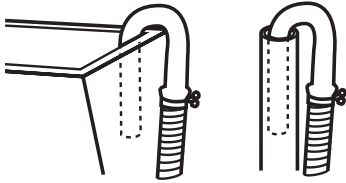

- For floor drain installation, see kit number required under "Tools and Parts."

## Connect the Inlet Hoses

- Insert new flat washers (supplied) into each end of the inlet hoses. Firmly seat the washers in the couplings.



A. Coupling  
B. Washer

### Connect the inlet hoses to the water faucets

Make sure the washer basket is empty.

- Attach the hose with the red coupling to the hot water faucet. Screw on coupling by hand until seated on the washer.
- Attach the hose with the blue coupling to the cold water faucet. Screw on coupling by hand until seated on the washer.
- Using pliers, tighten the couplings with an additional two-thirds turn.

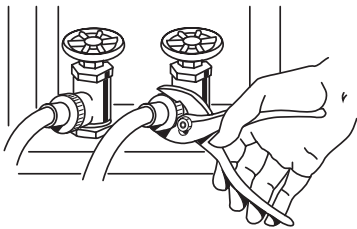

**NOTE:** Do not overtighten. Damage to the valves can result.

### Clear the water lines

- Run water through both faucets and inlet hoses, into a bucket or laundry tub, to get rid of particles in the water lines that might clog the inlet valve screens.

### Connect the inlet hoses to the washer

- Attach the hose with the red coupling to the HOT (right) inlet valve. Attaching the red coupling first makes it easier to tighten connection with pliers. Screw on coupling by hand until it is seated on the washer. Using pliers, tighten the couplings with an additional two-thirds turn.

**NOTE:** Do not overtighten. Damage to the valves can result.

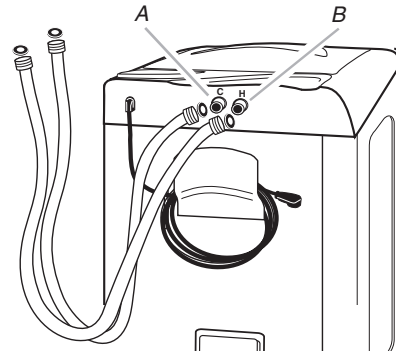

A. Cold water inlet valve (blue)  
B. Hot water inlet valve (red)

- Attach the hose with the blue coupling to the COLD water (left) inlet valve. Screw on coupling by hand until it is seated on the washer. Using pliers, tighten the couplings with an additional two-thirds turn.

**NOTE:** Do not overtighten. Damage to the valves can result.

### Check for leaks

- Turn on the water faucets and check for leaks. A small amount of water might enter the washer. You will drain this later.

**NOTE:** Replace inlet hoses after 5 years of use to reduce the risk of hose failure. Record hose installation or replacement dates for future reference.

- If you connect only one water hose, you must cap off the remaining water inlet port.
- Periodically inspect and replace hoses if bulges, kinks, cuts, wear, or leaks are found.



## Secure Drain Hose

1. Drape the power cord over the console.
2. Move the washer to its final location and remove any cardboard used to move washer.
3. Locate the beaded tie strap (supplied).



Beaded Tie Strap

4. Wrap the drain hose to the laundry tub leg or standpipe with the tie strap. (See illustrations A and B.)

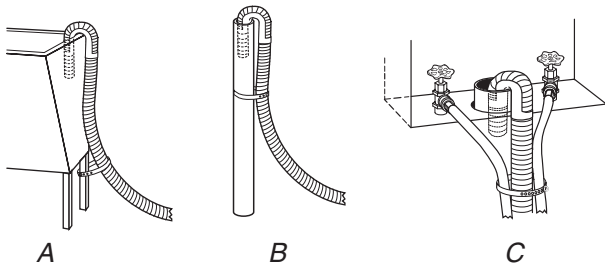

If the washer faucets and the drain standpipe are recessed, put the hooked end of the drain hose in the standpipe. (See illustration C.) Tightly wrap the tie strap around the water inlet hoses and the drain hose.

Do not force excess drain hose back into the rear of the washer.

## Level the Washer

Properly leveling your washer prevents excessive noise and vibration.

1. Move washer to final location.
2. Check that the washer is level.
  - Check side to side and front to back by lining up the level as shown in the following illustration.

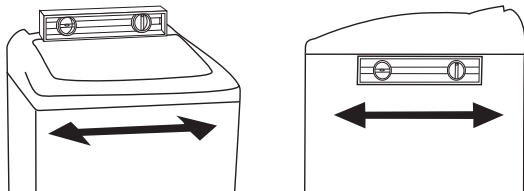

3. If the washer is not level, prop up the front of the washer with the wood block and adjust the feet up or down as necessary. If the washer is against a wall, move the washer out slightly before tipping back. Repeat this step until washer is level.

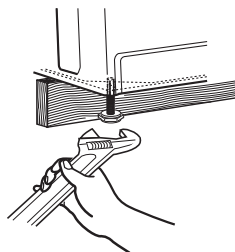

## Complete Installation

1. Check the electrical requirements. Be sure that you have the correct electrical supply and the recommended grounding method. See "Electrical Requirements."
2. Check to be sure all parts are now installed. If there is an extra part, go back through the steps to see which step was skipped.
3. Check to be sure you have all of your tools.
4. Dispose of/recycle all packaging materials. Keep the expanded foam plug for use if the washer should be transported.
5. Check to be sure the water faucets are on.
6. Check for leaks around faucets and inlet hoses.

### ⚠ WARNING



#### Electrical Shock Hazard

**Plug into a grounded 3 prong outlet.**

**Do not remove ground prong.**

**Do not use an adapter.**

**Do not use an extension cord.**

**Failure to follow these instructions can result in death, fire, or electrical shock.**

7. Plug into a grounded 3 prong outlet.
8. Read "Washer Use."
9. To test your washer, measure and add  $\frac{1}{2}$  the normal recommended amount of detergent to the washer. Close the lid. Select any cycle, and then press START/OFF. Allow it to complete one whole cycle.



# WASHER USE

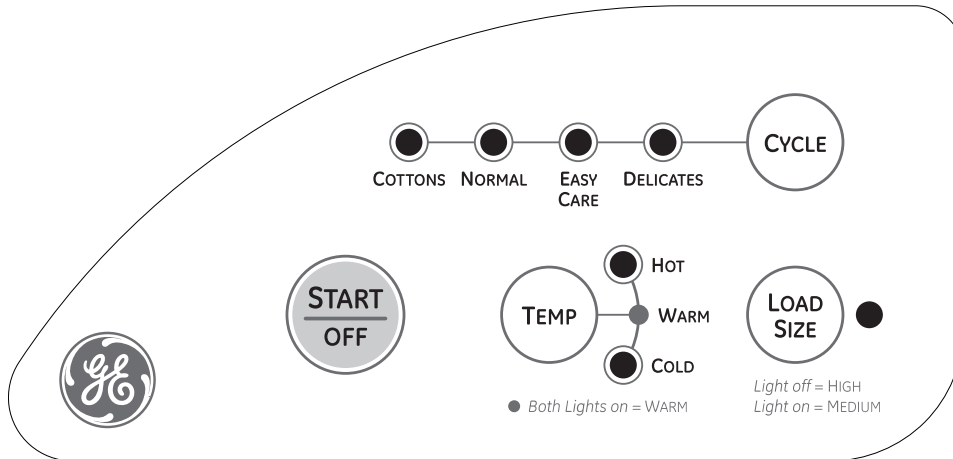

## Starting Your Washer

### ⚠ WARNING



#### Fire Hazard

Never place items in the washer that are dampened with gasoline or other flammable fluids.

No washer can completely remove oil.

Do not dry anything that has ever had any type of oil on it (including cooking oils).

Doing so can result in death, explosion, or fire.

**WARNING:** To reduce the risk of fire, electric shock, or injury to persons, read the IMPORTANT SAFETY INSTRUCTIONS before operating this appliance.

The following is a guide to starting your washer. Periodic references to other sections of this manual provide more detailed information.

1. Add measured detergent. Add liquid detergent to the bottom of the washer or powdered detergent to the detergent dispenser drawer.

**NOTE:** If desired, powdered color-safe bleach can be added to the detergent dispenser with the powdered detergent. Liquid color-safe bleach should be added to the bottom of the washer basket.

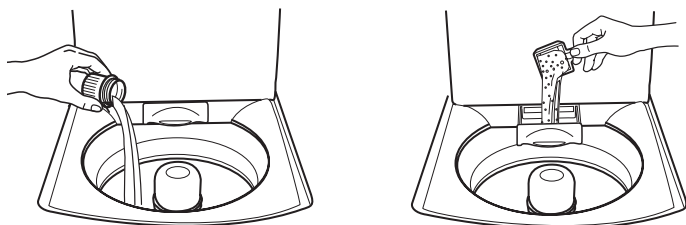

Drop a sorted load of clothes loosely into your washer.

- Load evenly to maintain washer balance. Mix large and small items.
- Items should move easily through the wash water. Overloading can cause poor cleaning.
- To reduce wrinkling of permanent press clothes and some synthetic knits, use the large load water level setting to provide more space (see Step 5).

2. (OPTIONAL STEP) Pour measured liquid chlorine bleach into the liquid chlorine bleach dispenser. Bleach will be dispensed automatically during the wash part of the cycle.

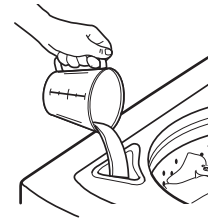

- Do not use more than 1 cup (250 mL) for a full load. Use less for a smaller load size.
- Follow the manufacturer's directions for proper use.
- To avoid spilling, use a cup with a pouring spout. Do not let bleach splash, drip, or run down into the washer basket.
- Use only liquid chlorine bleach in this dispenser.

- (OPTIONAL STEP) Pour measured liquid fabric softener into the liquid fabric softener dispenser. Softener is added automatically during the rinse portion of the cycle.

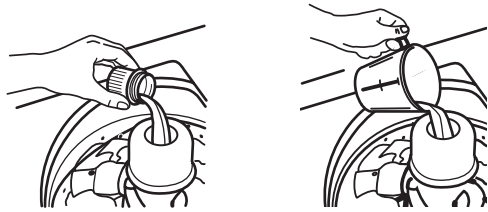

Dilute liquid fabric softener by filling the dispenser with warm water until liquid reaches the top line marked inside the dispenser.

- Do not spill or drip any fabric softener on the clothes.
- Use only liquid fabric softener in this dispenser.

**NOTE:** Do not wash clothes with the fabric softener dispenser removed.

- Close the washer lid. Washer will not fill, agitate or spin with the lid open.
- Press the WATER LEVEL button to select the correct setting for your wash load and the type of fabric being washed. For a medium load the indicator light is on, for a large load the light is off.
  - Choose a water level that allows the load to move freely for best fabric care. See “Loading.”
  - You may change the water level setting while the washer is filling. If you change from high to medium but the water has filled past medium, you will get medium with the next fill.
- Set the water temperature for the type of fabric and soils being washed. Use the warmest wash water safe for fabric. Follow garment label instructions.

Press the WASH/RINSE TEMPERATURE button to set the wash temperature. For a Hot wash the top light is on, for Cold the bottom light is on, for Warm both lights are on. All cycles use a cold rinse.

### Selecting Water Temperatures

Water Temp	Use for
Hot	Whites and pastels Heavy soils
Warm	Bright colors Moderate to light soils
Cold	Colors that bleed or fade Light soils

**NOTE:** In wash water temperatures colder than 70°F (21°C), detergents do not dissolve well. Soils can be difficult to remove. Some fabrics can retain wear wrinkles and have increased pilling (the formation of small lint-like balls on the surface of garments).

- Press the CYCLE SELECTOR button to select the wash cycle you want. See “Cycles.”
- Press START/OFF.

### To stop or restart your washer

- To stop the washer at any time, lift the lid, cycle will pause.
- To restart the washer, close the lid, cycle will resume.

## Cycles

This section describes the available wash cycles and will help you make the best cycle selections for your wash loads. Each cycle is designed for different types of fabric and soil levels.

- The washer pauses briefly throughout each cycle. These pauses are normal. Refer to “Normal Sounds” to learn more about the sounds you may hear during a wash cycle.
- Refer to “Understanding Washer Cycles” to learn what happens during a wash cycle.

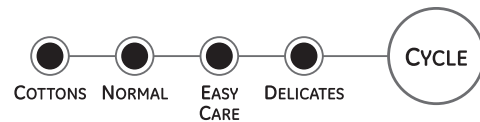

### Cottons

Use this cycle to get 18 minutes of wash time for sturdy or heavily soiled loads. Wash combines high-speed agitation and high-speed spin for maximum soil removal.

### Normal

Use this cycle to get 12 minutes of wash time for normally soiled cottons and linens. Wash combines medium-speed agitation and high-speed spin to shorten drying time.

### Easy Care

Use this cycle to get 10 minutes of wash time. Use for wrinkle-free and permanent press items, and knits. Wash combines medium-speed agitation and high-speed spin to shorten drying time.

### Delicates

Use this cycle to get 6 minutes of wash time for lingerie and loosely knit items. Wash combines low-speed agitation for gentle soil removal, and high-speed spin to shorten drying time.

## Understanding Washer Cycles

When a cycle is selected, the washer lid is closed, and START/OFF is pushed, the washer fills (to the selected load size) before agitation and timing start. The lid must be closed during operation. The washer will not fill, agitate or spin with the lid open.

**NOTE:** The washer pauses briefly throughout each cycle. These pauses are normal for washer operation.

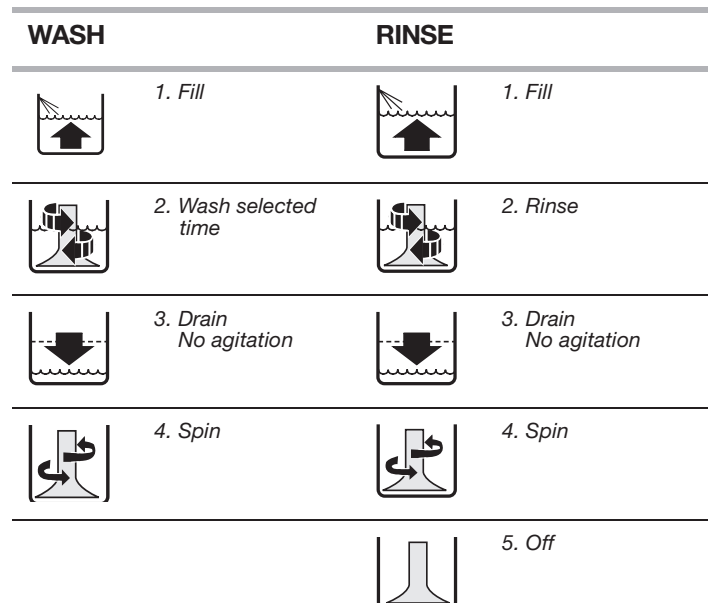

---

## Normal Sounds

Your new washer may make sounds your old one didn't. Because the sounds might be unfamiliar, you may be concerned about them. These sounds are normal.

### During drain

If water is drained quickly from your washer (depending on your installation), you may hear air being pulled through the pump during the end of draining.

### After drain and before spin

When the cycle changes from draining to spinning, you may hear gears engaging.

---

## LAUNDRY TIPS

### Preparing clothes for washing

Follow these recommendations to help you prolong the life of your garments.

- Close zippers, snaps, and hooks to avoid snagging other items. Remove pins, buckles, and other hard objects to avoid scratching the washer interior. Remove non-washable trim and ornaments.
- Empty pockets and turn them inside-out.
- Turn down cuffs; brush away lint and dirt.
- Turn synthetic knits inside-out to avoid pilling.
- Tie strings and sashes so they will not tangle.
- Mend tears, loose hems, and seams.
- Treat spots and stains.
- Stained or wet garments should be washed promptly for best results.

### Sorting

- Separate heavily soiled items from lightly soiled ones, even if they would normally be washed together. Separate lint-givers (towels, chenille) from lint-takers (corduroy, synthetics, permanent press). When possible, turn lint-givers inside-out.
- Separate dark colors from light colors, colorfast items from noncolorfast items.
- Sort by fabric and construction (sturdy cottons, knits, delicate items).

### Unloading

- Remove clothes from washer after the cycle is completed. Metal objects such as zippers, snaps, and buckles may rust if left in the washer basket for a long time.

---

## Loading

### Loading suggestions

For these suggested full-sized loads, set the WATER LEVEL selector to the highest setting.

---

### COMPACT WASHERS

---

#### Heavy Work Clothes

2 pair pants  
3 work shirts

#### Knit

2 slacks  
2 shirts  
-or-  
3 dresses

---

#### Towels

9 bath towels  
-or-  
6 bath towels  
3 hand towels  
6 washcloths

#### Mixed Load

1 pair slacks  
2 pillowcases  
2 shirts  
1 T-shirt

---

#### Permanent Press

6 shirts  
-or-  
2 double sheets  
2 pillowcases  
-or-  
2 single sheets  
2 pillowcases

#### Delicates

1 camisole  
2 slips  
2 panties  
2 bras  
1 nightie  
1 half-slip

---

---

# WASHER CARE

---

## Cleaning Your Washer

### Cleaning the exterior

Use a soft, damp cloth or sponge to wipe up any spills such as detergent or bleach. Occasionally wipe the outside of your washer to keep it looking new.

### Cleaning the interior

Add 1 cup (250 mL) of chlorine bleach and 1 scoop or capful of detergent to the washer, and run it through a normal cycle using hot water. Repeat this process if necessary.

**NOTE:** Remove any hard water deposits using only cleaners labeled as washer safe.

### Cleaning the lint filter:

Clean filter after every load.

1. Grasp the top of the fabric softener dispenser and pull straight upward to remove. The lint filter is attached to the end of the shaft.
2. Wash or wipe the lint filter clean.
3. Push fabric softener dispenser and lint filter firmly back into agitator.

### Cleaning the liquid fabric softener dispenser:

Flush fabric softener dispenser periodically with warm water.

1. Grasp the top of the dispenser and pull upward to remove.
2. Flush the dispenser with warm water. Replace after cleaning.

**NOTE:** To avoid damage to the washer or clothing, do not wash clothes with the fabric softener dispenser removed. Do not add detergent or bleach to this dispenser; it is for liquid fabric softener only.

---

## Water Inlet Hoses

Replace inlet hoses after five years of use to reduce the risk of hose failure. Periodically inspect and replace inlet hoses if bulges, kinks, cuts, wear or leaks are found.

When replacing your inlet hoses, mark the date of replacement on the label with a permanent marker.

## Vacation, Storage, and Moving Care

Install and store your washer where it will not freeze. Because some water may stay in the hoses, freezing can damage your washer. If storing or moving your washer during freezing weather, winterize it.

### Non-use or vacation care:

Operate your washer only when you are at home. If you will be on vacation or not using your washer for an extended period of time, you should:

- Unplug washer or disconnect power.
- Turn off the water supply to the washer. This helps avoid accidental flooding (due to a water pressure surge) while you are away.

### To winterize washer:

1. Shut off both water faucets.
2. Disconnect and drain water inlet hoses.
3. Put 1 qt (1 L) of R.V.-type antifreeze in the basket.
4. Unplug washer or disconnect power.

### To use washer again:

1. Flush water pipes and hoses.
2. Reconnect water inlet hoses.
3. Turn on both water faucets.
4. Plug in washer or reconnect power.
5. Run the washer through any cycle with ½ the normal recommended amount of detergent to clean out the antifreeze.

### To transport the washer:

1. Shut off both water faucets.
2. Disconnect and drain water inlet hoses.
3. If washer will be moved during freezing weather, put in 1 qt (1 L) of R.V.-type antifreeze in the basket.
4. Disconnect the drain from the drain system.
5. Unplug the power cord.
6. Place the inlet hoses into the basket.
7. Drape the power cord and drain hose over edge into the basket.

### Reinstalling the washer

1. Follow the installation instructions for your model to locate, level and connect the washer.
2. Run the washer through any cycle with ½ the normal recommended amount of detergent to clean out the antifreeze, if used.

---

# TROUBLESHOOTING

First try the solutions suggested here and possibly avoid the cost of a service call...

---

## Washer won't fill, rinse or wash

---

- **Is the lid open?**  
The lid must be closed during operation. The washer will not fill, agitate or spin with the lid open.
- **Does the water level seem too low, or does the washer appear to not fill completely?**  
The top of the agitator is much higher than the highest water level. This creates a perception that the washer is not filling completely. This is normal.
- **Check the following:**  
Is the power cord plugged into a grounded 3 prong outlet?  
Is there power at the plug? Check electrical source or call electrician.  
Are the hot and cold water faucets turned on?  
Is the water inlet hose kinked?  
Are the water inlet valve screens clogged?

---

## Washer stops

---

- **Check the following:**  
Is the power cord plugged into a grounded 3 prong outlet?  
Are the hot and cold water faucets turned on?  
Is the water inlet hose kinked?  
Are the water inlet valve screens clogged?
- **Is there power at the plug?**  
Check electrical source or call electrician.
- **Has a fuse blown, or has the circuit breaker tripped?**  
If problem continues, call electrician.
- **Are you using an extension cord?**  
Do not use an extension cord.
- **Is the washer overloaded?**  
Wash smaller loads. See "Starting Your Washer" for maximum load size.
- **Is the lid open?**  
The lid must be closed during operation. The washer will not fill, agitate or spin with the lid open.

---

## Washer won't drain or spin

---

- **Is the drain hose clogged, or the end of the drain hose more than 72" (183 cm) above floor (48" [122 cm] for portable washers)?**  
Refer to the installation instructions for your model for proper installation of drain hose.
- **Is the lid open?**  
The lid must be closed during operation. The washer will not fill, agitate or spin with the lid open.
- **Is there excessive sudsing?**  
Always measure detergent. Follow manufacturer's directions. If you have very soft water, you may need to use less detergent.
- **Is your voltage low?**  
Check electrical source or call electrician. Do not use an extension cord.

---

## Washer continues to fill or drain, or the cycle seems stuck

---

- **Does the drain hose fit too tightly in the standpipe, or is it taped to the standpipe?**  
The drain hose should be loose yet fit securely. Do not seal the drain hose with tape. The hose needs an air gap. See "Installation Instructions."
- **Is the end of the drain hose less than 39" (99 cm) above the floor?**  
Refer to the installation instructions for your model for proper installation of drain hose.

---

## Washer makes noise

---

- **Is the load balanced and the washer level?**  
The wash load should be balanced. See "Starting Your Washer" for maximum load size.  
The washer must be level. Refer to the installation instructions for your model.  
Can you hear water spraying? This is part of the wash action. If water is drained quickly from the washer, you may hear air being pulled through the pump. This happens during the end of draining. It is normal.  
When the cycle changes from washing to draining or spinning, you may hear a noise as the drive system shifts. This is normal.
- **Are you washing items with metal snaps, buckles or zippers?**  
You may hear metal items touching the basket. This is normal.
- **Are you washing a small load?**  
You will hear more splashing sounds when washing small loads. This is normal.
- **Is the washer installed on a solid floor?**  
Refer to your installation instructions for flooring requirements.

---

## Washer leaks

---

- **Check the following:**  
Are the fill hoses tight? Are the fill hose washers properly seated? Is the drain hose clamp properly installed? Refer to the installation instructions for your model.
- **Is the sink or drain clogged?**  
Sink, floor drain and standpipe must be able to handle 13 gal. (49.2 L) of water per minute.
- **Is water bouncing off the tub ring or the load?**  
The wash load should be balanced and not overloaded. If not, the fill or spray rinses can bounce off the load.  
The washer must be level. Refer to the installation instructions for your model.
- **Did you install the drain hose in a standpipe or laundry tub?**  
See "Installation Instructions."
- **Check household plumbing for leaks.**

---

## Washer basket is crooked

---

- **Was the washer basket pulled forward during loading?**  
Push the basket to the center before starting wash.
- **Is the load balanced and the washer level?**  
The wash load should be balanced.  
The washer must be level. Refer to the installation instructions for your model.
- **The washer basket moves while washing.**  
This is normal.

---

## Dispensers clogged or leaking

---

- **Are the laundry products in the correct dispenser?**  
Add the correct amounts of powdered detergent, liquid chlorine bleach, or fabric softener to the correct dispenser. You can add powdered color-safe bleach to the detergent dispenser. Liquid detergent should be added to the bottom of the washer basket.  
Be sure to match powdered color-safe bleach with powdered detergent or match liquid color-safe bleach with liquid detergent. Use only liquid chlorine bleach in the bleach dispenser.

---

## Load too wet

---

- **Cold rinses leave loads wetter than warm rinses.**  
This is normal.

---

## Residue or lint on load

---

- **Did you add powdered detergent to the dispenser?**  
For best results, use the dispenser to dissolve powdered detergent. Add liquid detergent directly to the bottom of the washer basket.
- **Did you sort properly?**  
Sort lint givers (towels, chenille) from lint takers (corduroy, synthetics). Also sort by color.
- **Did you overload the washer?**  
The wash load must be balanced. See “Starting Your Washer” for maximum load size. Lint can be trapped in the load if overloaded. Wash smaller loads.
- **Was paper or tissue left in pockets?**
- **Did you use enough detergent?**  
Follow manufacturer’s directions. Use enough detergent to hold the lint in the water.
- **Is your water colder than 70°F (21°C)?**  
Wash water colder than 70°F (21°C) may not completely dissolve the detergent.
- **Are you using a gentle wash cycle?**  
Consider using liquid detergent for slow-speed cycles such as Gentle or Delicate.

---

## Stains on load

---

- **Did you add powdered detergent to the dispenser?**  
For best results, use the dispenser to dissolve powdered detergent. Add liquid detergent directly to the bottom of the washer basket.
- **Did you use enough detergent?**  
Use enough detergent to remove soil and hold it in suspension. Add the manufacturer’s recommended amounts.
- **Did you add fabric softener directly to the load?**  
Use your fabric softener dispenser. Do not drip fabric softener on clothes.
- **Is there above average iron (rust) in water?**  
You may need to install an iron filter.
- **Did you properly sort the load?**  
Sort dark clothes from whites and lights.
- **Did you unload the washer promptly?**  
To avoid dye transfer, unload the washer as soon as it stops.
- **Did you use powder detergent in a low-speed cycle?**  
Consider using liquid detergent.
- **Did you add detergent, chlorine bleach or fabric softener too late in the cycle?**  
Powdered detergent, chlorine bleach, and fabric softener should be added to the dispensers before starting the washer. Add liquid detergent directly to the bottom of the washer basket.

---

## Load is wrinkled

---

- **Did you unload the washer promptly?**  
Unload the washer as soon as it stops.
- **Did you overload the washer?**  
The wash load must be balanced and not overloaded. Loads should move freely during washing.
- **Are the hot and cold water hoses reversed?**  
Check to be sure the hot and cold water hoses are connected to the right faucets. See “Installation Instructions.”

---

## Load is tangled or twisted

---

- **Did you overload the washer?**  
See “Starting Your Washer” for maximum load size. Loads should move freely during washing.

---

## Gray whites, dingy colors

---

- **Did you properly sort the load?**  
Dye transfer can occur when mixing whites and colors in a load. Sort dark fabrics from whites and lights.
- **Was the wash temperature too low?**  
Use hot or warm washes if safe for the load. Make sure your hot water system is adequate to provide a hot water wash.
- **Did you use enough detergent, or do you have hard water?**  
Use more detergent for washing heavy soils in cold or hard water. Water temperature should be at least 70°F (21°C) for detergent to dissolve and work properly.



---

## Garment damage

---

■ **Check the following:**

Were sharp items removed from pockets before washing?  
Empty pockets, zip zippers, snap or hook fasteners before washing.

Were strings and sashes tied to prevent tangling?

Were items damaged before washing?

Mend rips and broken threads in seams before washing.

■ **Did you overload the washer?**

See “Loading” for maximum load size.

■ **Did you properly add chlorine bleach?**

Do not pour chlorine bleach directly on load. Use your liquid chlorine bleach dispenser. Wipe up bleach spills. Undiluted bleach will damage fabrics. Do not place load items on top of the bleach dispenser when loading and unloading the washer.

■ **Did you follow the manufacturer's care label instructions?**

---

## Wash temperature is not what I selected

---

■ **Are the hot and cold water inlet hoses reversed?**

As washing progresses, the wash temperature will decrease slightly for hot and warm washes. This is normal.



## NOTES

## GE Service Protection Plus™

GE, a name recognized worldwide for quality and dependability, offers you Service Protection Plus™—comprehensive protection on all your appliances—**No Matter What Brand!**

**Benefits Include:**

- Backed by GE
- All brands covered
- Unlimited service calls
- All parts and labor costs included
- No out-of-pocket expenses
- No hidden deductibles
- One 800 number to call

***We'll Cover Any Appliance.  
Anywhere. Anytime.\****

You will be completely satisfied with our service protection or you may request your money back on the remaining value of your contract. No questions asked. It's that simple.

Protect your refrigerator, dishwasher, washer and dryer, range, TV, VCR and much more—**any brand!** Plus there's no extra charge for emergency service and low monthly financing is available. Even icemaker coverage and food spoilage protection is offered. You can rest easy, knowing that all your valuable household products are protected against expensive repairs.

Place your confidence in GE and call us in the U.S. toll-free at **800.626.2224** for more information.

\*All brands covered, up to 20 years old, in the continental U.S.



Please place in envelope and mail to:

***General Electric Company***  
**Warranty Registration Department**  
**P.O. Box 32150**  
**Louisville, KY 40232-2150**

# Consumer Product Ownership Registration

Dear Customer:

Thank you for purchasing our product and thank you for placing your confidence in us.

We are proud to have you as a customer!

**Follow these three steps to protect your new appliance investment:**

**1** Complete and mail your Consumer Product Ownership Registration today. Have the peace of mind of knowing we can contact you in the unlikely event of a safety modification.

**2** After mailing the registration below, store this document in a safe place. It contains information you will need should you require service. Our service number is 800.GE.CARES (800.432.2737).

**3** Read your Owner's Manual carefully. It will help you operate your new appliance properly.

Model Number

Serial Number

\_\_\_\_\_

\_\_\_\_\_

**Important: If you did not get a registration card with your product, detach and return the form below to ensure that your product is registered, or register online at [www.GEAppliances.com](http://www.GEAppliances.com).**



## Consumer Product Ownership Registration



Model Number

Serial Number

\_\_\_\_\_

\_\_\_\_\_

Mr.  Ms.  Mrs.  Miss

First Name \_\_\_\_\_

Last Name \_\_\_\_\_

Street Address \_\_\_\_\_

Apt. # \_\_\_\_\_

E-mail Address \_\_\_\_\_

City \_\_\_\_\_

State \_\_\_\_\_

Zip Code \_\_\_\_\_

Date Placed In Use  
Month \_\_\_\_\_

Day \_\_\_\_\_

Year \_\_\_\_\_

Phone Number \_\_\_\_\_-\_\_\_\_\_-\_\_\_\_\_



**GE Appliances**

GE Consumer & Industrial  
Louisville, Kentucky  
[www.GEAppliances.com](http://www.GEAppliances.com)

\* Please provide your e-mail address to receive, via e-mail, discounts, special offers and other important communications from GE Appliances (GEA).

Check here if you do not want to receive communications from GEA's carefully selected partners.

**FAILURE TO COMPLETE AND RETURN THIS CARD DOES NOT DIMINISH YOUR WARRANTY RIGHTS.**

For information about GEA's privacy and data usage policy, go to [www.GEAppliances.com](http://www.GEAppliances.com) and click on "Privacy Policy" or call 800.626.2224.

# GE Washer Warranty.



All warranty service provided by our Factory Service Centers, or an authorized Customer Care<sup>®</sup> technician. To schedule service, on-line, 24 hours a day, contact us at [www.GEAppliances.com](http://www.GEAppliances.com), or call 800.GE.CARES.

Staple your receipt here.  
Proof of the original purchase date is needed to obtain service under the warranty.

<b>For The Period Of:</b>	<b>We Will Replace:</b>
<b>One Year</b> From the date of the original purchase	<b>Any part</b> of the washer which fails due to a defect in materials or workmanship. During this <b>full one-year warranty</b> , we will also provide, <b>free of charge</b> , all labor and related service to replace the defective part.
<b>Second through Fifth Year</b> From the date of the original purchase	<b>The transmission, suspension rod and spring assembly</b> if any of these parts should fail due to a defect in materials or workmanship. GE will also replace <b>the washer lid or cover</b> , if they should rust under operating conditions. During this <b>additional four-year limited warranty</b> , you will be responsible for any labor or related service costs.
<b>Second through Tenth Year</b> From the date of the original purchase	<b>The washer tub</b> , if it should fail due to a defect in materials or workmanship. During this <b>additional nine-year limited warranty</b> , you will be responsible for any labor or related service costs.
<b>Second through Twentieth Year</b> From the date of the original purchase	<b>The washer basket</b> , if it should fail due to a defect in materials or workmanship. During this <b>additional nineteen-year limited warranty</b> , you will be responsible for any labor or related service costs.

## What Is Not Covered:

- Service trips to your home to teach you how to use the product.
- Improper installation, delivery or maintenance.
- Failure of the product if it is abused, misused, or used for other than the intended purpose or used commercially.
- Damage caused after delivery.
- Replacement of house fuses or resetting of circuit breakers.
- Damage to the product caused by accident, fire, floods or acts of God.
- Incidental or consequential damage caused by possible defects with this appliance.

This warranty is extended to the original purchaser and any succeeding owner for products purchased for home use within the USA. In Alaska, the warranty excludes the cost of shipping or service calls to your home. Some states do not allow the exclusion or limitation of incidental or consequential damages. This warranty gives you specific legal rights, and you may also have other rights which vary from state to state. To know what your legal rights are, consult your local or state consumer affairs office or your state's Attorney General.

**Warrantor: General Electric Company, Louisville, KY 40225**

Safety Instructions

Operating Instructions

Installation Instructions

Troubleshooting Tips

Consumer Support

## Consumer Support.

---



### *GE Appliances Website*

[www.GEAppliances.com](http://www.GEAppliances.com)

Have a question or need assistance with your appliance? Try the GE Appliances Website 24 hours a day, any day of the year! For greater convenience and faster service, you can now download Owner's Manuals, order parts, catalogs, or even schedule service on-line. You can also "Ask Our Team of Experts™" your questions, and so much more...



### *Schedule Service*

[www.GEAppliances.com](http://www.GEAppliances.com)

Expert GE repair service is only one step away from your door. Get on-line and schedule your service at your convenience 24 hours any day of the year! Or call 800.GE.CARES (800.432.2737) during normal business hours.



### *Real Life Design Studio*

[www.GEAppliances.com](http://www.GEAppliances.com)

GE supports the Universal Design concept—products, services and environments that can be used by people of all ages, sizes and capabilities. We recognize the need to design for a wide range of physical and mental abilities and impairments. For details of GE's Universal Design applications, including kitchen design ideas for people with disabilities, check out our Website today. For the hearing impaired, please call 800.TDD.GEAC (800.833.4322).



### *Extended Warranties*

[www.GEAppliances.com](http://www.GEAppliances.com)

Purchase a GE extended warranty and learn about special discounts that are available while your warranty is still in effect. You can purchase it on-line anytime, or call 800.626.2224 during normal business hours. GE Consumer Home Services will still be there after your warranty expires.

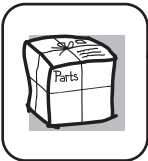

### *Parts and Accessories*

[www.GEAppliances.com](http://www.GEAppliances.com)

Individuals qualified to service their own appliances can have parts or accessories sent directly to their homes (VISA, MasterCard and Discover cards are accepted). Order on-line today, 24 hours every day or by phone at 800.626.2002 during normal business hours.



### *Contact Us*

[www.GEAppliances.com](http://www.GEAppliances.com)

If you are not satisfied with the service you receive from GE, contact us on our Website with all the details including your phone number, or write to: General Manager, Customer Relations  
GE Appliances, Appliance Park  
Louisville, KY 40225



### *Register Your Appliance*

[www.GEAppliances.com](http://www.GEAppliances.com)

**Register your new appliance on-line—at your convenience!** Timely product registration will allow for enhanced communication and prompt service under the terms of your warranty, should the need arise. You may also mail in the pre-printed registration card included in the packing material.