

M E R C E R  
C A S E G O O D S  
C O N F E R E N C E  
L I S T P R I C E S E F F E C T I V E  
M A R C H 1 , 2 0 0 8

M E R C E R



2 0 0 8

# HBF 2008 Price List Contents

Effective Date: March 1, 2008

**Mailing Address:**  
**HBF/HBF Textiles**  
PO Box 8  
Hickory, NC 28603-0008

**Shipping Address:**  
**HBF/HBF Textiles**  
900-12th Street Drive NW  
Hickory, NC 28601-4763

**Phone:** 828.328.2064  
**Fax:** 828.485.2690  
**info:** info@hbf.com  
www.hbf.com  
www.hbftextiles.com

## CONTENTS

	PAGE		PAGE
<b>CASEGOOD SPECIFICATIONS</b>		<b>CONFERENCE PRODUCTS</b>	
Access Panels, Removable . . . . .	.3	Conference Table Specifications - Metal Bases	
Base Details . . . . .	.3	Base Options . . . . .	.97
Edge Details . . . . .	.2	Edge Detail . . . . .	.97
Doors . . . . .	.3	Electrical Access Grommets . . . . .	.98
Drawers . . . . .	.3	Power/Data Plates . . . . .	.98
Finishes . . . . .	.2	Veneer . . . . .	.97
Grommets . . . . .	.4	Worksurfaces . . . . .	.97
Hardware . . . . .	.3	Conference Tables - Metal Bases . . . . .	.99
Levelers . . . . .	.3	Conference Table Specifications - Wood Bases	
Locks . . . . .	.3	Base Options . . . . .	.92
Modesty Panels . . . . .	.3	Base Placement . . . . .	.93
Pedestals . . . . .	.3	Edge Details . . . . .	.92
Suspension . . . . .	.3	Electrical Access Grommets . . . . .	.92
Veneer . . . . .	.2	Power/Data Plates . . . . .	.92
Worksurfaces . . . . .	.2	Veneer . . . . .	.92
<b>CASEGOODS</b>		Worksurfaces . . . . .	.92
Bookcases, Double High . . . . .	.85	Conference Tables - Wood Bases . . . . .	.94
Bookcases, Single High . . . . .	.84	Conference Cabinetry	
Bridges . . . . .	.35	Audio/Visual Cart, Mobile . . . . .	.107
Casegood Accessories		Audio/Visual Vertical Storage Cabinet . . . . .	.107
Pedestal Shelves . . . . .	.91	Lectern . . . . .	.109
Pedestal Dividers . . . . .	.91	Plasma Screen Enclosure . . . . .	.108
Stack Shelves . . . . .	.91	Wall Mounted Presentation Cabinet . . . . .	.107
Worksurface Shelves . . . . .	.91		
Corner Units . . . . .	.36		
Credenzas . . . . .	.20		
Credenza Storage Towers . . . . .	.41		
Desk Extensions . . . . .	.37		
Desks . . . . .	.5		
File Pedestal, Mobile . . . . .	.41		
Reception Desks . . . . .	.87		
Lateral Files . . . . .	.86		
Overhead Cabinets, Double High . . . . .	.48		
Overhead Cabinets, Single High . . . . .	.44		
Returns . . . . .	.31		
Table Desks . . . . .	.19		
Vertical Storage, Double High . . . . .	.80		
Vertical Storage, Single High . . . . .	.76		
Wardrobe Unit . . . . .	.77		

# HBF Mercer Casegood Specifications

All HBF casegood orders must be accompanied by suite layout drawings.  
 Drawings are needed to confirm proper unit configuration.  
 If drawings are not included, orders may be delayed to confirm specifications.

## Profile Edge Details

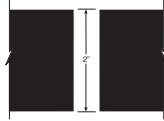

## Worksurfaces

Mercer components have a 2" (51mm) thick worksurface and premium grade veneer top faces, edges are bordered with veneer solids or edgebands.

## Veneer

The following slip matched, plain sliced veneers are available with the finish options as shown below. Pricing for these veneers are shown by veneer grade.

Anigre: Color and grain variations are typical characteristics of anigre veneer. Color may range from light yellow to pale brown, sometimes with a pink tint. The grain pattern of anigre will also vary in frequency and size; grain pattern changes should be expected within a given product or suite of furniture.

### Veneer Grade 1

Cherry  
 Maple  
 Ligno-Grain  
 Walnut

### Veneer Grade 2

Rift Oak  
 Sapele

### Veneer Grade 3

Anigre

## Finish Availability Chart

	Cherry	Veneer Grade 1 Maple	Ligno-Grain	Walnut	Veneer Grade 2 Rift Oak	Sapele	Veneer Grade 3 Anigre
01 Centennial	•		•				
02 Espresso	•		•				
03 Imperial	•		•				
05 Tuscan	•		•				
06 Amber	•		•			•	
07 Chestnut	•		•				
09 Onyx	•		•				
10 Honey	•		•				
11 Amazon	•		•				
12 Wheat		•	•				
16 Caramel		•	•		•		
17 Scone						•	
18 Biscotti		M*					
19 Butterscotch							•
20 Hazelnut		M*					
21 Chai							•
22 Cider		M*					
23 Mocha					•		
24 Chocolat		M*					
25 Cocoa				•			
26 Latte		M*					
27 Honeycomb				•			
28 Nectar		M*					
29 Nutmeg				•			
30 Toffee		M*					

**M\* (maple):** These finishes are available only on maple seating and occasional table products and allow the specifier to create a finish that is complementary to non-maple veneers available on conference and casegood products. HBF's maple seating and occasional table products can therefore be specified with HBF conference and casegoods constructed with the available non-maple veneers and create an office environment with complementary wood tones. These finishes are not available on conference or casegood products.

- 18 Biscotti on maple complements 17 Scone on sapele
- 20 Hazelnut on maple complements 19 Butterscotch on anigre
- 22 Cider on maple complements 21 Chai on anigre
- 24 Chocolat on maple complements 23 Mocha on rift oak
- 26 Latte on maple complements 25 Cocoa on walnut
- 28 Nectar on maple complements 27 Honeycomb on walnut
- 30 Toffee on maple complements 29 Nutmeg on walnut

All conference and casegood products are standard with a 30° sheen.

An upcharge of **10% Net** per unit for conference and casegood products, with a minimum upcharge of **\$375 Net** per order will apply for any custom wood finish.

# HBF Mercer Casegood Specifications

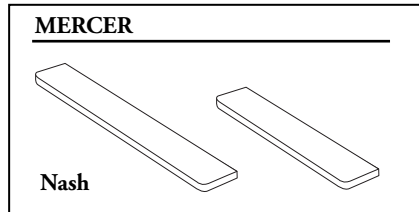
<b>Pedestals</b>	Three depths (24", 30" and 36")
<b>Doors</b>	Three (3) ply veneer mounted with universal adjustment concealed hinges.
<b>Levelers</b>	All floor casegoods have adjustable levelers.
<b>Modesty Panels</b>	Desk modesty panels are available as finished, fixed panels either recessed 4" or flushed. Credenza, return and bridge modesty panels are available as finished, fixed panels or as recessed, unfinished back removable access panels.
<b>Drawers</b>	<p>Box and file drawers are 1/2" wood, doweled to form a four (4) sided rectangle with separate drawer front.</p> <p>Drawer bottoms are 1/4" thick and fitted in a dado groove so it is captured on four sides.</p> <p>Drawer faces are mechanically attached to allow for easy alignment.</p> <p>Each desk equipped with a box/box/file pedestal will include one maple divider and one maple pencil tray.</p> <p>Center drawers are optional and include a cherry or maple pencil and paper clip tray, see HBF Casegood Accessories.</p> <p>Center drawers are standard on all Mercer table desks.</p>
<b>Suspension</b>	<p>All box drawers are standard with telescopic, full extension, ball-bearing slides.</p> <p>All file drawers are standard with fully progressive, full extension, ball-bearing slides.</p>
<b>Base Details</b>	Mercer casegoods offer a clean front with no base detail.
<b>Removable Access Panels</b>	<p>Mercer credenzas or returns without a finished back can be specified with removable access panels in the kneespace. This panel can be easily removed to allow for complete wall access. When installed, the top of the access panel will be 3 1/4" from the underside of the worksurface to allow for wire or cable egress. The back of this panel and the back of pedestals are unfinished.</p> <p>Mercer credenzas or returns specified with a finished back will be constructed with a fully finished, fixed modesty panel.</p>
<b>Pull Hardware Options</b>	<p>Mercer products are standard with the Nash pull in a satin nickel finish. These products may also be specified with any of the pulls from HBF's Courant, Legacy, Ashton or Fairmont product lines. <b>Each order must specify pull and finish before order entry can proceed.</b></p> <div data-bbox="451 1409 867 1619" data-label="Image"></div>
<b>Locks</b>	<p>All pedestals are standard with face locks. All credenza storage towers, vertical storage cabinets, overhead cabinets and bookcases with doors are available with optional face locks. <b>Add \$95 List</b> per lock for factory installation. (Locks standard on vertical cabinet file drawers)</p> <p>Each individual unit (i.e. desk, credenza, overhead storage unit, etc.) will be keyed alike. Lock finish will match pull finish unless specified otherwise. If complete offices are required to be keyed alike, this designation must appear on each order. Units will be shipped with the lock barrels and locking mechanisms in place. A separate package will contain the appropriately numbered cylinders for field installations. If no specific lock instructions accompany the order, random keying between complete units will be installed.</p>

# HBF Mercer Casegood Specifications

## Grommets

Grommets are optional on all Mercer desks, credenzas, returns, bridges, table desks, corner units and desk extensions. **Add \$95 List** for each factory installed grommet. Field installed circular grommets are available, **add \$40 List**. Finishes available are satin nickel, matte black powder coat and polished brass and will match specified finish for the pull hardware, unless otherwise noted. The 2" circular grommet is used on all desks and desk extensions. The 3" circular grommet is used on all credenzas, returns, bridges, and corner units.



For added convenience, the drawings below should be used to define the placement of each optional grommet location. Please attach a copy to the order.

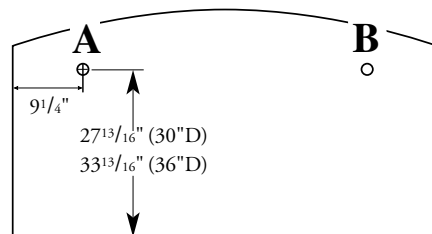

Desk- Bow Front Top

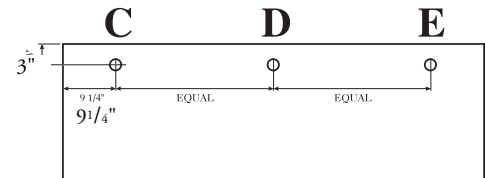

Credenza, Return, Bridge

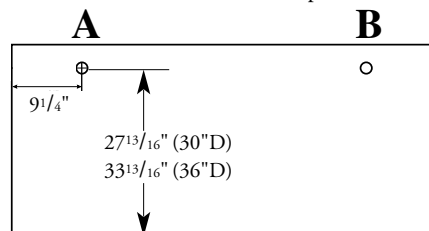

Desk - Rectangular Top

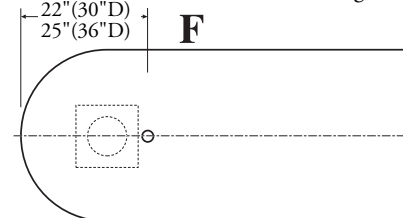

All Desk Extensions

If standard grommet placement locations do not provide suitable accessibility, a formal drawing of specified grommet location showing exact dimensions must accompany the order. No order specifying non-standard grommet placement will be entered until these drawings are received and approved by HBF.

## Mobile Audio/Visual Cart Electrical Access

The Mercer mobile audio/visual cart may be specified with a power/data unit that can be mounted to any surface on the cart. The unit is standard in a black finish and will be supplied for the end user to mount as needed to meet their specific requirements. Specify **AC96NB**, add **\$295 List**.

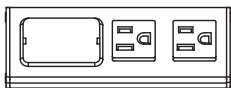

This power/data unit provides two 110 volt electrical outlets and two data jacks. The unit uses a soft cord with grounded plug.

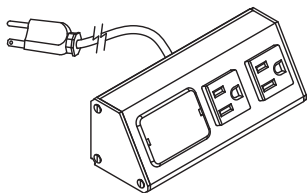

The electrical components provided within this group of furniture are engineered and manufactured in compliance with NEC regulation, **however it is the responsibility of the specifier and contracted installer of the furniture to be aware of the local building and electrical restrictions.** Electrical components meet both Chicago and New York electrical codes.

# HBF Mercer Casegoods - Desks

Style Number	List Price			Dimensions			Weight
	Veneer 1	Veneer 2	Veneer 3	OW	OD	OH	

## Rectangular Double Pedestal Desk - Recessed Modesty Panel

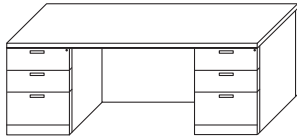

ME01A-AHA	4362	4711	5234	66	30	29	442
ME01C-AHA	4444	4800	5333	66	36	29	461
ME01D-AHA	4444	4800	5333	72	30	29	447
ME01F-AHA	4527	4889	5432	72	36	29	476
ME01G-AHA	4867	5256	5840	78	36	29	499

Veneer species must be noted on each line item

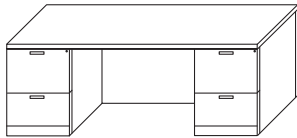

ME01A-BHB	4362	4711	5234	66	30	29	442
ME01C-BHB	4444	4800	5333	66	36	29	461
ME01D-BHB	4444	4800	5333	72	30	29	447
ME01F-BHB	4527	4889	5432	72	36	29	476
ME01G-BHB	4867	5256	5840	78	36	29	499

Veneer species must be noted on each line item

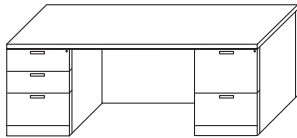

ME01A-AHB	4362	4711	5234	66	30	29	442
ME01C-AHB	4444	4800	5333	66	36	29	461
ME01D-AHB	4444	4800	5333	72	30	29	447
ME01F-AHB	4527	4889	5432	72	36	29	476
ME01G-AHB	4867	5256	5840	78	36	29	499

Veneer species must be noted on each line item

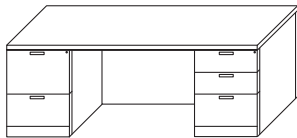

ME01A-BHA	4362	4711	5234	66	30	29	442
ME01C-BHA	4444	4800	5333	66	36	29	461
ME01D-BHA	4444	4800	5333	72	30	29	447
ME01F-BHA	4527	4889	5432	72	36	29	476
ME01G-BHA	4867	5256	5840	78	36	29	499

Veneer species must be noted on each line item

## Rectangular Double Pedestal Desk - Flush Modesty Panel

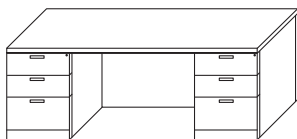

ME02A-AHA	4280	4622	5136	66	30	29	442
ME02C-AHA	4362	4711	5234	66	36	29	461
ME02D-AHA	4362	4711	5234	72	30	29	447
ME02F-AHA	4444	4800	5333	72	36	29	476
ME02G-AHA	4784	5167	5741	78	36	29	499

Veneer species must be noted on each line item

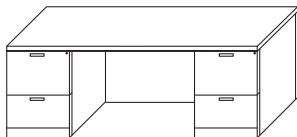

ME02A-BHB	4280	4622	5136	66	30	29	442
ME02C-BHB	4362	4711	5234	66	36	29	461
ME02D-BHB	4362	4711	5234	72	30	29	447
ME02F-BHB	4444	4800	5333	72	36	29	476
ME02G-BHB	4784	5167	5741	78	36	29	499

Veneer species must be noted on each line item

Veneer species must be noted on each line item

Veneer Grade 1	Veneer Grade 2	Veneer Grade 3
Cherry	Rift Oak	Anigre
Maple	Sapele	
Ligno-Grain		
Walnut		

# HBF Mercer Casegoods - Desks

Style Number	List Price			Dimensions			Weight
	Veneer 1	Veneer 2	Veneer 3	OW	OD	OH	

## Rectangular Double Pedestal Desk - Flush Modesty Panel

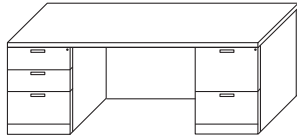

ME02A-AHB	4280	4622	5136	66	30	29	442
ME02C-AHB	4362	4711	5234	66	36	29	461
ME02D-AHB	4362	4711	5234	72	30	29	447
ME02F-AHB	4444	4800	5333	72	36	29	476
ME02G-AHB	4784	5167	5741	78	36	29	499

Veneer species must be noted on each line item

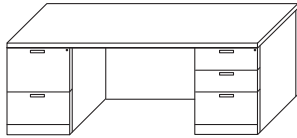

ME02A-BHA	4280	4622	5136	66	30	29	442
ME02C-BHA	4362	4711	5234	66	36	29	461
ME02D-BHA	4362	4711	5234	72	30	29	447
ME02F-BHA	4444	4800	5333	72	36	29	476
ME02G-BHA	4784	5167	5741	78	36	29	499

Veneer species must be noted on each line item

## Rectangular Double Pedestal Desk - Recessed Modesty Panel, Front Overhang

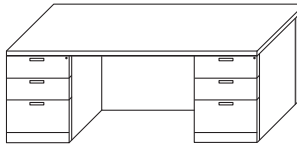

ME05C-AHA	4383	4733	5259	66	36	29	442
ME05H-AHA	4465	4822	5358	66	42	29	461
ME05F-AHA	4486	4845	5383	72	36	29	447
ME05J-AHA	4547	4911	5457	72	42	29	476
ME05K-AHA	4815	5200	5778	78	42	29	499

Veneer species must be noted on each line item

6" overhang visitor side

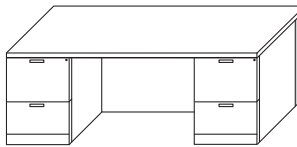

ME05C-BHB	4383	4733	5259	66	36	29	442
ME05H-BHB	4465	4822	5358	66	42	29	461
ME05F-BHB	4486	4845	5383	72	36	29	447
ME05J-BHB	4547	4911	5457	72	42	29	476
ME05K-BHB	4815	5200	5778	78	42	29	499

Veneer species must be noted on each line item

6" overhang visitor side

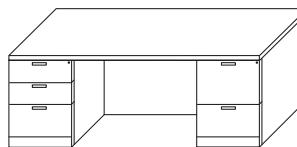

AS05C-AHB	4383	4733	5259	66	36	29	442
AS05H-AHB	4465	4822	5358	66	42	29	461
AS05F-AHB	4486	4845	5383	72	36	29	447
AS05J-AHB	4547	4911	5457	72	42	29	476
AS05K-AHB	4815	5200	5778	78	42	29	499

Veneer species must be noted on each line item

6" overhang visitor side

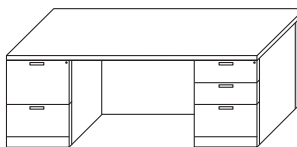

AS05C-BHA	4383	4733	5259	66	36	29	442
AS05H-BHA	4465	4822	5358	66	42	29	461
AS05F-BHA	4486	4845	5383	72	36	29	447
AS05J-BHA	4547	4911	5457	72	42	29	476
AS05K-BHA	4815	5200	5778	78	42	29	499

Veneer species must be noted on each line item

6" overhang visitor side

### Veneer species must be noted on each line item

Veneer Grade 1	Veneer Grade 2	Veneer Grade 3
Cherry	Rift Oak	Anigre
Maple	Sapele	
Ligno-Grain		
Walnut		

# HBF Mercer Casegoods - Desks

Style Number	List Price			Dimensions			Weight
	Veneer 1	Veneer 2	Veneer 3	OW	OD	OH	

## Rectangular Double Pedestal Desk - Flush Modesty Panel, Front Overhang

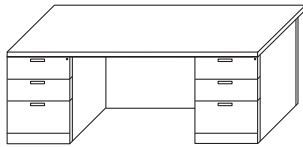

ME06C-AHA	4300	4644	5160	66	36	29	442
ME06H-AHA	4383	4733	5259	66	42	29	461
ME06F-AHA	4403	4756	5284	72	36	29	447
ME06J-AHA	4465	4822	5358	72	42	29	476
ME06K-AHA	4733	5111	5679	78	42	29	499

Veneer species must be noted on each line item

6" overhang visitor side

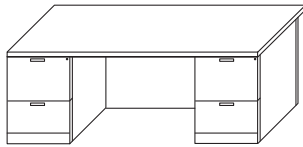

ME06C-BHB	4300	4644	5160	66	36	29	442
ME06H-BHB	4383	4733	5259	66	42	29	461
ME06F-BHB	4403	4756	5284	72	36	29	447
ME06J-BHB	4465	4822	5358	72	42	29	476
ME06K-BHB	4733	5111	5679	78	42	29	499

Veneer species must be noted on each line item

6" overhang visitor side

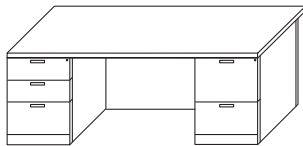

ME06C-AHB	4300	4644	5160	66	36	29	442
ME06H-AHB	4383	4733	5259	66	42	29	461
ME06F-AHB	4403	4756	5284	72	36	29	447
ME06J-AHB	4465	4822	5358	72	42	29	476
ME06K-AHB	4733	5111	5679	78	42	29	499

Veneer species must be noted on each line item

6" overhang visitor side

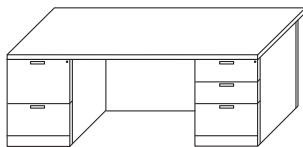

ME06C-BHA	4300	4644	5160	66	36	29	442
ME06H-BHA	4383	4733	5259	66	42	29	461
ME06F-BHA	4403	4756	5284	72	36	29	447
ME06J-BHA	4465	4822	5358	72	42	29	476
ME06K-BHA	4733	5111	5679	78	42	29	499

Veneer species must be noted on each line item

6" overhang visitor side

## Bow Front Double Pedestal Desk - Recessed Modesty Panel

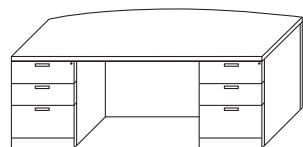

ME03A-AHA	5114	5523	6137	66	30/36	29	464
ME03C-AHA	5207	5623	6248	66	36/42	29	484
ME03D-AHA	5207	5623	6248	72	30/36	29	487
ME03F-AHA	5299	5723	6359	72	36/42	29	508
ME03G-AHA	5670	6124	6804	78	36/42	29	532

Veneer species must be noted on each line item

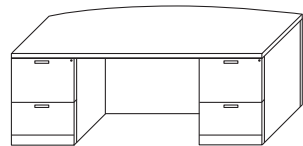

ME03A-BHB	5114	5523	6137	66	30/36	29	464
ME03C-BHB	5207	5623	6248	66	36/42	29	484
ME03D-BHB	5207	5623	6248	72	30/36	29	487
ME03F-BHB	5299	5723	6359	72	36/42	29	508
ME03G-BHB	5670	6124	6804	78	36/42	29	532

Veneer species must be noted on each line item

Veneer species must be noted on each line item

Veneer Grade 1	Veneer Grade 2	Veneer Grade 3
Cherry	Rift Oak	Anigre
Maple	Sapele	
Ligno-Grain		
Walnut		



# HBF Mercer Casegoods - Desks

Style Number	List Price			Dimensions			Weight
	Veneer 1	Veneer 2	Veneer 3	OW	OD	OH	

## Bow Front Double Pedestal Desk - Recessed Modesty Panel

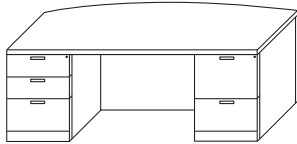

ME03A-AHB	5114	5523	6137	66	30/36	29	464
ME03C-AHB	5207	5623	6248	66	36/42	29	484
ME03D-AHB	5207	5623	6248	72	30/36	29	487
ME03F-AHB	5299	5723	6359	72	36/42	29	508
ME03G-AHB	5670	6124	6804	78	36/42	29	532

Veneer species must be noted on each line item

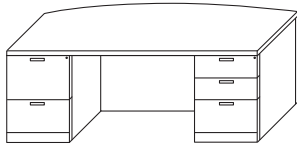

ME03A-BHA	5114	5523	6137	66	30/36	29	464
ME03C-BHA	5207	5623	6248	66	36/42	29	484
ME03D-BHA	5207	5623	6248	72	30/36	29	487
ME03F-BHA	5299	5723	6359	72	36/42	29	508
ME03G-BHA	5670	6124	6804	78	36/42	29	532

Veneer species must be noted on each line item

## Bow Front Double Pedestal Desk - Flush Modesty Panel

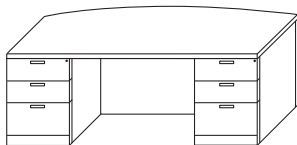

ME04A-AHA	5032	5434	6038	66	30/36	29	464
ME04C-AHA	5124	5534	6149	66	36/42	29	484
ME04D-AHA	5124	5534	6149	72	30/36	29	487
ME04F-AHA	5217	5634	6260	72	36/42	29	508
ME04G-AHA	5588	6035	6705	78	36/42	29	532

Veneer species must be noted on each line item

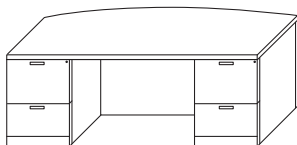

ME04A-BHB	5032	5434	6038	66	30/36	29	464
ME04C-BHB	5124	5534	6149	66	36/42	29	484
ME04D-BHB	5124	5534	6149	72	30/36	29	487
ME04F-BHB	5217	5634	6260	72	36/42	29	508
ME04G-BHB	5588	6035	6705	78	36/42	29	532

Veneer species must be noted on each line item

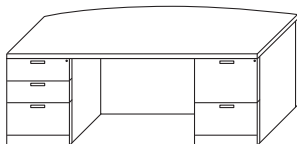

ME04A-AHB	5032	5434	6038	66	30/36	29	464
ME04C-AHB	5124	5534	6149	66	36/42	29	484
ME04D-AHB	5124	5534	6149	72	30/36	29	487
ME04F-AHB	5217	5634	6260	72	36/42	29	508
ME04G-AHB	5588	6035	6705	78	36/42	29	532

Veneer species must be noted on each line item

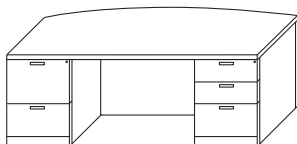

ME04A-BHA	5032	5434	6038	66	30/36	29	464
ME04C-BHA	5124	5534	6149	66	36/42	29	484
ME04D-BHA	5124	5534	6149	72	30/36	29	487
ME04F-BHA	5217	5634	6260	72	36/42	29	508
ME04G-BHA	5588	6035	6705	78	36/42	29	532

Veneer species must be noted on each line item

Veneer species must be noted on each line item

Veneer Grade 1	Veneer Grade 2	Veneer Grade 3
Cherry	Rift Oak	Anigre
Maple	Sapele	
Ligno-Grain		
Walnut		

# HBF Mercer Casegoods - Desks

Style Number	List Price			Dimensions			Weight
	Veneer 1	Veneer 2	Veneer 3	OW	OD	OH	

## Rectangular Single Pedestal Desk - Recessed Modesty Panel

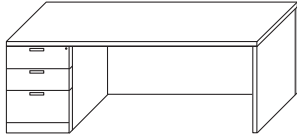

ME10A-AHK	3620	3910	4345	66	30	29	419
ME10C-AHK	3693	3988	4431	66	36	29	439
ME10D-AHK	3693	3988	4431	72	30	29	425
ME10F-AHK	3775	4077	4530	72	36	29	455
ME10G-AHK	4115	4444	4938	78	36	29	479

Veneer species must be noted on each line item

Flush, finished end panels, used with finished back returns and bridges.

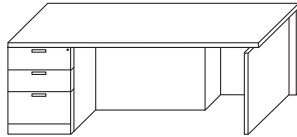

ME10A-AHL	3517	3799	4221	66	30	29	419
ME10C-AHL	3590	3877	4307	66	36	29	439
ME10D-AHL	3590	3877	4307	72	30	29	425
ME10F-AHL	3672	3966	4406	72	36	29	455
ME10G-AHL	4012	4333	4814	78	36	29	479

Veneer species must be noted on each line item

Recessed end panels, used with returns and bridges with removable backs. Standard black outside finish to allow placement against wall.

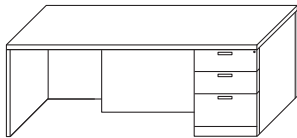

ME10A-KHA	3620	3910	4345	66	30	29	419
ME10C-KHA	3693	3988	4431	66	36	29	439
ME10D-KHA	3693	3988	4431	72	30	29	425
ME10F-KHA	3775	4077	4530	72	36	29	455
ME10G-KHA	4115	4444	4938	78	36	29	479

Veneer species must be noted on each line item

Flush, finished end panels, used with finished back returns and bridges.

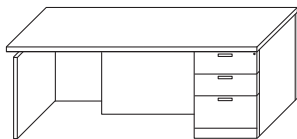

ME10A-LHA	3517	3799	4221	66	30	29	419
ME10C-LHA	3590	3877	4307	66	36	29	439
ME10D-LHA	3590	3877	4307	72	30	29	425
ME10F-LHA	3672	3966	4406	72	36	29	455
ME10G-LHA	4012	4333	4814	78	36	29	479

Veneer species must be noted on each line item

Recessed end panels, used with returns and bridges with removable backs. Standard black outside finish to allow placement against wall.

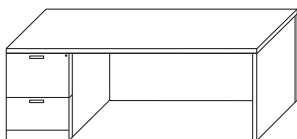

ME10A-BHK	3620	3910	4345	66	30	29	419
ME10C-BHK	3693	3988	4431	66	36	29	439
ME10D-BHK	3693	3988	4431	72	30	29	425
ME10F-BHK	3775	4077	4530	72	36	29	455
ME10G-BHK	4115	4444	4938	78	36	29	479

Veneer species must be noted on each line item

Flush, finished end panels, used with finished back returns and bridges.

### Veneer species must be noted on each line item

Veneer Grade 1	Veneer Grade 2	Veneer Grade 3
Cherry	Rift Oak	Anigre
Maple	Sapele	
Ligno-Grain		
Walnut		

# HBF Mercer Casegoods - Desks

Style Number	List Price			Dimensions			Weight
	Veneer 1	Veneer 2	Veneer 3	OW	OD	OH	

## Rectangular Single Pedestal Desk - Recessed Modesty Panel

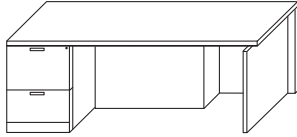

ME10A-BHL	3517	3799	4221	66	30	29	419
ME10C-BHL	3590	3877	4307	66	36	29	439
ME10D-BHL	3590	3877	4307	72	30	29	425
ME10F-BHL	3672	3966	4406	72	36	29	455
ME10G-BHL	4012	4333	4814	78	36	29	479

Veneer species must be noted on each line item

Recessed end panels, used with returns and bridges with removable backs. Standard black outside finish to allow placement against wall.

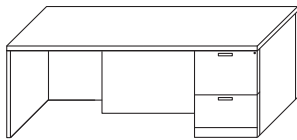

ME10A-KHB	3620	3910	4345	66	30	29	419
ME10C-KHB	3693	3988	4431	66	36	29	439
ME10D-KHB	3693	3988	4431	72	30	29	425
ME10F-KHB	3775	4077	4530	72	36	29	455
ME10G-KHB	4115	4444	4938	78	36	29	479

Veneer species must be noted on each line item

Flush, finished end panels, used with finished back returns and bridges.

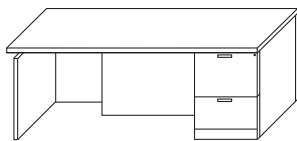

ME10A-LHB	3517	3799	4221	66	30	29	419
ME10C-LHB	3590	3877	4307	66	36	29	439
ME10D-LHB	3590	3877	4307	72	30	29	425
ME10F-LHB	3672	3966	4406	72	36	29	455
ME10G-LHB	4012	4333	4814	78	36	29	479

Veneer species must be noted on each line item

Recessed end panels, used with returns and bridges with removable backs. Standard black outside finish to allow placement against wall.

## Rectangular Single Pedestal Desk - Flush Modesty Panel

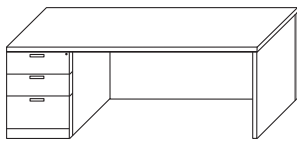

ME11A-AHK	3538	3821	4246	66	30	29	419
ME11C-AHK	3610	3899	4332	66	36	29	439
ME11D-AHK	3610	3899	4332	72	30	29	425
ME11F-AHK	3693	3988	4431	72	36	29	455
ME11G-AHK	4032	4355	4839	78	36	29	479

Veneer species must be noted on each line item

Flush, finished end panels, used with finished back returns and bridges.

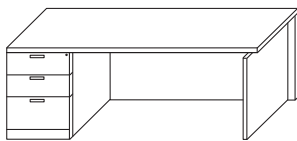

ME11A-AHL	3435	3710	4122	66	30	29	419
ME11C-AHL	3507	3788	4209	66	36	29	439
ME11D-AHL	3507	3788	4209	72	30	29	425
ME11F-AHL	3590	3877	4307	72	36	29	455
ME11G-AHL	3929	4244	4715	78	36	29	479

Veneer species must be noted on each line item

Recessed end panels, used with returns and bridges with removable backs. Standard black outside finish to allow placement against wall.

### Veneer species must be noted on each line item

Veneer Grade 1	Veneer Grade 2	Veneer Grade 3
Cherry	Rift Oak	Anigre
Maple	Sapele	
Ligno-Grain		
Walnut		

# HBF Mercer Casegoods - Desks

Style Number	List Price			Dimensions			Weight
	Veneer 1	Veneer 2	Veneer 3	OW	OD	OH	

## Rectangular Single Pedestal Desk - Flush Modesty Panel

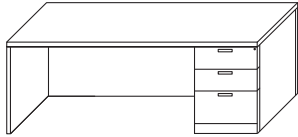

ME11A-KHA	3538	3821	4246	66	30	29	419
ME11C-KHA	3610	3899	4332	66	36	29	439
ME11D-KHA	3610	3899	4332	72	30	29	425
ME11F-KHA	3693	3988	4431	72	36	29	455
ME11G-KHA	4032	4355	4839	78	36	29	479

Veneer species must be noted on each line item

Flush, finished end panels, used with finished back returns and bridges.

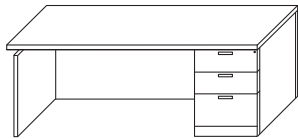

ME11A-LHA	3435	3710	4122	66	30	29	419
ME11C-LHA	3507	3788	4209	66	36	29	439
ME11D-LHA	3507	3788	4209	72	30	29	425
ME11F-LHA	3590	3877	4307	72	36	29	455
ME11G-LHA	3929	4244	4715	78	36	29	479

Veneer species must be noted on each line item

Recessed end panels, used with returns and bridges with removable backs. Standard black outside finish to allow placement against wall.

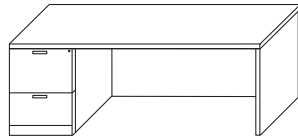

ME11A-BHK	3538	3821	4246	66	30	29	419
ME11C-BHK	3610	3899	4332	66	36	29	439
ME11D-BHK	3610	3899	4332	72	30	29	425
ME11F-BHK	3693	3988	4431	72	36	29	455
ME11G-BHK	4032	4355	4839	78	36	29	479

Veneer species must be noted on each line item

Flush, finished end panels, used with finished back returns and bridges.

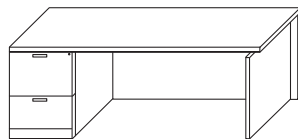

ME11A-BHL	3435	3710	4122	66	30	29	419
ME11C-BHL	3507	3788	4209	66	36	29	439
ME11D-BHL	3507	3788	4209	72	30	29	425
ME11F-BHL	3590	3877	4307	72	36	29	455
ME11G-BHL	3929	4244	4715	78	36	29	479

Veneer species must be noted on each line item

Recessed end panels, used with returns and bridges with removable backs. Standard black outside finish to allow placement against wall.

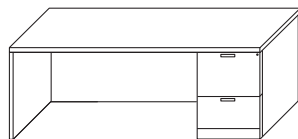

ME11A-KHB	3538	3821	4246	66	30	29	419
ME11C-KHB	3610	3899	4332	66	36	29	439
ME11D-KHB	3610	3899	4332	72	30	29	425
ME11F-KHB	3693	3988	4431	72	36	29	455
ME11G-KHB	4032	4355	4839	78	36	29	479

Veneer species must be noted on each line item

Flush, finished end panels, used with finished back returns and bridges.

### Veneer species must be noted on each line item

Veneer Grade 1	Veneer Grade 2	Veneer Grade 3
Cherry	Rift Oak	Anigre
Maple	Sapele	
Ligno-Grain		
Walnut		

# HBF Mercer Casegoods - Desks

Style Number	List Price			Dimensions			Weight
	Veneer 1	Veneer 2	Veneer 3	OW	OD	OH	

## Rectangular Single Pedestal Desk - Flush Modesty Panel

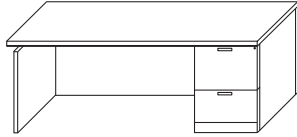

ME11A-LHB	3435	3710	4122	66	30	29	419
ME11C-LHB	3507	3788	4209	66	36	29	439
ME11D-LHB	3507	3788	4209	72	30	29	425
ME11F-LHB	3590	3877	4307	72	36	29	455
ME11G-LHB	3929	4244	4715	78	36	29	479

Veneer species must be noted on each line item

Recessed end panels, used with returns and bridges with removable backs. Standard black outside finish to allow placement against wall.

## Rectangular Single Pedestal Desk - Recessed Modesty Panel, Front Overhang

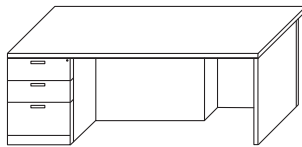

ME08C-AHK	3641	3932	4369	66	36	29	419
ME08H-AHK	3713	4010	4456	66	42	29	439
ME08F-AHK	3713	4010	4456	72	36	29	425
ME08J-AHK	3796	4099	4555	72	42	29	455
ME08K-AHK	4135	4466	4963	78	42	29	479

Veneer species must be noted on each line item

Flush, finished end panels, used with finished back returns and bridges. 6" overhang visitor side.

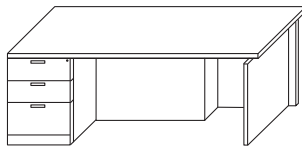

ME08C-AHL	3538	3821	4246	66	36	29	419
ME08H-AHL	3610	3899	4332	66	42	29	439
ME08F-AHL	3610	3899	4332	72	36	29	425
ME08J-AHL	3693	3988	4431	72	42	29	455
ME08K-AHL	4032	4355	4839	78	42	29	479

Veneer species must be noted on each line item

Recessed end panels, used with returns and bridges with removable backs. Standard black outside finish to allow placement against wall. 6" overhang visitor side.

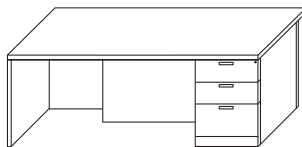

ME08C-KHA	3641	3932	4369	66	36	29	419
ME08H-KHA	3713	4010	4456	66	42	29	439
ME08F-KHA	3713	4010	4456	72	36	29	425
ME08J-KHA	3796	4099	4555	72	42	29	455
ME08K-KHA	4135	4466	4963	78	42	29	479

Veneer species must be noted on each line item

Flush, finished end panels, used with finished back returns and bridges. 6" overhang visitor side.

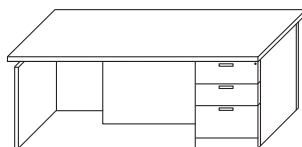

ME08C-LHA	3538	3821	4246	66	36	29	419
ME08H-LHA	3610	3899	4332	66	42	29	439
ME08F-LHA	3610	3899	4332	72	36	29	425
ME08J-LHA	3693	3988	4431	72	42	29	455
ME08K-LHA	4032	4355	4839	78	42	29	479

Veneer species must be noted on each line item

Recessed end panels, used with returns and bridges with removable backs. Standard black outside finish to allow placement against wall. 6" overhang visitor side.

### Veneer species must be noted on each line item

Veneer Grade 1	Veneer Grade 2	Veneer Grade 3
Cherry	Rift Oak	Anigre
Maple	Sapele	
Ligno-Grain		
Walnut		

# HBF Mercer Casegoods - Desks

Style Number	List Price			Dimensions			Weight
	Veneer 1	Veneer 2	Veneer 3	OW	OD	OH	

## Rectangular Single Pedestal Desk - Recessed Modesty Panel, Front Overhang

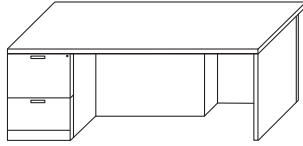

ME08C-BHK	3641	3932	4369	66	36	29	419
ME08H-BHK	3713	4010	4456	66	42	29	439
ME08F-BHK	3713	4010	4456	72	36	29	425
ME08J-BHK	3796	4099	4555	72	42	29	455
ME08K-BHK	4135	4466	4963	78	42	29	479

Veneer species must be noted on each line item

Flush, finished end panels, used with finished back returns and bridges. 6" overhang visitor side.

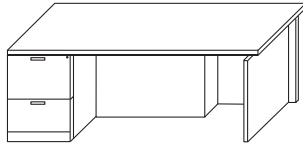

ME08C-BHL	3538	3821	4246	66	36	29	419
ME08H-BHL	3610	3899	4332	66	42	29	439
ME08F-BHL	3610	3899	4332	72	36	29	425
ME08J-BHL	3693	3988	4431	72	42	29	455
ME08K-BHL	4032	4355	4839	78	42	29	479

Veneer species must be noted on each line item

Recessed end panels, used with returns and bridges with removable backs. Standard black outside finish to allow placement against wall. 6" overhang visitor side.

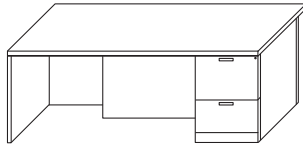

ME08C-KHB	3641	3932	4369	66	36	29	419
ME08H-KHB	3713	4010	4456	66	42	29	439
ME08F-KHB	3713	4010	4456	72	36	29	425
ME08J-KHB	3796	4099	4555	72	42	29	455
ME08K-KHB	4135	4466	4963	78	42	29	479

Veneer species must be noted on each line item

Flush, finished end panels, used with finished back returns and bridges. 6" overhang visitor side.

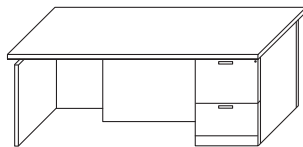

ME08C-LHB	3538	3821	4246	66	36	29	419
ME08H-LHB	3610	3899	4332	66	42	29	439
ME08F-LHB	3610	3899	4332	72	36	29	425
ME08J-LHB	3693	3988	4431	72	42	29	455
ME08K-LHB	4032	4355	4839	78	42	29	479

Veneer species must be noted on each line item

Recessed end panels, used with returns and bridges with removable backs. Standard black outside finish to allow placement against wall. 6" overhang visitor side.

## Rectangular Single Pedestal Desk - Flush Modesty Panel, Front Overhang

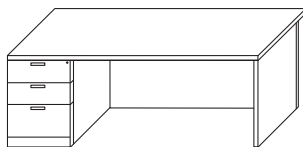

ME09C-AHK	3559	3843	4270	66	36	29	419
ME09H-AHK	3631	3921	4357	66	42	29	439
ME09F-AHK	3631	3921	4357	72	36	29	425
ME09J-AHK	3713	4010	4456	72	42	29	455
ME09K-AHK	4053	4377	4864	78	42	29	479

Veneer species must be noted on each line item

Flush, finished end panels, used with finished back returns and bridges. 6" overhang visitor side.

### Veneer species must be noted on each line item

Veneer Grade 1	Veneer Grade 2	Veneer Grade 3
Cherry	Rift Oak	Anigre
Maple	Sapele	
Ligno-Grain		
Walnut		

# HBF Mercer Casegoods - Desks

Style Number	List Price			Dimensions			Weight
	Veneer 1	Veneer 2	Veneer 3	OW	OD	OH	

## Rectangular Single Pedestal Desk - Flush Modesty Panel, Front Overhang

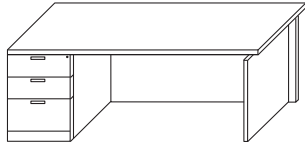

ME09C-AHL	3456	3732	4147	66	36	29	419
ME09H-AHL	3528	3810	4233	66	42	29	439
ME09F-AHL	3528	3810	4233	72	36	29	425
ME09J-AHL	3610	3899	4332	72	42	29	455
ME09K-AHL	3950	4266	4740	78	42	29	479

Veneer species must be noted on each line item

Recessed end panels, used with returns and bridges with removable backs. Standard black outside finish to allow placement against wall. 6" overhang visitor side.

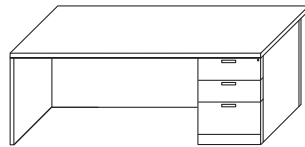

ME09C-KHA	3559	3843	4270	66	36	29	419
ME09H-KHA	3631	3921	4357	66	42	29	439
ME09F-KHA	3631	3921	4357	72	36	29	425
ME09J-KHA	3713	4010	4456	72	42	29	455
ME09K-KHA	4053	4377	4864	78	42	29	479

Veneer species must be noted on each line item

Flush, finished end panels, used with finished back returns and bridges. 6" overhang visitor side.

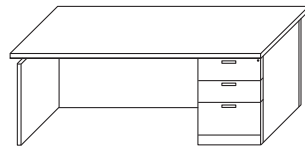

ME09C-LHA	3456	3732	4147	66	36	29	419
ME09H-LHA	3528	3810	4233	66	42	29	439
ME09F-LHA	3528	3810	4233	72	36	29	425
ME09J-LHA	3610	3899	4332	72	42	29	455
ME09K-LHA	3950	4266	4740	78	42	29	479

Veneer species must be noted on each line item

Recessed end panels, used with returns and bridges with removable backs. Standard black outside finish to allow placement against wall. 6" overhang visitor side.

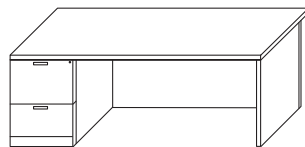

ME09C-BHK	3559	3843	4270	66	36	29	419
ME09H-BHK	3631	3921	4357	66	42	29	439
ME09F-BHK	3631	3921	4357	72	36	29	425
ME09J-BHK	3713	4010	4456	72	42	29	455
ME09K-BHK	4053	4377	4864	78	42	29	479

Veneer species must be noted on each line item

Flush, finished end panels, used with finished back returns and bridges. 6" overhang visitor side.

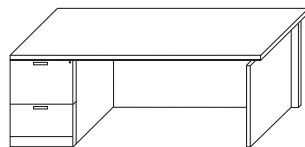

ME09C-BHL	3456	3732	4147	66	36	29	419
ME09H-BHL	3528	3810	4233	66	42	29	439
ME09F-BHL	3528	3810	4233	72	36	29	425
ME09J-BHL	3610	3899	4332	72	42	29	455
ME09K-BHL	3950	4266	4740	78	42	29	479

Veneer species must be noted on each line item

Recessed end panels, used with returns and bridges with removable backs. Standard black outside finish to allow placement against wall. 6" overhang visitor side.

### Veneer species must be noted on each line item

Veneer Grade 1	Veneer Grade 2	Veneer Grade 3
Cherry	Rift Oak	Anigre
Maple	Sapele	
Ligno-Grain		
Walnut		

# HBF Mercer Casegoods - Desks

Style Number	List Price			Dimensions			Weight
	Veneer 1	Veneer 2	Veneer 3	OW	OD	OH	

## Rectangular Single Pedestal Desk - Flush Modesty Panel, Front Overhang

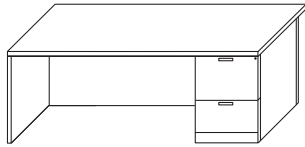

ME09C-KHB	3559	3843	4270	66	36	29	419
ME09H-KHB	3631	3921	4357	66	42	29	439
ME09F-KHB	3631	3921	4357	72	36	29	425
ME09J-KHB	3713	4010	4456	72	42	29	455
ME09K-KHB	4053	4377	4864	78	42	29	479

Veneer species must be noted on each line item

Flush, finished end panels, used with finished back returns and bridges. 6" overhang visitor side.

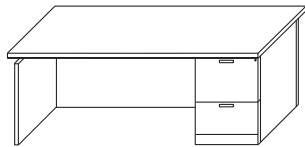

ME09C-LHB	3456	3732	4147	66	36	29	419
ME09H-LHB	3528	3810	4233	66	42	29	439
ME09F-LHB	3528	3810	4233	72	36	29	425
ME09J-LHB	3610	3899	4332	72	42	29	455
ME09K-LHB	3950	4266	4740	78	42	29	479

Veneer species must be noted on each line item

Recessed end panels, used with returns and bridges with removable backs. Standard black outside finish to allow placement against wall. 6" overhang visitor side.

## Bow Front Single Pedestal Desk - Recessed Modesty Panel

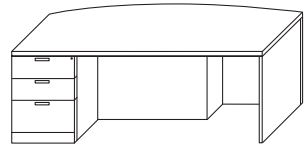

ME12A-AHK	4372	4722	5247	66	30/36	29	443
ME12C-AHK	4444	4800	5333	66	36/42	29	464
ME12D-AHK	4444	4800	5333	72	30/36	29	466
ME12F-AHK	4527	4889	5432	72	36/42	29	488
ME12G-AHK	4867	5256	5840	78	36/42	29	514

Veneer species must be noted on each line item

Flush, finished end panels, used with finished back returns and bridges.

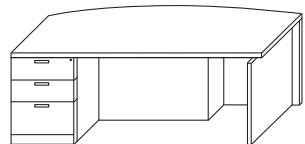

ME12A-AHL	4269	4611	5123	66	30/36	29	443
ME12C-AHL	4341	4689	5210	66	36/42	29	464
ME12D-AHL	4341	4689	5210	72	30/36	29	466
ME12F-AHL	4424	4778	5309	72	36/42	29	488
ME12G-AHL	4764	5145	5717	78	36/42	29	514

Veneer species must be noted on each line item

Recessed end panels, used with returns and bridges with removable backs. Standard black outside finish to allow placement against wall.

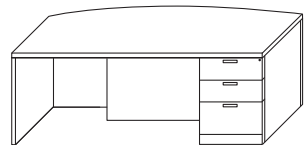

ME12A-KHA	4372	4722	5247	66	30/36	29	443
ME12C-KHA	4444	4800	5333	66	36/42	29	464
ME12D-KHA	4444	4800	5333	72	30/36	29	466
ME12F-KHA	4527	4889	5432	72	36/42	29	488
ME12G-KHA	4867	5256	5840	78	36/42	29	514

Veneer species must be noted on each line item

Flush, finished end panels, used with finished back returns and bridges.

### Veneer species must be noted on each line item

Veneer Grade 1	Veneer Grade 2	Veneer Grade 3
Cherry	Rift Oak	Anigre
Maple	Sapele	
Ligno-Grain		
Walnut		



# HBF Mercer Casegoods - Desks

Style Number	List Price			Dimensions			Weight
	Veneer 1	Veneer 2	Veneer 3	OW	OD	OH	

## Bow Front Single Pedestal Desk - Recessed Modesty Panel

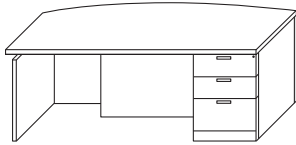

ME12A-LHA	4269	4611	5123	66	30/36	29	443
ME12C-LHA	4341	4689	5210	66	36/42	29	464
ME12D-LHA	4341	4689	5210	72	30/36	29	466
ME12F-LHA	4424	4778	5309	72	36/42	29	488
ME12G-LHA	4764	5145	5717	78	36/42	29	514

Veneer species must be noted on each line item

Recessed end panels, used with returns and bridges with removable backs. Standard black outside finish to allow placement against wall.

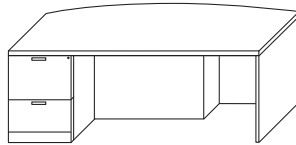

ME12A-BHK	4372	4722	5247	66	30/36	29	443
ME12C-BHK	4444	4800	5333	66	36/42	29	464
ME12D-BHK	4444	4800	5333	72	30/36	29	466
ME12F-BHK	4527	4889	5432	72	36/42	29	488
ME12G-BHK	4867	5256	5840	78	36/42	29	514

Veneer species must be noted on each line item

Flush, finished end panels, used with finished back returns and bridges.

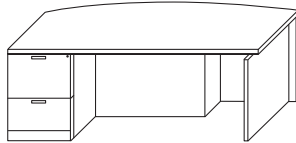

ME12A-BHL	4269	4611	5123	66	30/36	29	443
ME12C-BHL	4341	4689	5210	66	36/42	29	464
ME12D-BHL	4341	4689	5210	72	30/36	29	466
ME12F-BHL	4424	4778	5309	72	36/42	29	488
ME12G-BHL	4764	5145	5717	78	36/42	29	514

Veneer species must be noted on each line item

Recessed end panels, used with returns and bridges with removable backs. Standard black outside finish to allow placement against wall.

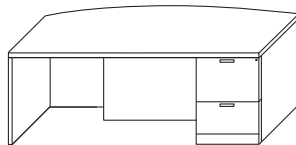

ME12A-KHB	4372	4722	5247	66	30/36	29	443
ME12C-KHB	4444	4800	5333	66	36/42	29	464
ME12D-KHB	4444	4800	5333	72	30/36	29	466
ME12F-KHB	4527	4889	5432	72	36/42	29	488
ME12G-KHB	4867	5256	5840	78	36/42	29	514

Veneer species must be noted on each line item

Flush, finished end panels, used with finished back returns and bridges.

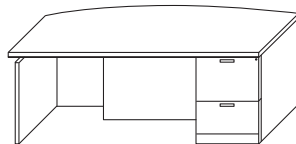

ME12A-LHB	4269	4611	5123	66	30/36	29	443
ME12C-LHB	4341	4689	5210	66	36/42	29	464
ME12D-LHB	4341	4689	5210	72	30/36	29	466
ME12F-LHB	4424	4778	5309	72	36/42	29	488
ME12G-LHB	4764	5145	5717	78	36/42	29	514

Veneer species must be noted on each line item

Recessed end panels, used with returns and bridges with removable backs. Standard black outside finish to allow placement against wall.

### Veneer species must be noted on each line item

Veneer Grade 1	Veneer Grade 2	Veneer Grade 3
Cherry	Rift Oak	Anigre
Maple	Sapele	
Ligno-Grain		
Walnut		

# HBF Mercer Casegoods - Desks

Style Number	List Price			Dimensions			Weight	
	Veneer 1	Veneer 2	Veneer 3	OW	OD	OH		
<b>Bow Front Single Pedestal Desk - Flush Modesty Panel</b>								
	ME13A-AHK	4290	4633	5148	66	30/36	29	443
	ME13C-AHK	4362	4711	5234	66	36/42	29	464
	ME13D-AHK	4362	4711	5234	72	30/36	29	466
	ME13F-AHK	4444	4800	5333	72	36/42	29	488
	ME13G-AHK	4784	5167	5741	78	36/42	29	514

Veneer species must be noted on each line item

Flush, finished end panels, used with finished back returns and bridges.

	ME13A-AHL	4187	4522	5024	66	30/36	29	443
	ME13C-AHL	4259	4600	5111	66	36/42	29	464
	ME13D-AHL	4259	4600	5111	72	30/36	29	466
	ME13F-AHL	4341	4689	5210	72	36/42	29	488
	ME13G-AHL	4681	5056	5618	78	36/42	29	514

Veneer species must be noted on each line item

Recessed end panels, used with returns and bridges with removable backs. Standard black outside finish to allow placement against wall.

	ME13A-KHA	4290	4633	5148	66	30/36	29	443
	ME13C-KHA	4362	4711	5234	66	36/42	29	464
	ME13D-KHA	4362	4711	5234	72	30/36	29	466
	ME13F-KHA	4444	4800	5333	72	36/42	29	488
	ME13G-KHA	4784	5167	5741	78	36/42	29	514

Veneer species must be noted on each line item

Flush, finished end panels, used with finished back returns and bridges.

	ME13A-LHA	4187	4522	5024	66	30/36	29	443
	ME13C-LHA	4259	4600	5111	66	36/42	29	464
	ME13D-LHA	4259	4600	5111	72	30/36	29	466
	ME13F-LHA	4341	4689	5210	72	36/42	29	488
	ME13G-LHA	4681	5056	5618	78	36/42	29	514

Veneer species must be noted on each line item

Recessed end panels, used with returns and bridges with removable backs. Standard black outside finish to allow placement against wall.

	ME13A-BHK	4290	4633	5148	66	30/36	29	443
	ME13C-BHK	4362	4711	5234	66	36/42	29	464
	ME13D-BHK	4362	4711	5234	72	30/36	29	466
	ME13F-BHK	4444	4800	5333	72	36/42	29	488
	ME13G-BHK	4784	5167	5741	78	36/42	29	514

Veneer species must be noted on each line item

Flush, finished end panels, used with finished back returns and bridges.

Veneer species must be noted on each line item

<u>Veneer Grade 1</u>	<u>Veneer Grade 2</u>	<u>Veneer Grade 3</u>
Cherry	Rift Oak	Anigre
Maple	Sapele	
Ligno-Grain		
Walnut		

# HBF Mercer Casegoods - Desks

Style Number	List Price			Dimensions			Weight
	Veneer 1	Veneer 2	Veneer 3	OW	OD	OH	

## Bow Front Single Pedestal Desk - Flush Modesty Panel

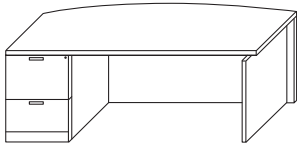

ME13A-BHL	4187	4522	5024	66	30/36	29	443
ME13C-BHL	4259	4600	5111	66	36/42	29	464
ME13D-BHL	4259	4600	5111	72	30/36	29	466
ME13F-BHL	4341	4689	5210	72	36/42	29	488
ME13G-BHL	4681	5056	5618	78	36/42	29	514

Veneer species must be noted on each line item

Recessed end panels, used with returns and bridges with removable backs. Standard black outside finish to allow placement against wall.

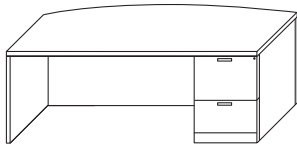

ME13A-KHB	4290	4633	5148	66	30/36	29	443
ME13C-KHB	4362	4711	5234	66	36/42	29	464
ME13D-KHB	4362	4711	5234	72	30/36	29	466
ME13F-KHB	4444	4800	5333	72	36/42	29	488
ME13G-KHB	4784	5167	5741	78	36/42	29	514

Veneer species must be noted on each line item

Flush, finished end panels, used with finished back returns and bridges.

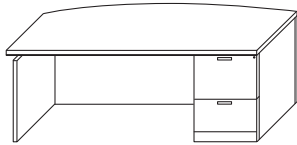

ME13A-LHB	4187	4522	5024	66	30/36	29	443
ME13C-LHB	4259	4600	5111	66	36/42	29	464
ME13D-LHB	4259	4600	5111	72	30/36	29	466
ME13F-LHB	4341	4689	5210	72	36/42	29	488
ME13G-LHB	4681	5056	5618	78	36/42	29	514

Veneer species must be noted on each line item

Recessed end panels, used with returns and bridges with removable backs. Standard black outside finish to allow placement against wall.

### Veneer species must be noted on each line item

Veneer Grade 1	Veneer Grade 2	Veneer Grade 3
Cherry	Rift Oak	Anigre
Maple	Sapele	
Ligno-Grain		
Walnut		

# HBF Mercer Casegoods - Table Desks

Style Number	List Price			Dimensions			Weight
	Veneer 1	Veneer 2	Veneer 3	OW	OD	OH	

## Table Desks

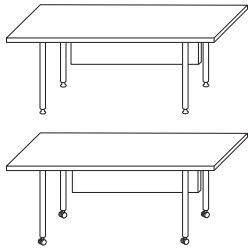

ME07A-T	3322	3587	3986	66	30	29	199
ME07D-T	3353	3621	4023	72	30	29	224
ME07F-T	3425	3699	4110	72	36	29	252

**Veneer species must be noted on each line item**

Center drawer, modesty panel. Metal legs available in satin nickel or black powder coat finish, please specify on order. Casters available on all table desks, please specify on order. Optional border inlay available on top surface of Fairmont only, add \$650 List.

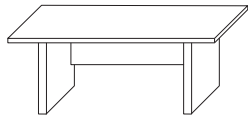

ME07A-M	3950	4266	4740	66	30	29	239
ME07D-M	3971	4288	4765	72	30	29	264
ME07F-M	4053	4377	4864	72	36	29	282

**Veneer species must be noted on each line item**

Center drawer, modesty panel, panel base.  
Optional border inlay available on top surface of Fairmont only, add \$650 List.

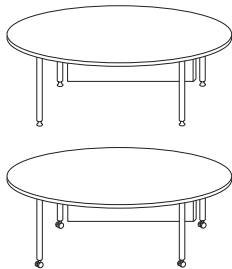

ME18K-T	4197	4533	5037	78	42	29	265
---------	------	------	------	----	----	----	-----

**Veneer species must be noted on each line item**

Ellipse with center drawer, modesty panel. Metal legs available in satin nickel or black powder coat finish, please specify on order. Casters available on all table desks, please specify on order.

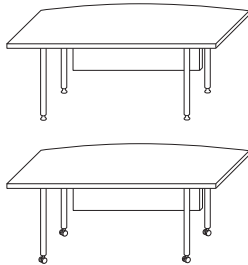

ME19A-T	3940	4255	4728	66	30/36	29	209
ME19D-T	3971	4288	4765	72	30/36	29	234
ME19F-T	4043	4366	4851	72	36/42	29	262

**Veneer species must be noted on each line item**

Bow front with center drawer, modesty panel. Metal legs available in satin nickel or black powder coat finish, please specify on order. Casters available on all table desks, please specify on order. Optional border inlay available on top surface of Fairmont only, add \$650 List.

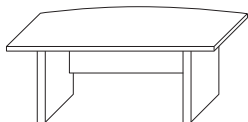

ME19A-M	4568	4933	5482	66	30/36	29	249
ME19D-M	4589	4956	5506	72	30/36	29	274
ME19F-M	4671	5045	5605	72	36/42	29	292

**Veneer species must be noted on each line item**

Bow front with center drawer, modesty panel and panel base.  
Optional border inlay available on top surface of Fairmont only, add \$850 List.

**Veneer species must be noted on each line item**

<u>Veneer Grade 1</u>	<u>Veneer Grade 2</u>	<u>Veneer Grade 3</u>
Cherry	Rift Oak	Anigre
Maple	Sapele	
Ligno-Grain		
Walnut		

# HBF Mercer Casegoods - Credenzas

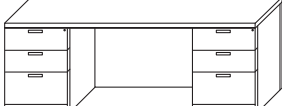
Style Number	List Price			Dimensions			Weight	
	Veneer 1	Veneer 2	Veneer 3	OW	OD	OH		
<b>Double Pedestal Credenza</b>								
	ME31D-AGA	3811	4116	4574	66	24	29	437
	ME31E-AGA	3914	4226	4698	72	24	29	447
	ME31F-AGA	4043	4365	4852	78	24	29	457
	ME31G-AGA	4084	4410	4902	84	24	29	465
	ME31H-AGA	4130	4460	4957	90	24	29	475
	ME31J-AGA	4177	4510	5013	96	24	29	485

Veneer species must be noted on each line item

Removable access panel with standard black unfinished back.

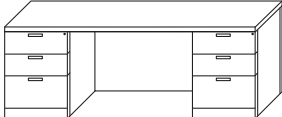
	ME32D-AGA	3811	4116	4574	66	24	29	437
	ME32E-AGA	3914	4226	4698	72	24	29	447
	ME32F-AGA	4043	4365	4852	78	24	29	457
	ME32G-AGA	4084	4410	4902	84	24	29	465
	ME32H-AGA	4130	4460	4957	90	24	29	475
	ME32J-AGA	4177	4510	5013	96	24	29	485

Veneer species must be noted on each line item

Removable access panel with standard black unfinished back.

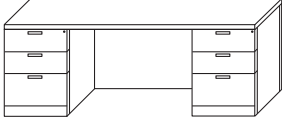
	ME33D-AGA	3811	4116	4574	66	24	29	437
	ME33E-AGA	3914	4226	4698	72	24	29	447
	ME33F-AGA	4043	4365	4852	78	24	29	457
	ME33G-AGA	4084	4410	4902	84	24	29	465
	ME33H-AGA	4130	4460	4957	90	24	29	475
	ME33J-AGA	4177	4510	5013	96	24	29	485

Veneer species must be noted on each line item

Removable access panel with standard black unfinished back.

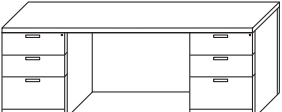
	ME34D-AHA	4099	4427	4920	66	25	29	488
	ME34E-AHA	4135	4466	4963	72	25	29	501
	ME34F-AHA	4444	4799	5334	78	25	29	515
	ME34G-AHA	4485	4844	5384	84	25	29	527
	ME34H-AHA	4624	4994	5550	90	25	29	541
	ME34J-AHA	4666	5038	5600	96	25	29	555

Veneer species must be noted on each line item

Finished, fixed back panel.

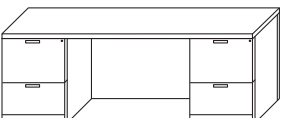
	ME31D-BGB	3811	4116	4574	66	24	29	437
	ME31E-BGB	3914	4226	4698	72	24	29	447
	ME31F-BGB	4043	4365	4852	78	24	29	457
	ME31G-BGB	4084	4410	4902	84	24	29	465
	ME31H-BGB	4130	4460	4957	90	24	29	475
	ME31J-BGB	4177	4510	5013	96	24	29	485

Veneer species must be noted on each line item

Removable access panel with standard black unfinished back.

Veneer species must be noted on each line item

<u>Veneer Grade 1</u>	<u>Veneer Grade 2</u>	<u>Veneer Grade 3</u>
Cherry	Rift Oak	Anigre
Maple	Sapele	
Ligno-Grain		
Walnut		

# HBF Mercer Casegoods - Credenzas

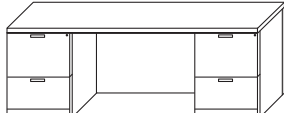
Style Number	List Price			Dimensions			Weight	
	Veneer 1	Veneer 2	Veneer 3	OW	OD	OH		
<b>Double Pedestal Credenza</b>								
	ME32D-BGB	3811	4116	4574	66	24	29	437
	ME32E-BGB	3914	4226	4698	72	24	29	447
	ME32F-BGB	4043	4365	4852	78	24	29	457
	ME32G-BGB	4084	4410	4902	84	24	29	465
	ME32H-BGB	4130	4460	4957	90	24	29	475
	ME32J-BGB	4177	4510	5013	96	24	29	485

Veneer species must be noted on each line item  
Removable access panel with standard black unfinished back.

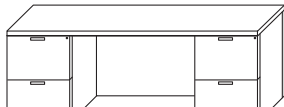
	ME33D-BGB	3811	4116	4574	66	24	29	437
	ME33E-BGB	3914	4226	4698	72	24	29	447
	ME33F-BGB	4043	4365	4852	78	24	29	457
	ME33G-BGB	4084	4410	4902	84	24	29	465
	ME33H-BGB	4130	4460	4957	90	24	29	475
	ME33J-BGB	4177	4510	5013	96	24	29	485

Veneer species must be noted on each line item  
Removable access panel with standard black unfinished back.

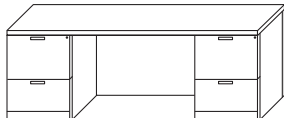
	ME34D-BHB	4099	4427	4920	66	25	29	488
	ME34E-BHB	4135	4466	4963	72	25	29	501
	ME34F-BHB	4444	4799	5334	78	25	29	515
	ME34G-BHB	4485	4844	5384	84	25	29	527
	ME34H-BHB	4624	4994	5550	90	25	29	541
	ME34J-BHB	4666	5038	5600	96	25	29	555

Veneer species must be noted on each line item  
Finished, fixed back panel.

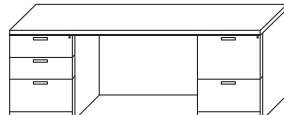
	ME31D-AGB	3811	4116	4574	66	24	29	437
	ME31E-AGB	3914	4226	4698	72	24	29	447
	ME31F-AGB	4043	4365	4852	78	24	29	457
	ME31G-AGB	4084	4410	4902	84	24	29	465
	ME31H-AGB	4130	4460	4957	90	24	29	475
	ME31J-AGB	4177	4510	5013	96	24	29	485

Veneer species must be noted on each line item  
Removable access panel with standard black unfinished back.

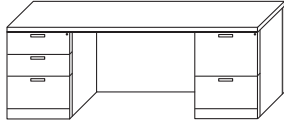
	ME32D-AGB	3811	4116	4574	66	24	29	437
	ME32E-AGB	3914	4226	4698	72	24	29	447
	ME32F-AGB	4043	4365	4852	78	24	29	457
	ME32G-AGB	4084	4410	4902	84	24	29	465
	ME32H-AGB	4130	4460	4957	90	24	29	475
	ME32J-AGB	4177	4510	5013	96	24	29	485

Veneer species must be noted on each line item  
Removable access panel with standard black unfinished back.

**Veneer species must be noted on each line item**

<u>Veneer Grade 1</u>	<u>Veneer Grade 2</u>	<u>Veneer Grade 3</u>
Cherry	Rift Oak	Anigre
Maple	Sapele	
Ligno-Grain		
Walnut		

# HBF Mercer Casegoods - Credenzas

Style Number	List Price			Dimensions			Weight
	Veneer 1	Veneer 2	Veneer 3	OW	OD	OH	

## Double Pedestal Credenza

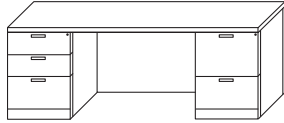

ME33D-AGB	3811	4116	4574	66	24	29	437
ME33E-AGB	3914	4226	4698	72	24	29	447
ME33F-AGB	4043	4365	4852	78	24	29	457
ME33G-AGB	4084	4410	4902	84	24	29	465
ME33H-AGB	4130	4460	4957	90	24	29	475
ME33J-AGB	4177	4510	5013	96	24	29	485

Veneer species must be noted on each line item

Removable access panel with standard black unfinished back.

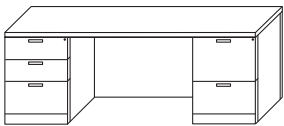

ME34D-AHB	4099	4427	4920	66	25	29	488
ME34E-AHB	4135	4466	4963	72	25	29	501
ME34F-AHB	4444	4799	5334	78	25	29	515
ME34G-AHB	4485	4844	5384	84	25	29	527
ME34H-AHB	4624	4994	5550	90	25	29	541
ME34J-AHB	4666	5038	5600	96	25	29	555

Veneer species must be noted on each line item

Finished, fixed back panel.

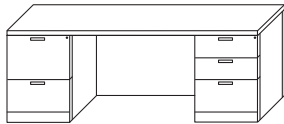

ME31D-BGA	3811	4116	4574	66	24	29	437
ME31E-BGA	3914	4226	4698	72	24	29	447
ME31F-BGA	4043	4365	4852	78	24	29	457
ME31G-BGA	4084	4410	4902	84	24	29	465
ME31H-BGA	4130	4460	4957	90	24	29	475
ME31J-BGA	4177	4510	5013	96	24	29	485

Veneer species must be noted on each line item

Removable access panel with standard black unfinished back.

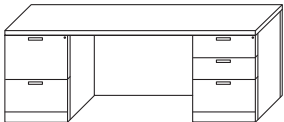

ME32D-BGA	3811	4116	4574	66	24	29	437
ME32E-BGA	3914	4226	4698	72	24	29	447
ME32F-BGA	4043	4365	4852	78	24	29	457
ME32G-BGA	4084	4410	4902	84	24	29	465
ME32H-BGA	4130	4460	4957	90	24	29	475
ME32J-BGA	4177	4510	5013	96	24	29	485

Veneer species must be noted on each line item

Removable access panel with standard black unfinished back.

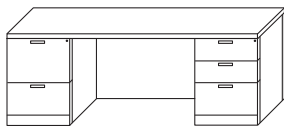

ME33D-BGA	3811	4116	4574	66	24	29	437
ME33E-BGA	3914	4226	4698	72	24	29	447
ME33F-BGA	4043	4365	4852	78	24	29	457
ME33G-BGA	4084	4410	4902	84	24	29	465
ME33H-BGA	4130	4460	4957	90	24	29	475
ME33J-BGA	4177	4510	5013	96	24	29	485

Veneer species must be noted on each line item

Removable access panel with standard black unfinished back.

Veneer species must be noted on each line item

Veneer Grade 1	Veneer Grade 2	Veneer Grade 3
Cherry	Rift Oak	Anigre
Maple	Sapele	
Ligno-Grain		
Walnut		

# HBF Mercer Casegoods - Credenzas

Style Number	List Price			Dimensions			Weight
	Veneer 1	Veneer 2	Veneer 3	OW	OD	OH	

## Double Pedestal Credenza

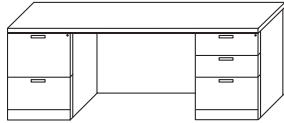

ME34D-BHA	4099	4427	4920	66	25	29	488
ME34E-BHA	4135	4466	4963	72	25	29	501
ME34F-BHA	4444	4799	5334	78	25	29	515
ME34G-BHA	4485	4844	5384	84	25	29	527
ME34H-BHA	4624	4994	5550	90	25	29	541
ME34J-BHA	4666	5038	5600	96	25	29	555

Veneer species must be noted on each line item

Finished, fixed back panel.

## Single Pedestal Credenza

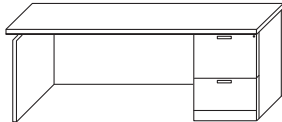

ME31D-LGB	2787	3009	3344	66	24	29	326
ME31E-LGB	2828	3053	3394	72	24	29	336
ME31F-LGB	2957	3192	3548	78	24	29	346
ME31G-LGB	3322	3588	3987	84	24	29	372
ME31H-LGB	3368	3638	4042	90	24	29	390
ME31J-LGB	3415	3688	4098	96	24	29	408

Veneer species must be noted on each line item

Removable access panel with standard black unfinished back.

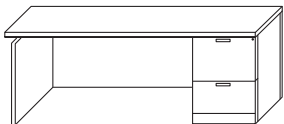

ME32D-LGB	2787	3009	3344	66	24	29	326
ME32E-LGB	2828	3053	3394	72	24	29	336
ME32F-LGB	2957	3192	3548	78	24	29	346
ME32G-LGB	3322	3588	3987	84	24	29	372
ME32H-LGB	3368	3638	4042	90	24	29	390
ME32J-LGB	3415	3688	4098	96	24	29	408

Veneer species must be noted on each line item

Removable access panel with standard black unfinished back.

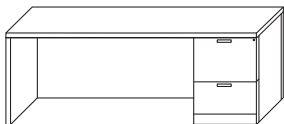

ME33D-KGB	2972	3209	3566	66	24	29	326
ME33E-KGB	3013	3253	3616	72	24	29	336
ME33F-KGB	3142	3392	3770	78	24	29	346
ME33G-KGB	3507	3788	4209	84	24	29	372
ME33H-KGB	3553	3838	4264	90	24	29	390
ME33J-KGB	3600	3888	4320	96	24	29	408

Veneer species must be noted on each line item

Removable access panel with standard black unfinished back.

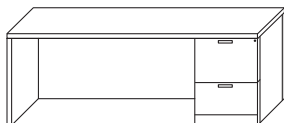

ME34D-KHB	3198	3454	3838	66	25	29	377
ME34E-KHB	3234	3493	3881	72	25	29	390
ME34F-KHB	3543	3826	4252	78	25	29	404
ME34G-KHB	3584	3871	4302	84	25	29	434
ME34H-KHB	3723	4021	4468	90	25	29	456
ME34J-KHB	3765	4065	4518	96	25	29	478

Veneer species must be noted on each line item

Finished, fixed back panel.

Veneer species must be noted on each line item

Veneer Grade 1	Veneer Grade 2	Veneer Grade 3
Cherry	Rift Oak	Anigre
Maple	Sapele	
Ligno-Grain		
Walnut		



# HBF Mercer Casegoods - Credenzas

Style Number	List Price			Dimensions			Weight
	Veneer 1	Veneer 2	Veneer 3	OW	OD	OH	

## Single Pedestal Credenza

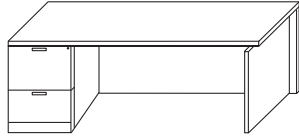

ME31D-BGL	2787	3009	3344	66	24	29	326
ME31E-BGL	2828	3053	3394	72	24	29	336
ME31F-BGL	2957	3192	3548	78	24	29	346
ME31G-BGL	3322	3588	3987	84	24	29	372
ME31H-BGL	3368	3638	4042	90	24	29	390
ME31J-BGL	3415	3688	4098	96	24	29	408

Veneer species must be noted on each line item

Removable access panel with standard black unfinished back.

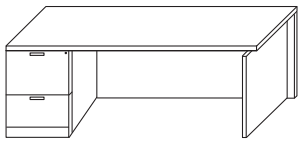

ME32D-BGL	2787	3009	3344	66	24	29	326
ME32E-BGL	2828	3053	3394	72	24	29	336
ME32F-BGL	2957	3192	3548	78	24	29	346
ME32G-BGL	3322	3588	3987	84	24	29	372
ME32H-BGL	3368	3638	4042	90	24	29	390
ME32J-BGL	3415	3688	4098	96	24	29	408

Veneer species must be noted on each line item

Removable access panel with standard black unfinished back.

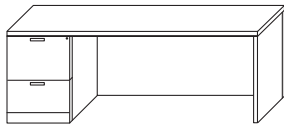

ME33D-BGK	2972	3209	3566	66	24	29	326
ME33E-BGK	3013	3253	3616	72	24	29	336
ME33F-BGK	3142	3392	3770	78	24	29	346
ME33G-BGK	3507	3788	4209	84	24	29	372
ME33H-BGK	3553	3838	4264	90	24	29	390
ME33J-BGK	3600	3888	4320	96	24	29	408

Veneer species must be noted on each line item

Removable access panel with standard black unfinished back.

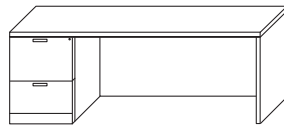

ME34D-BHK	3198	3454	3838	66	25	29	377
ME34E-BHK	3234	3493	3881	72	25	29	390
ME34F-BHK	3543	3826	4252	78	25	29	404
ME34G-BHK	3584	3871	4302	84	25	29	434
ME34H-BHK	3723	4021	4468	90	25	29	456
ME34J-BHK	3765	4065	4518	96	25	29	478

Veneer species must be noted on each line item

Finished, fixed back panel.

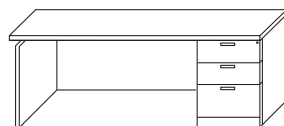

ME31D-LGA	2787	3009	3344	66	24	29	326
ME31E-LGA	2828	3053	3394	72	24	29	336
ME31F-LGA	2957	3192	3548	78	24	29	346
ME31G-LGA	3322	3588	3987	84	24	29	372
ME31H-LGA	3368	3638	4042	90	24	29	390
ME31J-LGA	3415	3688	4098	96	24	29	408

Veneer species must be noted on each line item

Removable access panel with standard black unfinished back.

Veneer species must be noted on each line item

Veneer Grade 1	Veneer Grade 2	Veneer Grade 3
Cherry	Rift Oak	Anigre
Maple	Sapele	
Ligno-Grain		
Walnut		

# HBF Mercer Casegoods - Credenzas

Style Number	List Price			Dimensions			Weight
	Veneer 1	Veneer 2	Veneer 3	OW	OD	OH	

## Single Pedestal Credenza

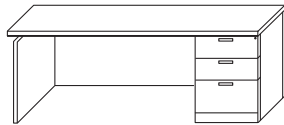

ME32D-LGA	2787	3009	3344	66	24	29	326
ME32E-LGA	2828	3053	3394	72	24	29	336
ME32F-LGA	2957	3192	3548	78	24	29	346
ME32G-LGA	3322	3588	3987	84	24	29	372
ME32H-LGA	3368	3638	4042	90	24	29	390
ME32J-LGA	3415	3688	4098	96	24	29	408

Veneer species must be noted on each line item

Removable access panel with standard black unfinished back.

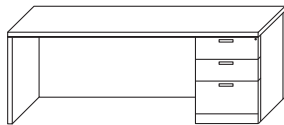

ME33D-KGA	2972	3209	3566	66	24	29	326
ME33E-KGA	3013	3253	3616	72	24	29	336
ME33F-KGA	3142	3392	3770	78	24	29	346
ME33G-KGA	3507	3788	4209	84	24	29	372
ME33H-KGA	3553	3838	4264	90	24	29	390
ME33J-KGA	3600	3888	4320	96	24	29	408

Veneer species must be noted on each line item

Removable access panel with standard black unfinished back.

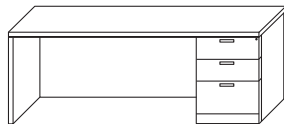

ME34D-KHA	3198	3454	3838	66	25	29	377
ME34E-KHA	3234	3493	3881	72	25	29	390
ME34F-KHA	3543	3826	4252	78	25	29	404
ME34G-KHA	3584	3871	4302	84	25	29	434
ME34H-KHA	3723	4021	4468	90	25	29	456
ME34J-KHA	3765	4065	4518	96	25	29	478

Veneer species must be noted on each line item

Finished, fixed back panel.

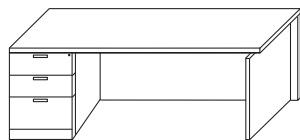

ME31D-AGL	2787	3009	3344	66	24	29	326
ME31E-AGL	2828	3053	3394	72	24	29	336
ME31F-AGL	2957	3192	3548	78	24	29	346
ME31G-AGL	3322	3588	3987	84	24	29	372
ME31H-AGL	3368	3638	4042	90	24	29	390
ME31J-AGL	3415	3688	4098	96	24	29	408

Veneer species must be noted on each line item

Removable access panel with standard black unfinished back.

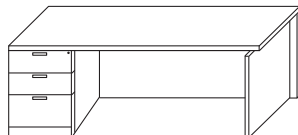

ME32D-AGL	2787	3009	3344	66	24	29	326
ME32E-AGL	2828	3053	3394	72	24	29	336
ME32F-AGL	2957	3192	3548	78	24	29	346
ME32G-AGL	3322	3588	3987	84	24	29	372
ME32H-AGL	3368	3638	4042	90	24	29	390
ME32J-AGL	3415	3688	4098	96	24	29	408

Veneer species must be noted on each line item

Removable access panel with standard black unfinished back.

### Veneer species must be noted on each line item

Veneer Grade 1	Veneer Grade 2	Veneer Grade 3
Cherry	Rift Oak	Anigre
Maple	Sapele	
Ligno-Grain		
Walnut		

# HBF Mercer Casegoods - Credenzas

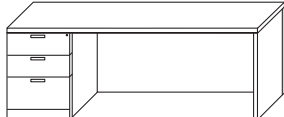
Style Number	List Price			Dimensions			Weight	
	Veneer 1	Veneer 2	Veneer 3	OW	OD	OH		
<b>Single Pedestal Credenza</b>								
	ME33D-AGK	2972	3209	3566	66	24	29	326
	ME33E-AGK	3013	3253	3616	72	24	29	336
	ME33F-AGK	3142	3392	3770	78	24	29	346
	ME33G-AGK	3507	3788	4209	84	24	29	372
	ME33H-AGK	3553	3838	4264	90	24	29	390
	ME33J-AGK	3600	3888	4320	96	24	29	408

Veneer species must be noted on each line item  
Removable access panel with standard black unfinished back.

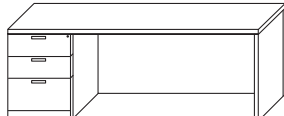
	ME34D-AHK	3198	3454	3838	66	25	29	377
	ME34E-AHK	3234	3493	3881	72	25	29	390
	ME34F-AHK	3543	3826	4252	78	25	29	404
	ME34G-AHK	3584	3871	4302	84	25	29	434
	ME34H-AHK	3723	4021	4468	90	25	29	456
	ME34J-AHK	3765	4065	4518	96	25	29	478

Veneer species must be noted on each line item  
Finished, fixed back panel.

## Double Pedestal Credenza, Center Doors

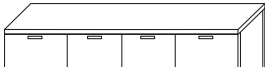
	ME31D-BEB	4779	5161	5736	66	24	29	400
	ME32D-BEB	4779	5161	5736	66	24	29	400
	ME33D-BEB	4779	5161	5736	66	24	29	400
	ME34D-BEB	5402	5834	6484	66	25	29	400

Veneer species must be noted on each line item  
Two-door cabinet is 30" OW, one adjustable shelf.

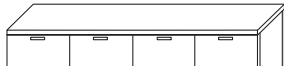
	ME31E-BFB	4846	5233	5816	72	24	29	415
	ME32E-BFB	4846	5233	5816	72	24	29	415
	ME33E-BFB	4846	5233	5816	72	24	29	415
	ME34E-BFB	5464	5901	6557	72	25	29	415

Veneer species must be noted on each line item  
Two-door cabinet is 36" OW, one adjustable shelf.

### Veneer species must be noted on each line item

Veneer Grade 1	Veneer Grade 2	Veneer Grade 3
Cherry	Rift Oak	Anigre
Maple	Sapele	
Ligno-Grain		
Walnut		

# HBF Mercer Casegoods - Credenzas

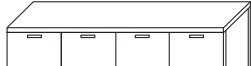
Style Number	List Price			Dimensions			Weight	
	Veneer 1	Veneer 2	Veneer 3	OW	OD	OH		
<b>Credenza, Doors</b>								
	ME31C-EE	3487	3765	4185	60	24	29	423
	ME32C-EE	3487	3765	4185	60	24	29	423
	ME33C-EE	3487	3765	4185	60	24	29	423
	ME34C-EE	4115	4444	4939	60	25	29	423

Veneer species must be noted on each line item

Two-door cabinet is 30" OW, one adjustable shelf per cabinet.

	ME31E-FF	3621	3910	4344	72	24	29	453
	ME32E-FF	3621	3910	4344	72	24	29	453
	ME33E-FF	3621	3910	4344	72	24	29	453
	ME34E-FF	4239	4578	5085	72	25	29	453

Veneer species must be noted on each line item

Two-door cabinet is 36" OW, one adjustable shelf per cabinet.

Veneer species must be noted on each line item

Veneer Grade 1	Veneer Grade 2	Veneer Grade 3
Cherry	Rift Oak	Anigre
Maple	Sapele	
Ligno-Grain		
Walnut		

# HBF Mercer Casegoods - Credenzas

## Credenzas - Other Configurations

HBF Mercer credenzas are offered in many different sizes and pedestal configurations for maximum flexibility. For ease in specification, use the style number creation system described below. This system allows you to select a variety of credenza widths and place components in any configuration. Credenza pricing is calculated by totaling the individual prices of all components and the credenza top price. *Several commonly used credenzas are listed on the previous pages for your convenience.*

### Style Number Creation System

#### Example Credenza

<u>Product Code</u>	<u>Width Code</u>	=	<u>Component Configuration</u>
31 ↓	H ↓		ABGK ↓
<b>31 Credenza - Front finished</b>	M 18"		<b>A Box/Box/File 18"</b>
32 Credenza - Front and one end finished	N 24"		<b>B File/File 18"</b>
33 Credenza - Front and both ends finished	P 30"		C Lateral File 30"
34 Credenza - Front, back and both ends finished	R 36"		D Lateral File 36"
	S 42"		M Open Lateral File 30"
	A 48"		N Open Lateral File 36"
	B 54"		U Single Door 18"
	C 60"		E Double Door 30"
	D 66"		F Double Door 36"
	E 72"		<b>G Removable Access Panel</b>
	F 78"		H Finished Modesty Panel
	G 84"		J Open - No Modesty Panel
	<b>H 90"</b>		<b>K End Panel - Finished</b>
	J 96"		L Recessed End Panel Unfinished
	K 102"		
	L 108"		
	T 114"		
	U 120"		

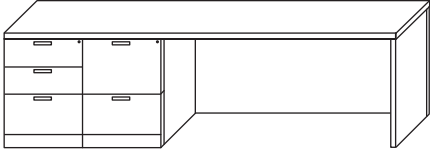

OW 90"  
OD 24"  
OH 29"

### Style Number Descriptions

**Product Code:** Denotes the product as a credenza and also specifies the number of credenza finished sides.

**31** - 1 Side: Only the front (user side) is finished. These units have unfinished backs.

**32** - 2 Sides: Front and one end is finished. Credenza back is unfinished.

**33** - 3 Sides: Front and both ends are finished. Credenza back is unfinished.

**34** - 4 Sides: Front, back and both ends are finished. Credenza back is finished.

Mercer: Band each finished side, no overhang.



Finished - 1 Side (**31**)

Actual Depth = 24"

Unfinished Back



Finished - 2 Sides (**32**)

Actual Depth = 24"

Unfinished Back



Finished - 3 Sides (**33**)

Actual Depth = 24"

Unfinished Back



Finished - 4 Sides (**34**)

Actual Depth = 24 3/4"

Note: Additional 3/4" added to depth for Product Code 34 Finished Back

**Width Code:** Denotes the actual width of the credenza.

**Note:** Credenza pedestal back recessed 4" to allow for wall access and wire management.

# HBF Mercer Casegoods - Credenzas

## Credenzas - Other Configurations

### Credenza Tops, Descriptions and Pricing

All available sizes of Mercer credenza tops are listed below. To calculate the price of a credenza, total the individual prices of all components and the credenza top price. Individual component prices are contained in the lists below. All credenza tops with an edge detail on the front (user side) profile are Product Code 31. Credenza tops with edge details on the front (user side) and back profiles, Product Code 34, include a finished back panel. Pricing examples are calculated on the following page.

Credenza Top Width	Width Code	Credenza Top List Price			Weight	Product Code 34 Credenzas			Weight
		Product Code 31, 32, 33 Credenzas	Veneer 1	Veneer 2		Veneer 3	Veneer 1	Veneer 2	
18"	M	345	373	414	35	891	962	1069	62
24"	N	381	412	457	45	927	1001	1112	75
30"	P	479	517	575	55	1020	1101	1224	88
36"	R	515	556	618	65	1066	1151	1279	101
42"	S	561	606	674	78	1107	1196	1329	114
48"	A	603	651	723	85	1148	1240	1378	127
54"	B	850	918	1020	95	1473	1591	1767	140
60"	C	881	951	1057	105	1509	1630	1811	153
66"	D	922	996	1106	115	1545	1669	1854	166
72"	E	963	1040	1156	125	1581	1708	1897	179
78"	F	1092	1179	1310	135	1890	2041	2268	193
84"	G	1133	1224	1360	143	1931	2086	2318	205
90"	H	1179	1274	1415	153	2070	2236	2484	219
96"	J	1226	1324	1471	163	2112	2280	2534	233
102"	K	1246	1346	1496	173	2312	2497	2775	248
108"	L	1267	1368	1520	183	2333	2520	2800	263
114"	T	1334	1441	1601	193	2467	2664	2960	278
120"	U	1354	1463	1625	203	2493	2692	2991	293

### Credenza Components, Descriptions and Pricing

**Component Configuration:** Denotes the pedestal/component configuration when viewing the credenza from the user side and reading left to right. When selecting from the following components please ensure the width of credenza top specified will accommodate all selected components. Kneespaces will account for the difference between credenza overall width and the total width of all specified components coded A, B, C, D, U, E and F. Minimum kneespace width should be at least 24".

Casegood Components	Component Code	OW	List Price			Weight
			Veneer 1	Veneer 2	Veneer 3	
Box/box/file	A	18"	1277	1379	1533	125
File/file	B	18"	1277	1379	1533	125
Lateral file	C	30"	1535	1657	1842	140
Lateral file	D	36"	1622	1752	1947	140
Lat/Open	M	30"	1380	1491	1656	85
Lat/Open	N	36"	1468	1585	1761	95
Single door cabinet*	U	18"	1045	1129	1255	95
Double door cabinet	E	30"	1303	1407	1564	95
Double door cabinet	F	36"	1329	1435	1594	95
Removable access panel	G	6" - 30"	335	362	402	24
		31" - 60"	397	428	476	42
		61" (2 panels)	721	779	865	60

*This kneespace panel is completely removable to allow for wall access. It has a standard black unfinished back and is finished inside. The width will vary based upon credenza top width selected and the width of all specified components. The removable access panel price is based on its width. Only specified for Product Code 31, 32, 33.*

Finished modesty panel	H	varies	No Charge (Product Code 34)			N/A
<i>The panel is fixed and is finished on both sides. This kneespace panel is standard on all kneespace credenzas with edge details on the front and back profiles (Product Code 34). Its size will be automatically selected. There is no charge for a finished modesty panel as its cost is contained in the pricing above for credenza tops with front and back edge details. Only specified for Product Code 34.</i>						
Open back	J	varies	No Charge			N/A
<i>No removable access panel or finished modesty panel will be placed in the back of the kneespace.</i>						
Finished end panel	K	N/A	\$376	406	451	29
<i>This finished end panel is placed at the end of a kneespace on the left or right side of a credenza. The panel is finished on both sides.</i>						
Recessed end panel	L	N/A	\$191	206	229	29
<i>This recessed end panel is placed at the end of a kneespace. It should only be used on credenzas specified with a bridge or return including a removable access panel. This panel will be recessed 4" for wire management. This recess will create a flush joint with the bridge or return's removable access panel. The outside has a standard black, unfinished back.</i>						

**Note:** \*1. Specify left hinge or right hinge on single door cabinets.

# HBF Mercer Casegoods - Credenzas

## Credenzas Pricing Examples

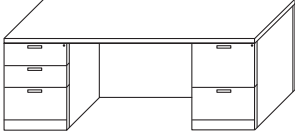
	Component Description	Width Code	Component Code	List Price	
<b>ME33E-AGB</b> 	72" Top	E		\$1156	
	Box/box/file		A	\$1533	
	36" Removable access panel - unfinished back		G	\$476	
	File/file		B	\$1533	
				Total	\$4698

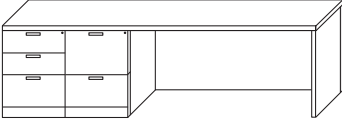
<b>ME33H-ABGK</b> 	90" Top	H		\$1274	
	Box/box/file		A	\$1379	
	File/file		B	\$1379	
	54" Removable access panel - unfinished back		G	\$428	
	Finished end panel		K	\$406	
			Total	\$4866	Veneer Grade 2

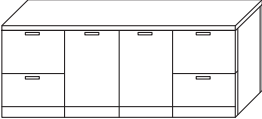
<b>ME34D-BEB</b> 	66" Top (finished back panel)	D		\$1545	
	File/file		B	\$1277	
	Double door cabinet - 30"		E	\$1303	
	File/file		B	\$1277	
			Total	\$5402	Veneer Grade 1

**Veneer species must be noted on each line item**

<u>Veneer Grade 1</u>	<u>Veneer Grade 2</u>	<u>Veneer Grade 3</u>
Cherry	Rift Oak	Anigre
Maple	Sapele	
Ligno-Grain		
Walnut		

# HBF Mercer Casegoods - Returns

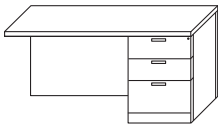
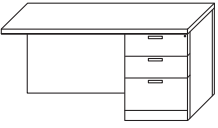
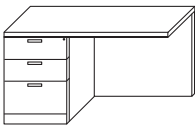
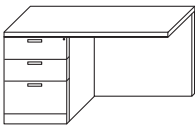
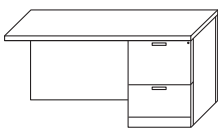
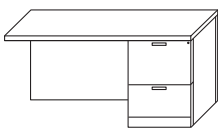
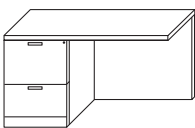
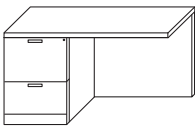
	Style Number	List Price			Dimensions			Weight
		Veneer 1	Veneer 2	Veneer 3	OW	OD	OH	
<b>Returns with Pedestals</b>								
	ME44S-HA	2384	2575	2861	42	24	29	254
	ME44A-HA	2426	2620	2911	48	24	29	266
	ME44B-HA	2750	2970	3300	54	24	29	278
	<b>Veneer species must be noted on each line item</b> Finished, fixed modesty panel.							
	ME43S-GA	2173	2347	2608	42	24	29	249
	ME43A-GA	2215	2392	2657	48	24	29	262
	ME43B-GA	2524	2725	3028	54	24	29	274
	<b>Veneer species must be noted on each line item</b> Removable access panel with unfinished back.							
	ME44S-AH	2384	2575	2861	42	24	29	254
	ME44A-AH	2426	2620	2911	48	24	29	266
	ME44B-AH	2750	2970	3300	54	24	29	278
	<b>Veneer species must be noted on each line item</b> Finished, fixed modesty panel.							
	ME43S-AG	2173	2347	2608	42	24	29	249
	ME43A-AG	2215	2392	2657	48	24	29	262
	ME43B-AG	2524	2725	3028	54	24	29	274
	<b>Veneer species must be noted on each line item</b> Removable access panel with unfinished back.							
	ME44S-HB	2384	2575	2861	42	24	29	254
	ME44A-HB	2426	2620	2911	48	24	29	266
	ME44B-HB	2750	2970	3300	54	24	29	278
	<b>Veneer species must be noted on each line item</b> Finished, fixed modesty panel.							
	ME43S-GB	2173	2347	2608	42	24	29	249
	ME43A-GB	2215	2392	2657	48	24	29	262
	ME43B-GB	2524	2725	3028	54	24	29	274
	<b>Veneer species must be noted on each line item</b> Removable access panel with unfinished back.							
	ME44S-BH	2384	2575	2861	42	24	29	254
	ME44A-BH	2426	2620	2911	48	24	29	266
	ME44B-BH	2750	2970	3300	54	24	29	278
	<b>Veneer species must be noted on each line item</b> Finished, fixed modesty panel.							
	ME43S-BG	2173	2347	2608	42	24	29	249
	ME43A-BG	2215	2392	2657	48	24	29	262
	ME43B-BG	2524	2725	3028	54	24	29	274
	<b>Veneer species must be noted on each line item</b> Removable access panel with unfinished back.							
<b>Veneer species must be noted on each line item</b>								
<b><u>Veneer Grade 1</u></b>		<b><u>Veneer Grade 2</u></b>		<b><u>Veneer Grade 3</u></b>				
Cherry		Rift Oak		Anigre				
Maple		Sapele						
Ligno-Grain								
Walnut								

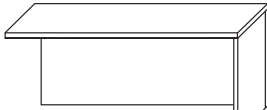

# HBF Mercer Casegoods - Returns

Style Number	List Price			Dimensions			Weight	
	Veneer 1	Veneer 2	Veneer 3	OW	OD	OH		
	ME44C-HK	1885	2036	2262	60	24	29	282
	ME44D-HK	1921	2075	2305	66	24	29	296
	ME44E-HK	1957	2114	2348	72	24	29	309
	ME44F-HK	2266	2447	2719	78	24	29	322
	ME44G-HK	2307	2492	2769	84	24	29	335

Veneer species must be noted on each line item

Finished, fixed modesty panel.

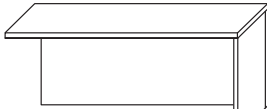
	ME43C-GK	1653	1785	1984	60	24	29	282
	ME43D-GK	2019	2180	2423	66	24	29	296
	ME43E-GK	2060	2225	2472	72	24	29	309
	ME43F-GK	2189	2364	2627	78	24	29	322
	ME43G-GK	2230	2408	2676	84	24	29	335

Veneer species must be noted on each line item

Removable access panel with unfinished back.

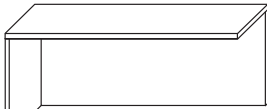
	ME44C-KH	1885	2036	2262	60	24	29	282
	ME44D-KH	1921	2075	2305	66	24	29	296
	ME44E-KH	1957	2114	2348	72	24	29	309
	ME44F-KH	2266	2447	2719	78	24	29	322
	ME44G-KH	2307	2492	2769	84	24	29	335

Veneer species must be noted on each line item

Finished, fixed modesty panel.

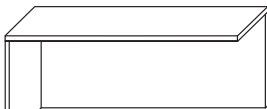
	ME43C-KG	1653	1785	1984	60	24	29	282
	ME43D-KG	2019	2180	2423	66	24	29	296
	ME43E-KG	2060	2225	2472	72	24	29	309
	ME43F-KG	2189	2364	2627	78	24	29	322
	ME43G-KG	2230	2408	2676	84	24	29	335

Veneer species must be noted on each line item

Removable access panel with unfinished back.

Veneer species must be noted on each line item

<u>Veneer Grade 1</u>	<u>Veneer Grade 2</u>	<u>Veneer Grade 3</u>
Cherry	Rift Oak	Anigre
Maple	Sapele	
Ligno-Grain		
Walnut		

# HBF Mercer Casegoods - Returns

## Returns - Other Configurations

HBF Mercer returns are offered in many different sizes and pedestal configurations for maximum flexibility. For ease in specification, use the style number creation system described below. This system allows you to select a variety of return widths and place components in any configuration. Return pricing is calculated by totaling the individual prices of all components and the return top price. *Several commonly used returns are listed on the previous pages for your convenience.*

### Style Number Creation System

#### Example Return

Product Code	Width Code	=	Component Configuration
43 ↓	H ↓		ABG ↓
<b>43 Return - Front and one end finished</b> 44 Return - Front, back and one end finished	M 18" N 24" P 30" R 36" S 42" A 48" B 54" C 60" D 66" E 72" F 78" G 84" <b>H 90"</b> J 96" K 102" L 108" T 114" U 120"		<b>A Box/Box/File 18"</b> <b>B File/File 18"</b> C Lateral File 30" D Lateral File 36" M Open Lateral File 30" N Open Lateral File 36" U Single Door 18" E Double Door 30" F Double Door 36" <b>G Removable Access Panel</b> H Finished Modesty Panel J Open - No Modesty Panel K End Panel - Finished L Recessed End Panel Unfinished

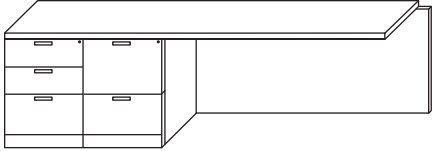

OW 90"  
OD 24"  
OH 29"

### Style Number Descriptions

**Product Code:** Denotes the product as a return and also specifies the number of return finished sides.

**43** - 2 Sides: Front and one end finished. Return back is unfinished.

**44** - 3 Sides: Front, back and one end finished. Return back is finished.



Finished - 2 Sides (**43**)

Actual Depth = 24"

Unfinished Back



Finished - 3 Sides (**44**)

Actual Depth = 24 3/4"

Finished Back

**Width Code:** Denotes the actual width of the return.

**Note:** Return pedestal back recessed 4" to allow for wall access and wire management.

# HBF Mercer Casegoods - Returns

## Returns - Other Configurations

### Return Tops, Descriptions and Pricing

All available sizes of Mercer return tops are listed below. To calculate the price of a return, total the individual prices of all components and the return top price. Individual component prices are contained in the lists below. All return tops with Product Code 43 have an unfinished back. Return tops with a Product Code 44, *include a finished back panel.*

Return Top Width	Width Code	Return Top List Price			Weight	Product Code 44 Returns			Weight
		Product Code 43 Returns				Product Code 44 Returns			
		Veneer 1	Veneer 2	Veneer 3		Veneer 1	Veneer 2	Veneer 3	
18"	M	345	373	414	35	891	962	1069	62
24"	N	381	412	457	45	927	1001	1112	75
30"	P	479	517	575	55	1020	1101	1224	88
36"	R	515	556	618	65	1066	1151	1279	101
42"	S	561	606	674	78	1107	1196	1329	114
48"	A	603	651	723	85	1148	1240	1378	127
54"	B	850	918	1020	95	1473	1591	1767	140
60"	C	881	951	1057	105	1509	1630	1811	153
66"	D	922	996	1106	115	1545	1669	1854	166
72"	E	963	1040	1156	125	1581	1708	1897	179
78"	F	1092	1179	1310	135	1890	2041	2268	193
84"	G	1133	1224	1360	143	1931	2086	2318	205
90"	H	1179	1274	1415	153	2070	2236	2484	219
96"	J	1226	1324	1471	163	2112	2280	2534	233
102"	K	1246	1346	1496	173	2312	2497	2775	248
108"	L	1267	1368	1520	183	2333	2520	2800	263
114"	T	1334	1441	1601	193	2467	2664	2960	278
120"	U	1354	1463	1625	203	2493	2692	2991	293

### Return Components, Descriptions and Pricing

**Component Configuration:** Denotes the pedestal/component configuration when viewing the return from the user side and reading left to right. When selecting from the following components please ensure the width of return top specified will accommodate all selected components. Kneespaces will account for the difference between return overall width and the total width of all specified components coded A, B, C, D, U, E and F. Minimum kneespace width should be at least 24".

Casegood Components	Component Code	OW	List Price			Weight
			Veneer 1	Veneer 2	Veneer 3	
Box/box/file	A	18"	1277	1379	1533	125
File/file	B	18"	1277	1379	1533	125
Lateral file	C	30"	1535	1657	1842	140
Lateral file	D	36"	1622	1752	1947	140
Lat/Open	M	30"	1380	1491	1656	85
Lat/Open	N	36"	1468	1585	1761	95
Single door cabinet*	U	18"	1045	1129	1255	95
Double door cabinet	E	30"	1303	1407	1564	95
Double door cabinet	F	36"	1329	1435	1594	95
Removable access panel	G	6" - 30"	335	362	402	24
		31" - 60"	397	428	476	42
		61" (2 panels)	721	779	865	60

*This kneespace panel is completely removable to allow for wall access. It has a standard black unfinished back and is finished inside. The width will vary based upon return top width selected and the width of all specified components. The removable access panel price is based on its width. Only specified for Product Code 31, 32, 33.*

Finished modesty panel	H	varies	No Charge (Product Code 44)			N/A
<i>The panel is fixed and is finished on both sides. This kneespace panel is standard on all kneespace return with edge details on the front and back profiles (Product Code 44). Its size will be automatically selected. There is no charge for a finished modesty panel as its cost is contained in the pricing above for return tops with front and back edge details. Only specified for Product Code 44.</i>						
Open back	J	varies	No Charge			N/A
<i>No removable access panel or finished modesty panel will be placed in the back of the kneespace.</i>						
Finished end panel	K	N/A	\$376	406	451	29
<i>This finished end panel is placed at the end of a kneespace on the left or right side of a return. The panel is finished on both sides.</i>						
Recessed end panel	L	N/A	\$191	206	229	29
<i>This recessed end panel is placed at the end of a kneespace. It should only be used on returns specified with a bridge or return including a removable access panel. This panel will be recessed 4" for wire management. This recess will create a flush joint with the bridge or return's removable access panel. The outside has a standard black, unfinished back.</i>						

**Note:** \*1. Specify left hinge or right hinge on single door cabinets.

# HBF Mercer Casegoods - Bridges, Corner Units

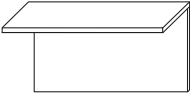
	Style Number	List Price			Dimensions			Weight
		Veneer 1	Veneer 2	Veneer 3	OW	OD	OH	
	ME52D	1128	1218	1353	24	24	29	111
	ME52E	1210	1307	1452	30	24	29	123
	ME52F	1251	1352	1502	36	24	29	135
	ME52A	1303	1407	1564	42	24	29	147
	ME52B	1334	1441	1601	48	24	29	159
	ME52C	1571	1696	1885	54	24	29	171

Veneer species must be noted on each line item

Finished, fixed modesty panel.

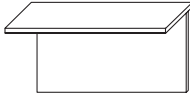
	ME51D	819	884	983	24	24	29	101
	ME51E	891	962	1069	30	24	29	113
	ME51F	942	1018	1131	36	24	29	125
	ME51A	994	1073	1193	42	24	29	137
	ME51B	1025	1107	1230	48	24	29	149
	ME51C	1334	1441	1601	54	24	29	161

Veneer species must be noted on each line item

Removable access panel; standard black, unfinished back.

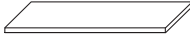
	ME50D	397	428	476	24	24		68
	ME50E	489	528	587	30	24		80
	ME50F	530	573	637	36	24		92
	ME50A	582	629	698	42	24		104
	ME50B	623	673	748	48	24		116
	ME50C	922	996	1106	54	24		128

Veneer species must be noted on each line item

Bridge top only.

24", 30" and 36" OW bridges are to be used only with corner units. Only bridges 42" OW and greater can be used with u-shaped configurations.

Veneer species must be noted on each line item

Veneer Grade 1	Veneer Grade 2	Veneer Grade 3
Cherry	Rift Oak	Anigre
Maple	Sapele	
Ligno-Grain		
Walnut		

# HBF Mercer Casegoods - Bridges, Corner Units

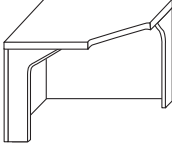
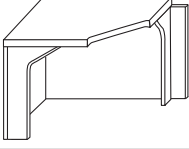
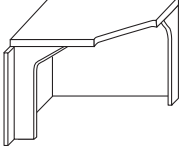
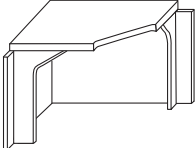
	Style Number	List Price			Dimensions			Weight
		Veneer 1	Veneer 2	Veneer 3	OW	OD	OH	
<b>Corner Units</b>								
	ME55A	2920	3154	3504	42	42	29	147
	ME55B	2982	3220	3578	48	48	29	159
<p><b>Veneer species must be noted on each line item</b>            Finished, fixed modesty panel left and right.</p>								
	ME56CL	2539	2742	3047	42	42	29	137
	ME56DL	2590	2798	3109	48	48	29	149
<p><b>Veneer species must be noted on each line item</b>            Finished, fixed modesty panel left, removable access panel right.</p>								
	ME56CR	2539	2742	3047	42	42	29	137
	ME56DR	2590	2798	3109	48	48	29	149
<p><b>Veneer species must be noted on each line item</b>            Removable access panel left, finished fixed modesty panel right.</p>								
	ME56A	2281	2464	2738	42	42	29	137
	ME56B	2333	2520	2800	48	48	29	149
<p><b>Veneer species must be noted on each line item</b>            Removable access panels left and right.</p>								

**Corner units used with bridges or returns only.**

24", 30" and 36" OW bridges are to be used only with corner units. Only bridges 42" OW and greater can be used with u-shaped configurations.

**Veneer species must be noted on each line item**

<u>Veneer Grade 1</u>	<u>Veneer Grade 2</u>	<u>Veneer Grade 3</u>
Cherry	Rift Oak	Anigre
Maple	Sapele	
Ligno-Grain		
Walnut		

# HBF Mercer Casegoods - Desk Extensions

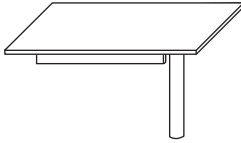
Style Number	List Price			Dimensions			Weight	
	Veneer 1	Veneer 2	Veneer 3	OW	OD	OH		
	ME20A	1694	1830	2033	48	30	29	156
	ME20B	1787	1930	2144	48	36	29	175
	ME20C	1736	1874	2083	54	30	29	174
	ME20D	1828	1975	2194	54	36	29	196
	ME20E	1787	1930	2144	60	30	29	191
	ME20F	1880	2030	2256	60	36	29	226
	ME20G	1828	1975	2194	66	30	29	206
	ME20H	1921	2075	2305	66	36	29	254
	ME20J	1880	2030	2256	72	30	29	222
	ME20K	1952	2108	2342	72	36	29	281

**Veneer species must be noted on each line item**

Rectangular, end forms joint with the profile of worksurface to which it is connected. Metal base support available in satin nickel or black powder coat finish, please specify on order.

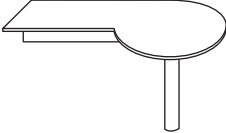
	ME22C	2436	2631	2923	54	30/36	29	196
	ME22D	2560	2764	3071	54	36/42	29	229
	ME22E	2498	2698	2997	60	30/36	29	226
	ME22F	2621	2831	3146	60	36/42	29	254
	ME22G	2560	2764	3071	66	30/36	29	254
	ME22H	2673	2887	3207	66	36/42	29	278
	ME22J	2621	2831	3146	72	30/36	29	281
	ME22K	2735	2953	3282	72	36/42	29	298

**Veneer species must be noted on each line item**

"P" left hand, end forms joint with the profile of worksurface to which it is connected. Metal base support available in satin nickel or black powder coat finish, please specify on order.

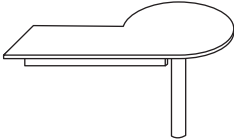
	ME23C	2436	2631	2923	54	30/36	29	196
	ME23D	2560	2764	3071	54	36/42	29	229
	ME23E	2498	2698	2997	60	30/36	29	226
	ME23F	2621	2831	3146	60	36/42	29	254
	ME23G	2560	2764	3071	66	30/36	29	254
	ME23H	2673	2887	3207	66	36/42	29	278
	ME23J	2621	2831	3146	72	30/36	29	281
	ME23K	2735	2953	3282	72	36/42	29	298

**Veneer species must be noted on each line item**

"P" right hand, end forms joint with the profile of worksurface to which it is connected. Metal base support available in satin nickel or black powder coat finish, please specify on order.

**Veneer species must be noted on each line item**

<u>Veneer Grade 1</u>	<u>Veneer Grade 2</u>	<u>Veneer Grade 3</u>
Cherry	Rift Oak	Anigre
Maple	Sapele	
Ligno-Grain		
Walnut		

# HBF Mercer Casegoods - Desk Extensions

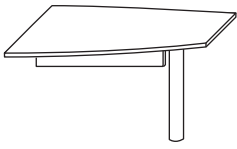
Style Number	List Price			Dimensions			Weight	
	Veneer 1	Veneer 2	Veneer 3	OW	OD	OH		
<b>Desk Extensions</b>								
	ME24A	2034	2197	2441	48	24/30	29	156
	ME24B	2127	2297	2552	48	30/36	29	175
	ME24C	2086	2253	2503	54	24/30	29	174
	ME24D	2168	2342	2602	54	30/36	29	196
	ME24E	2127	2297	2552	60	24/30	29	191
	ME24F	2209	2386	2651	60	30/36	29	226
	ME24G	2168	2342	2602	66	24/30	29	206
	ME24H	2251	2431	2701	66	30/36	29	254
	ME24J	2209	2386	2651	72	24/30	29	222
	ME24K	2292	2475	2750	72	30/36	29	281

**Veneer species must be noted on each line item**

Half boat, end forms joint with the profile of worksurface to which it is connected. Metal base support available in satin nickel or black powder coat finish, please specify on order.

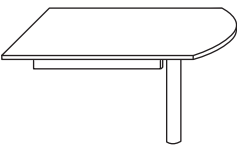
	ME25A	1942	2097	2330	48	30	29	156
	ME25B	2014	2175	2416	48	36	29	175
	ME25C	1983	2141	2379	54	30	29	174
	ME25D	2055	2219	2466	54	36	29	196
	ME25E	2014	2175	2416	60	30	29	191
	ME25F	2096	2264	2515	60	36	29	226
	ME25G	2055	2219	2466	66	30	29	206
	ME25H	2137	2308	2565	66	36	29	254
	ME25J	2096	2264	2515	72	30	29	222
	ME25K	2178	2353	2614	72	36	29	281

**Veneer species must be noted on each line item**

Arc'd end, end forms joint with the profile of worksurface to which it is connected. Metal base support available in satin nickel or black powder coat finish, please specify on order.

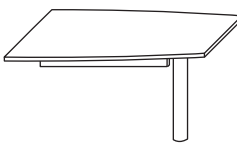
	ME26A	1942	2097	2330	48	27/30	29	156
	ME26B	2014	2175	2416	48	33/36	29	175
	ME26C	1983	2141	2379	54	27/30	29	174
	ME26D	2055	2219	2466	54	33/36	29	196
	ME26E	2014	2175	2416	60	27/30	29	191
	ME26F	2096	2264	2515	60	33/36	29	226
	ME26G	2055	2219	2466	66	27/30	29	206
	ME26H	2137	2308	2565	66	33/36	29	254
	ME26J	2096	2264	2515	72	27/30	29	222
	ME26K	2178	2353	2614	72	33/36	29	281

**Veneer species must be noted on each line item**

Quarter boat left hand, end forms joint with the profile of worksurface to which it is connected. Metal base support available in satin nickel or black powder coat finish, please specify on order.

**Veneer species must be noted on each line item**

<u>Veneer Grade 1</u>	<u>Veneer Grade 2</u>	<u>Veneer Grade 3</u>
Cherry	Rift Oak	Anigre
Maple	Sapele	
Ligno-Grain		
Walnut		

# HBF Mercer Casegoods - Desk Extensions

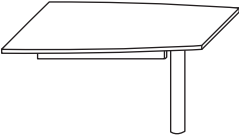
Style Number	List Price			Dimensions			Weight	
	Veneer 1	Veneer 2	Veneer 3	OW	OD	OH		
	ME27A	1942	2097	2330	48	27/30	29	156
	ME27B	2014	2175	2416	48	33/36	29	175
	ME27C	1983	2141	2379	54	27/30	29	174
	ME27D	2055	2219	2466	54	33/36	29	196
	ME27E	2014	2175	2416	60	27/30	29	191
	ME27F	2096	2264	2515	60	33/36	29	226
	ME27G	2055	2219	2466	66	27/30	29	206
	ME27H	2137	2308	2565	66	33/36	29	254
	ME27J	2096	2264	2515	72	27/30	29	222
	ME27K	2178	2353	2614	72	33/36	29	281

Veneer species must be noted on each line item

Quarter boat right hand, end forms joint with the profile of worksurface to which it is connected. Metal base support available in satin nickel or black powder coat finish, please specify on order.

## Desk Extensions with end panel

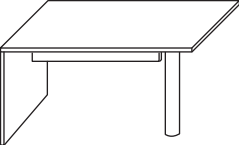
	ME20J-K	2446	2642	2936	72	30	29	251
	ME20K-K	2518	2720	3022	72	36	29	261
	ME20L-K	2487	2686	2985	84	30	29	266
	ME20M-K	2560	2764	3071	84	36	29	271
	ME20N-K	2529	2731	3034	96	30	29	276
	ME20P-K	2601	2809	3121	96	36	29	281

Veneer species must be noted on each line item

Rectangular, metal base support available in satin nickel or black powder coat finish, please specify on order.

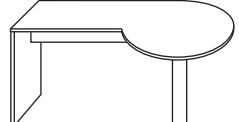
	ME22J-K	3188	3443	3825	72	30/36	29	310
	ME22K-K	3301	3565	3961	72	36/42	29	320
	ME22L-K	3250	3510	3900	84	30/36	29	325
	ME22M-K	3363	3632	4036	84	36/42	29	330
	ME22N-K	3311	3576	3974	96	30/36	29	335
	ME22P-K	3425	3699	4110	96	36/42	29	340

Veneer species must be noted on each line item

"P" left hand, metal base support available in satin nickel or black powder coat finish, please specify on order.

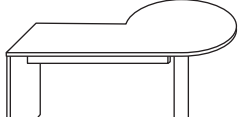
	ME23J-K	3188	3443	3825	72	30/36	29	310
	ME23K-K	3301	3565	3961	72	36/42	29	320
	ME23L-K	3250	3510	3900	84	30/36	29	325
	ME23M-K	3363	3632	4036	84	36/42	29	330
	ME23N-K	3311	3576	3974	96	30/36	29	335
	ME23P-K	3425	3699	4110	96	36/42	29	340

Veneer species must be noted on each line item

"P" right hand, metal base support available in satin nickel or black powder coat finish, please specify on order.

### Veneer species must be noted on each line item

Veneer Grade 1	Veneer Grade 2	Veneer Grade 3
Cherry	Rift Oak	Anigre
Maple	Sapele	
Ligno-Grain		
Walnut		



# HBF Mercer Casegoods - Returns

Style Number	List Price			Dimensions			Weight
	Veneer 1	Veneer 2	Veneer 3	OW	OD	OH	

## Desk Extensions with end panel

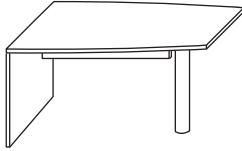

ME24J-K	2776	2998	3331	72	24/30	29	251
ME24K-K	2858	3087	3430	72	30/36	29	261
ME24L-K	2817	3042	3380	84	24/30	29	266
ME24M-K	2899	3131	3479	84	30/36	29	271
ME24N-K	2858	3087	3430	96	24/30	29	276
ME24P-K	2941	3176	3529	96	30/36	29	281

Veneer species must be noted on each line item

Half boat, metal base support available in satin nickel or black powder coat finish, please specify on order.

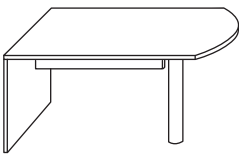

ME25J-K	2663	2876	3195	72	30	29	251
ME25K-K	2745	2965	3294	72	36	29	261
ME25L-K	2704	2920	3245	84	30	29	266
ME25M-K	2786	3009	3343	84	36	29	271
ME25N-K	2745	2965	3294	96	30	29	276
ME25P-K	2827	3054	3393	96	36	29	281

Veneer species must be noted on each line item

Half boat, metal base support available in satin nickel or black powder coat finish, please specify on order.

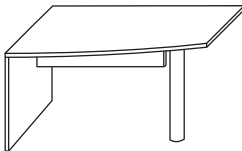

ME26J-K	2663	2876	3195	72	27/30	29	251
ME26K-K	2745	2965	3294	72	33/36	29	261
ME26L-K	2704	2920	3245	84	27/30	29	266
ME26M-K	2786	3009	3343	84	33/36	29	271
ME26N-K	2745	2965	3294	96	27/30	29	276
ME26P-K	2827	3054	3393	96	33/36	29	281

Veneer species must be noted on each line item

Quarter boat left hand, metal base support available in satin nickel or black powder coat finish, please specify on order.

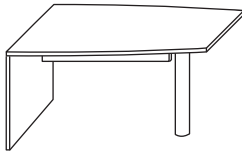

ME27J-K	2663	2876	3195	72	27/30	29	251
ME27K-K	2745	2965	3294	72	33/36	29	261
ME27L-K	2704	2920	3245	84	27/30	29	266
ME27M-K	2786	3009	3343	84	33/36	29	271
ME27N-K	2745	2965	3294	96	27/30	29	276
ME27P-K	2827	3054	3393	96	33/36	29	281

Veneer species must be noted on each line item

Quarter boat right hand, metal base support available in satin nickel or black powder coat finish, please specify on order.

Veneer species must be noted on each line item

Veneer Grade 1	Veneer Grade 2	Veneer Grade 3
Cherry	Rift Oak	Anigre
Maple	Sapele	
Ligno-Grain		
Walnut		

# HBF Mercer Casegoods - Storage Units

Style Number	List Price			Dimensions			Weight
	Veneer 1	Veneer 2	Veneer 3	OW	OD	OH	
<b>Mobile File Pedestal</b>							
<b>ME30</b>	<b>1746</b>	<b>1886</b>	<b>2095</b>	18	20	24 1/2	147

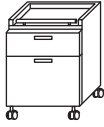

**Veneer species must be noted on each line item**  
 Casters, one box drawer and one file drawer. Metal pull on front to provide ease of movement, face lock. File pedestal will nest under any 29" OH worksurface.

## Credenza Storage Towers

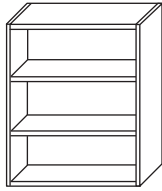
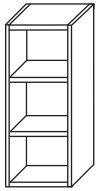

<b>ME68F</b>	<b>1736</b>	<b>1874</b>	<b>2083</b>	18	14 7/8	42 1/4	87
<b>ME68D</b>	<b>2302</b>	<b>2486</b>	<b>2762</b>	30	14 7/8	42 1/4	97
<b>ME68E</b>	<b>2446</b>	<b>2642</b>	<b>2936</b>	36	14 7/8	42 1/4	97

**Veneer species must be noted on each line item**  
 Flush top, no profile edge detail, two adjustable shelves, unfinished back, sits on credenza.

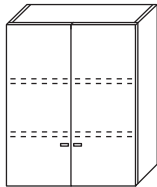
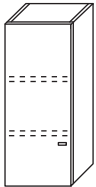

<b>ME69F</b>	<b>2271</b>	<b>2453</b>	<b>2725</b>	18	15 3/4	42 1/4	97
<b>ME69D</b>	<b>2807</b>	<b>3031</b>	<b>3368</b>	30	15 3/4	42 1/4	117
<b>ME69E</b>	<b>2930</b>	<b>3165</b>	<b>3516</b>	36	15 3/4	42 1/4	117

**Veneer species must be noted on each line item**  
 Flush top, no profile edge detail, two adjustable shelves, unfinished back, sits on credenza. 18" OW storage towers are one-door units, specify left or right hinge. 30" and 36" OW towers are two-door units.

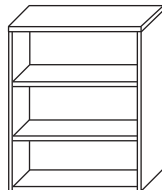
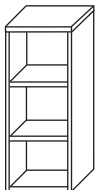

<b>ME68C</b>	<b>1931</b>	<b>2086</b>	<b>2318</b>	18	14 7/8	43 5/8	87
<b>ME68A</b>	<b>2549</b>	<b>2753</b>	<b>3059</b>	30	14 7/8	43 5/8	97
<b>ME68B</b>	<b>2745</b>	<b>2965</b>	<b>3294</b>	36	14 7/8	43 5/8	97

**Veneer species must be noted on each line item**  
 Top profile edge detail, two adjustable shelves, unfinished back, sits on credenza.

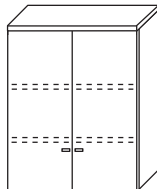
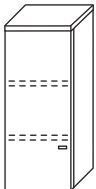

<b>ME69C</b>	<b>2457</b>	<b>2653</b>	<b>2948</b>	18	15 3/4	43 5/8	97
<b>ME69A</b>	<b>3044</b>	<b>3287</b>	<b>3652</b>	30	15 3/4	43 5/8	117
<b>ME69B</b>	<b>3239</b>	<b>3498</b>	<b>3887</b>	36	15 3/4	43 5/8	117

**Veneer species must be noted on each line item**  
 Top profile edge detail, two adjustable shelves, unfinished back, sits on credenza. 18" OW storage towers are one-door units, specify left or right hinge. 30" and 36" OW towers are two-door units.

### Veneer species must be noted on each line item

<u>Veneer Grade 1</u>	<u>Veneer Grade 2</u>	<u>Veneer Grade 3</u>
Cherry	Rift Oak	Anigre
Maple	Sapele	
Ligno-Grain		
Walnut		

# HBF Mercer Casegoods - Storage Units

Style Number	List Price			Dimensions			Weight
	Veneer 1	Veneer 2	Veneer 3	OW	OD	OH	

## Credenza Storage Towers

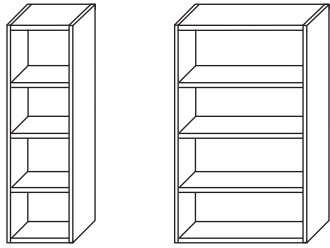

ME68F2	2354	2542	2824	18	14 7/8	56	95
ME68D2	3105	3354	3727	30	14 7/8	56	106
ME68E2	3311	3576	3974	36	14 7/8	56	106

Veneer species must be noted on each line item

Flush top, no profile edge detail, three adjustable shelves, unfinished back, sits on credenza.

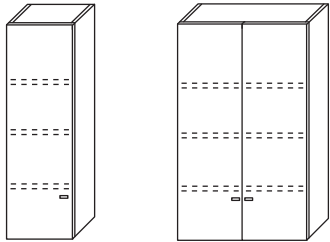

ME69F2	3064	3309	3677	18	15 3/4	56	106
ME69D2	3785	4088	4542	30	15 3/4	56	127
ME69E2	3960	4277	4752	36	15 3/4	56	127

Veneer species must be noted on each line item

Flush top, no profile edge detail, three adjustable shelves, unfinished back, sits on credenza. 18" OW storage towers are one-door units, specify left or right hinge. 30" and 36" OW towers are two-door units.

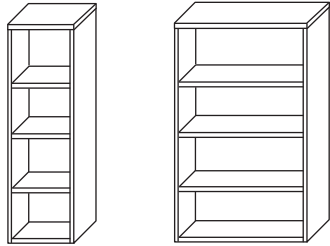

ME68C2	2611	2820	3133	18	14 7/8	57 3/8	95
ME68A2	3435	3710	4122	30	14 7/8	57 3/8	106
ME68B2	3703	3999	4443	36	14 7/8	57 3/8	106

Veneer species must be noted on each line item

Top profile edge detail, three adjustable shelves, unfinished back, sits on credenza.

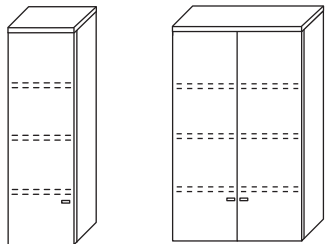

ME69C2	3322	3587	3986	18	15 3/4	57 3/8	106
ME69A2	4115	4444	4938	30	15 3/4	57 3/8	127
ME69B2	4372	4722	5247	36	15 3/4	57 3/8	127

Veneer species must be noted on each line item

Top profile edge detail, three adjustable shelves, unfinished back, sits on credenza. 18" OW storage towers are one-door units, specify left or right hinge. 30" and 36" OW towers are two-door units.

Veneer species must be noted on each line item

Veneer Grade 1	Veneer Grade 2	Veneer Grade 3
Cherry	Rift Oak	Anigre
Maple	Sapele	
Ligno-Grain		
Walnut		

# HBF Mercer Casegoods - Storage Units

Style Number	List Price			Dimensions			Weight
	Veneer 1	Veneer 2	Veneer 3	OW	OD	OH	

## Credenza Storage Towers

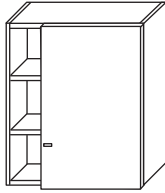

ME69D-P	3085	3332	3702	30	15 3/4	42 1/4	94
ME69E-P	3229	3487	3875	36	15 3/4	42 1/4	114

**Veneer species must be noted on each line item**

Flush top, no profile edge detail, two adjustable shelves, unfinished back, sits on credenza. All storage towers are one-door units, specify left or right hinge. Open storage area 7 3/4" wide.

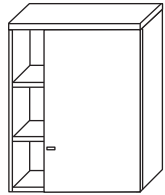

ME69A-P	3353	3621	4023	30	15 3/4	43 5/8	94
ME69B-P	3559	3843	4270	36	15 3/4	43 5/8	114

**Veneer species must be noted on each line item**

Top profile edge detail, two adjustable shelves, unfinished back, sits on credenza. All storage towers are one-door units, specify left or right hinge. Open storage area 7 3/4" wide.

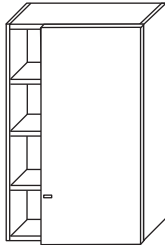

ME69D2-P	4166	4500	5000	30	15 3/4	56	103
ME69E2-P	4362	4711	5234	36	15 3/4	56	125

**Veneer species must be noted on each line item**

Flush top, no profile edge detail, three adjustable shelves, unfinished back, sits on credenza. All storage towers are one-door units, specify left or right hinge. Open storage area 7 3/4" wide.

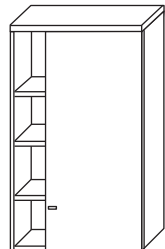

ME69A2-P	4527	4889	5432	30	15 3/4	57 3/8	103
ME69B2-P	4784	5167	5741	36	15 3/4	57 3/8	125

**Veneer species must be noted on each line item**

Top profile edge detail, three adjustable shelves, unfinished back, sits on credenza. All storage towers are one-door units, specify left or right hinge. Open storage area 7 3/4" wide.

**Veneer species must be noted on each line item**

<u>Veneer Grade 1</u>	<u>Veneer Grade 2</u>	<u>Veneer Grade 3</u>
Cherry	Rift Oak	Anigre
Maple	Sapele	
Ligno-Grain		
Walnut		

# HBF Mercer Casegoods - Overhead Cabinets

Style Number	Fabric	List Price			Dimensions			Weight
		Veneer 1	Veneer 2	Veneer 3	OW	OD	OH	

## Overhead Cabinets, Top without Profile Edge Detail, Wood Panel Support

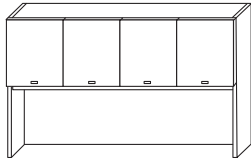

<b>ME62M-FNP</b>	3 yds	<b>3384</b>	<b>3654</b>	<b>4060</b>	72	15 3/4	42 1/4	282
------------------	-------	-------------	-------------	-------------	----	--------	--------	-----

**Veneer species must be noted on each line item**

Flush top without profile edge detail, fabric tack panel (fabric not included, COM must be acrylic backed), cabinet back unfinished. Optional task lights available, see HBF Casegood Accessories.

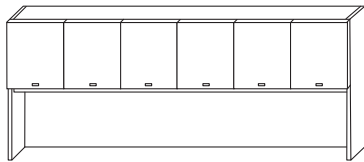

<b>ME62N-FNP</b>	3 yds	<b>3857</b>	<b>4166</b>	<b>4629</b>	78	15 3/4	42 1/4	289
<b>ME62P-FNP</b>	3 yds	<b>4043</b>	<b>4366</b>	<b>4851</b>	84	15 3/4	42 1/4	296
<b>ME62R-FNP</b>	3 yds	<b>4208</b>	<b>4544</b>	<b>5049</b>	90	15 3/4	42 1/4	339
<b>ME62S-FNP</b>	3 1/4 yds	<b>4383</b>	<b>4733</b>	<b>5259</b>	96	15 3/4	42 1/4	351
<b>ME62T-FNP</b>	3 1/2 yds	<b>4568</b>	<b>4933</b>	<b>5482</b>	102	15 3/4	42 1/4	365
<b>ME62U-FNP</b>	3 3/4 yds	<b>4733</b>	<b>5111</b>	<b>5679</b>	108	15 3/4	42 1/4	376
<b>ME62V-FNP</b>	4 1/4 yds	<b>4918</b>	<b>5312</b>	<b>5902</b>	114	15 3/4	42 1/4	391
<b>ME62W-FNP</b>	4 1/4 yds	<b>5104</b>	<b>5512</b>	<b>6124</b>	120	15 3/4	42 1/4	406

**Veneer species must be noted on each line item**

Flush top without profile edge detail, fabric tack panel (fabric not included, COM must be acrylic backed), cabinet back unfinished. Optional task lights available, see HBF Casegood Accessories.

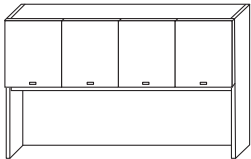

<b>ME63M-FNP</b>		<b>3600</b>	<b>3888</b>	<b>4320</b>	72	15 3/4	42 1/4	282
------------------	--	-------------	-------------	-------------	----	--------	--------	-----

**Veneer species must be noted on each line item**

Flush top without profile edge detail, finished wood panel, cabinet back unfinished. Optional task lights available, see HBF Casegood Accessories.

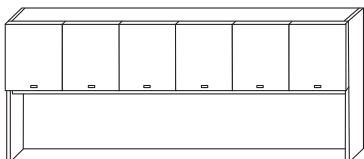

<b>ME63N-FNP</b>		<b>4105</b>	<b>4433</b>	<b>4925</b>	78	15 3/4	42 1/4	289
<b>ME63P-FNP</b>		<b>4300</b>	<b>4644</b>	<b>5160</b>	84	15 3/4	42 1/4	296
<b>ME63R-FNP</b>		<b>4475</b>	<b>4833</b>	<b>5370</b>	90	15 3/4	42 1/4	339
<b>ME63S-FNP</b>		<b>4661</b>	<b>5034</b>	<b>5593</b>	96	15 3/4	42 1/4	351
<b>ME63T-FNP</b>		<b>4860</b>	<b>5428</b>	<b>5831</b>	102	15 3/4	42 1/4	365
<b>ME63U-FNP</b>		<b>5032</b>	<b>5434</b>	<b>6038</b>	108	15 3/4	42 1/4	376
<b>ME63V-FNP</b>		<b>5217</b>	<b>5634</b>	<b>6260</b>	114	15 3/4	42 1/4	391
<b>ME63W-FNP</b>		<b>5402</b>	<b>5835</b>	<b>6483</b>	120	15 3/4	42 1/4	406

**Veneer species must be noted on each line item**

Flush top without profile edge detail, finished wood panel, cabinet back unfinished. Optional task lights available, see HBF Casegood Accessories.

### Veneer species must be noted on each line item

<u>Veneer Grade 1</u>	<u>Veneer Grade 2</u>	<u>Veneer Grade 3</u>
Cherry	Rift Oak	Anigre
Maple	Sapele	
Ligno-Grain		
Walnut		

# HBF Mercer Casegoods - Overhead Cabinets

Style Number	Fabric	List Price			Dimensions			Weight
		Veneer 1	Veneer 2	Veneer 3	OW	OD	OH	

## Overhead Cabinets, Top without Profile Edge Detail, Wood Panel Support

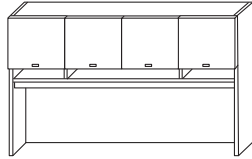

ME62M-FWP	3 yds	3723	4021	4468	72	15 3/4	42 1/4	282
-----------	-------	------	------	------	----	--------	--------	-----

**Veneer species must be noted on each line item**

Flush top without profile edge detail, fabric tack panel (fabric not included, COM must be acrylic backed). Open project shelf storage 3" high. Cabinet back unfinished. Optional task lights available, see HBF Casegood Accessories.

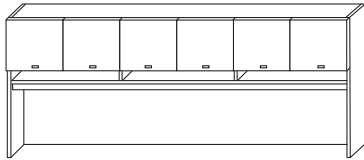

ME62N-FWP	3 yds	4249	4589	5099	78	15 3/4	42 1/4	289
ME62P-FWP	3 yds	4444	4800	5333	84	15 3/4	42 1/4	296
ME62R-FWP	3 yds	4630	5000	5556	90	15 3/4	42 1/4	339
ME62S-FWP	3 1/4 yds	4826	5212	5791	96	15 3/4	42 1/4	351
ME62T-FWP	3 1/2 yds	5021	5423	6026	102	15 3/4	42 1/4	365
ME62U-FWP	3 3/4 yds	5207	5623	6248	108	15 3/4	42 1/4	376
ME62V-FWP	4 1/4 yds	5392	5823	6470	114	15 3/4	42 1/4	391
ME62W-FWP	4 1/4 yds	5577	6024	6693	120	15 3/4	42 1/4	406

**Veneer species must be noted on each line item**

Flush top without profile edge detail, fabric tack panel (fabric not included, COM must be acrylic backed). Open project shelf storage 3" high. Cabinet back unfinished. Optional task lights available, see HBF Casegood Accessories.

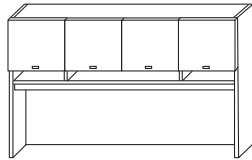

ME63M-FWP		3960	4277	4752	72	15 3/4	42 1/4	282
-----------	--	------	------	------	----	--------	--------	-----

**Veneer species must be noted on each line item**

Flush top without profile edge detail, finished wood panel. Open project shelf storage 3" high. Cabinet back unfinished. Optional task lights available, see HBF Casegood Accessories.

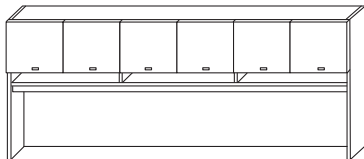

ME63N-FWP		4517	4878	5420	78	15 3/4	42 1/4	289
ME63P-FWP		4733	5111	5679	84	15 3/4	42 1/4	296
ME63R-FWP		4929	5323	5914	90	15 3/4	42 1/4	339
ME63S-FWP		5135	5545	6161	96	15 3/4	42 1/4	351
ME63T-FWP		5351	5779	6421	102	15 3/4	42 1/4	365
ME63U-FWP		5536	5979	6644	108	15 3/4	42 1/4	376
ME63V-FWP		5722	6179	6866	114	15 3/4	42 1/4	391
ME63W-FWP		5907	6380	7088	120	15 3/4	42 1/4	406

**Veneer species must be noted on each line item**

Flush top without profile edge detail, finished wood panel. Open project shelf storage 3" high. Cabinet back unfinished. Optional task lights available, see HBF Casegood Accessories.

**Veneer species must be noted on each line item**

<u>Veneer Grade 1</u>	<u>Veneer Grade 2</u>	<u>Veneer Grade 3</u>
Cherry	Rift Oak	Anigre
Maple	Sapele	
Ligno-Grain		
Walnut		

# HBF Mercer Casegoods - Overhead Cabinets

Style Number	Fabric	List Price			Dimensions			Weight
		Veneer 1	Veneer 2	Veneer 3	OW	OD	OH	

## Overhead Cabinets, Top without Profile Edge Detail, Wood Panel Support

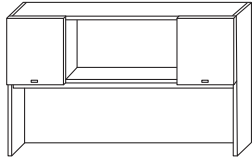

ME62M-PNP	3 yds	3208	3465	3850	72	15 3/4	42 1/4	282
-----------	-------	------	------	------	----	--------	--------	-----

**Veneer species must be noted on each line item**

Flush top without profile edge detail, fabric tack panel (fabric not included, COM must be acrylic backed). Open center storage. Cabinet back unfinished. Optional task lights available, see HBF Casegood Accessories.

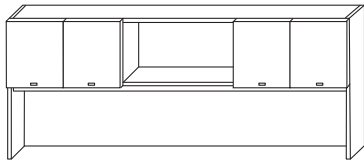

ME62N-PNP	3 yds	3672	3966	4406	78	15 3/4	42 1/4	289
ME62P-PNP	3 yds	3837	4144	4604	84	15 3/4	42 1/4	296
ME62R-PNP	3 yds	4002	4322	4802	90	15 3/4	42 1/4	339
ME62S-PNP	3 1/4 yds	4166	4500	5000	96	15 3/4	42 1/4	351
ME62T-PNP	3 1/2 yds	4331	4678	5197	102	15 3/4	42 1/4	365
ME62U-PNP	3 3/4 yds	4496	4856	5395	108	15 3/4	42 1/4	376
ME62V-PNP	4 1/4 yds	4681	5056	5618	114	15 3/4	42 1/4	391
ME62W-PNP	4 1/4 yds	4867	5256	5840	120	15 3/4	42 1/4	406

**Veneer species must be noted on each line item**

Flush top without profile edge detail, fabric tack panel (fabric not included, COM must be acrylic backed). Open center storage. Cabinet back unfinished. Optional task lights available, see HBF Casegood Accessories.

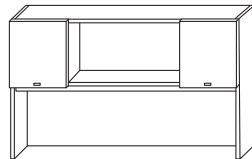

ME63M-PNP		3425	3699	4110	72	15 3/4	42 1/4	282
-----------	--	------	------	------	----	--------	--------	-----

**Veneer species must be noted on each line item**

Flush top without profile edge detail, finished wood panel. Open center storage. Cabinet back unfinished. Optional task lights available, see HBF Casegood Accessories.

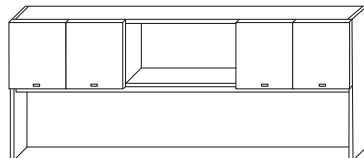

ME63N-PNP		3899	4210	4678	78	15 3/4	42 1/4	289
ME63P-PNP		4084	4411	4901	84	15 3/4	42 1/4	296
ME63R-PNP		4249	4589	5099	90	15 3/4	42 1/4	339
ME63S-PNP		4434	4789	5321	96	15 3/4	42 1/4	351
ME63T-PNP		4620	4989	5543	102	15 3/4	42 1/4	365
ME63U-PNP		4784	5167	5741	108	15 3/4	42 1/4	376
ME63V-PNP		4970	5367	5964	114	15 3/4	42 1/4	391
ME63W-PNP		5155	5568	6186	120	15 3/4	42 1/4	406

**Veneer species must be noted on each line item**

Flush top without profile edge detail, finished wood panel. Open center storage. Cabinet back unfinished. Optional task lights available, see HBF Casegood Accessories.

### Veneer species must be noted on each line item

Veneer Grade 1	Veneer Grade 2	Veneer Grade 3
Cherry	Rift Oak	Anigre
Maple	Sapele	
Ligno-Grain		
Walnut		

# HBF Mercer Casegoods - Overhead Cabinets

Style Number	Fabric	List Price			Dimensions			Weight
		Veneer 1	Veneer 2	Veneer 3	OW	OD	OH	

## Overhead Cabinets, Top without Profile Edge Detail, Wood Panel Support

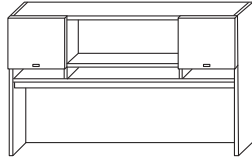

ME62M-PWP	3 yds	3548	3832	4258	72	15 3/4	42 1/4	282
-----------	-------	------	------	------	----	--------	--------	-----

**Veneer species must be noted on each line item**

Flush top without profile edge detail, fabric tack panel (fabric not included, COM must be acrylic backed). Open project shelf storage 3" high and open center storage. Cabinet back unfinished. Optional task lights available, see HBF Casegood Accessories.

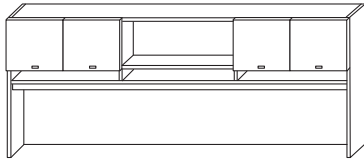

ME62N-PWP	3 yds	4053	4377	4864	78	15 3/4	42 1/4	289
ME62P-PWP	3 yds	4249	4589	5099	84	15 3/4	42 1/4	296
ME62R-PWP	3 yds	4424	4778	5309	90	15 3/4	42 1/4	339
ME62S-PWP	3 1/4 yds	4599	4967	5519	96	15 3/4	42 1/4	351
ME62T-PWP	3 1/2 yds	4795	5178	5754	102	15 3/4	42 1/4	365
ME62U-PWP	3 3/4 yds	4970	5367	5964	108	15 3/4	42 1/4	376
ME62V-PWP	4 1/4 yds	5155	5568	6186	114	15 3/4	42 1/4	391
ME62W-PWP	4 1/4 yds	5341	5768	6409	120	15 3/4	42 1/4	406

**Veneer species must be noted on each line item**

Flush top without profile edge detail, fabric tack panel (fabric not included, COM must be acrylic backed). Open project shelf storage 3" high and open center storage. Cabinet back unfinished. Optional task lights available, see HBF Casegood Accessories.

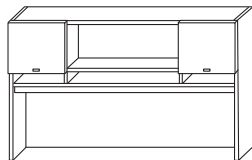

ME63M-PWP		3785	4088	4542	72	15 3/4	42 1/4	282
-----------	--	------	------	------	----	--------	--------	-----

**Veneer species must be noted on each line item**

Flush top without profile edge detail, finished wood panel. Open project shelf storage 3" high and open center storage. Cabinet back unfinished. Optional task lights available, see HBF Casegood Accessories.

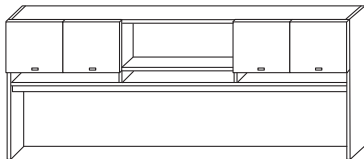

ME63N-PWP		4311	4655	5173	78	15 3/4	42 1/4	289
ME63P-PWP		4517	4878	5420	84	15 3/4	42 1/4	296
ME63R-PWP		4702	5078	5642	90	15 3/4	42 1/4	339
ME63S-PWP		4898	5289	5877	96	15 3/4	42 1/4	351
ME63T-PWP		5104	5512	6124	102	15 3/4	42 1/4	365
ME63U-PWP		5289	5712	6347	108	15 3/4	42 1/4	376
ME63V-PWP		5474	5912	6569	114	15 3/4	42 1/4	391
ME63W-PWP		5660	6113	6792	120	15 3/4	42 1/4	406

**Veneer species must be noted on each line item**

Flush top without profile edge detail, finished wood panel. Open project shelf storage 3" high and open center storage. Cabinet back unfinished. Optional task lights available, see HBF Casegood Accessories.

**Veneer species must be noted on each line item**

<u>Veneer Grade 1</u>	<u>Veneer Grade 2</u>	<u>Veneer Grade 3</u>
Cherry	Rift Oak	Anigre
Maple	Sapele	
Ligno-Grain		
Walnut		



# HBF Mercer Casegoods - Overhead Cabinets

Style Number	Fabric	List Price			Dimensions			Weight
		Veneer 1	Veneer 2	Veneer 3	OW	OD	OH	

**Overhead Cabinets, Top without Profile Edge Detail, Wood Panel Support (Double High)**

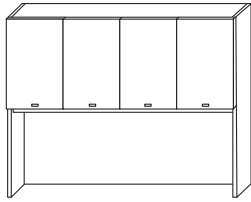

ME62M2-FNP	3 yds	4568	4933	5482	72	15 3/4	56	312
------------	-------	------	------	------	----	--------	----	-----

**Veneer species must be noted on each line item**

Flush top without profile edge detail, one adjustable shelf, fabric tack panel (fabric not included, COM must be acrylic backed). Cabinet back unfinished. Optional task lights available, see HBF Casegood Accessories.

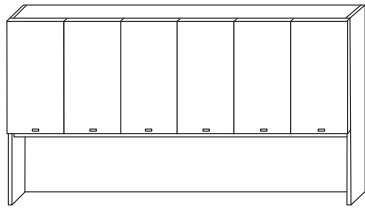

ME62N2-FNP	3 yds	5217	5634	6260	78	15 3/4	56	319
ME62P2-FNP	3 yds	5464	5901	6557	84	15 3/4	56	326
ME62R2-FNP	3 yds	5691	6146	6829	90	15 3/4	56	379
ME62S2-FNP	3 1/4 yds	5928	6402	7113	96	15 3/4	56	391
ME62T2-FNP	3 1/2 yds	6165	6658	7397	102	15 3/4	56	405
ME62U2-FNP	3 3/4 yds	6401	6914	7682	108	15 3/4	56	416
ME62V2-FNP	4 1/4 yds	6638	7169	7966	114	15 3/4	56	441
ME62W2-FNP	4 1/4 yds	6875	7425	8250	120	15 3/4	56	456

**Veneer species must be noted on each line item**

Flush top without profile edge detail, one adjustable shelf, fabric tack panel (fabric not included, COM must be acrylic backed). Cabinet back unfinished. Optional task lights available, see HBF Casegood Accessories.

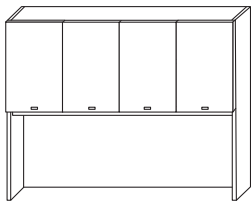

ME63M2-FNP		4867	5256	5840	72	15 3/4	56	312
------------	--	------	------	------	----	--------	----	-----

**Veneer species must be noted on each line item**

Flush top without profile edge detail, one adjustable shelf, finished wood panel. Cabinet back unfinished. Optional task lights available, see HBF Casegood Accessories.

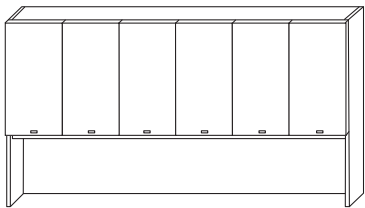

ME63N2-FNP		5547	5990	6656	78	15 3/4	56	319
ME63P2-FNP		5814	6279	6977	84	15 3/4	56	326
ME63R2-FNP		6051	6535	7262	90	15 3/4	56	379
ME63S2-FNP		6298	6802	7558	96	15 3/4	56	391
ME63T2-FNP		6566	7092	7880	102	15 3/4	56	405
ME63U2-FNP		6803	7347	8164	108	15 3/4	56	416
ME63V2-FNP		7040	7603	8448	114	15 3/4	56	441
ME63W2-FNP		7277	7859	8732	120	15 3/4	56	456

**Veneer species must be noted on each line item**

Flush top without profile edge detail, one adjustable shelf, finished wood panel. Cabinet back unfinished. Optional task lights available, see HBF Casegood Accessories.

**Double high overhead cabinets to be used with double high vertical cabinets.**

**Veneer species must be noted on each line item**

<u>Veneer Grade 1</u>	<u>Veneer Grade 2</u>	<u>Veneer Grade 3</u>
Cherry	Rift Oak	Anigre
Maple	Sapele	
Ligno-Grain		
Walnut		

# HBF Mercer Casegoods - Overhead Cabinets

Style Number	Fabric	List Price			Dimensions			Weight
		Veneer 1	Veneer 2	Veneer 3	OW	OD	OH	

**Overhead Cabinets, Top without Profile Edge Detail, Wood Panel Support (Double High)**

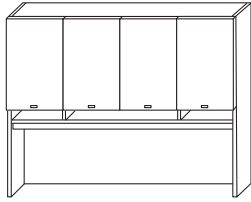

ME62M2-FWP	3 yds	5021	5423	6026	72	15 3/4	56	312
------------	-------	------	------	------	----	--------	----	-----

**Veneer species must be noted on each line item**

Flush top without profile edge detail, one adjustable shelf, fabric tack panel (fabric not included, COM must be acrylic backed). Open project shelf storage 3" high. Cabinet back unfinished. Optional task lights available, see HBF Casegood Accessories.

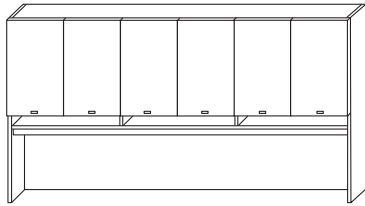

ME62N2-FWP	3 yds	5742	6202	6891	78	15 3/4	56	319
ME62P2-FWP	3 yds	6010	6491	7212	84	15 3/4	56	326
ME62R2-FWP	3 yds	6257	6758	7509	90	15 3/4	56	379
ME62S2-FWP	3 1/4 yds	6515	7036	7818	96	15 3/4	56	391
ME62T2-FWP	3 1/2 yds	6783	7325	8139	102	15 3/4	56	405
ME62U2-FWP	3 3/4 yds	7040	7603	8448	108	15 3/4	56	416
ME62V2-FWP	4 1/4 yds	7277	7859	8732	114	15 3/4	56	441
ME62W2-FWP	4 1/4 yds	7514	8115	9017	120	15 3/4	56	456

**Veneer species must be noted on each line item**

Flush top without profile edge detail, one adjustable shelf, fabric tack panel (fabric not included, COM must be acrylic backed). Open project shelf storage 3" high. Cabinet back unfinished. Optional task lights available, see HBF Casegood Accessories.

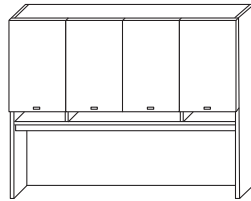

ME63M2-FWP		5351	5779	6421	72	15 3/4	56	312
------------	--	------	------	------	----	--------	----	-----

**Veneer species must be noted on each line item**

Flush top without profile edge detail, one adjustable shelf, finished wood panel. Open project shelf storage 3" high. Cabinet back unfinished. Optional task lights available, see HBF Casegood Accessories.

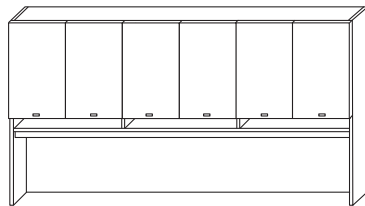

ME63N2-FWP		6103	6591	7323	78	15 3/4	56	319
ME63P2-FWP		6391	6902	7669	84	15 3/4	56	326
ME63R2-FWP		6659	7192	7991	90	15 3/4	56	379
ME63S2-FWP		6927	7481	8312	96	15 3/4	56	391
ME63T2-FWP		7225	7803	8671	102	15 3/4	56	405
ME63U2-FWP		7483	8082	8980	108	15 3/4	56	416
ME63V2-FWP		7720	8337	9264	114	15 3/4	56	441
ME63W2-FWP		7957	8593	9548	120	15 3/4	56	456

**Veneer species must be noted on each line item**

Flush top without profile edge detail, one adjustable shelf, finished wood panel. Open project shelf storage 3" high. Cabinet back unfinished. Optional task lights available, see HBF Casegood Accessories.

**Double high overhead cabinets to be used with double high vertical cabinets.**

**Veneer species must be noted on each line item**

Veneer Grade 1	Veneer Grade 2	Veneer Grade 3
Cherry	Rift Oak	Anigre
Maple	Sapele	
Ligno-Grain		
Walnut		

# HBF Mercer Casegoods - Overhead Cabinets

Style Number	Fabric	List Price			Dimensions			Weight
		Veneer 1	Veneer 2	Veneer 3	OW	OD	OH	

**Overhead Cabinets, Top without Profile Edge Detail, Wood Panel Support (Double High)**

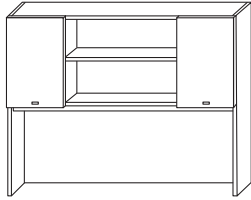

ME62M2-PNP	3 yds	4341	4689	5210	72	15 3/4	56	312
------------	-------	------	------	------	----	--------	----	-----

**Veneer species must be noted on each line item**

Flush top without profile edge detail, fabric tack panel (fabric not included, COM must be acrylic backed). Open center storage, one adjustable shelf. Cabinet back unfinished. Optional task lights available, see HBF Casegood Accessories.

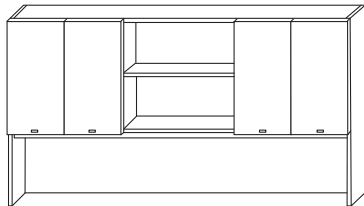

ME62N2-PNP	3 yds	4959	5356	5951	78	15 3/4	56	319
ME62P2-PNP	3 yds	5186	5601	6223	84	15 3/4	56	326
ME62R2-PNP	3 yds	5413	5846	6495	90	15 3/4	56	379
ME62S2-PNP	3 1/4 yds	5629	6079	6755	96	15 3/4	56	391
ME62T2-PNP	3 1/2 yds	5856	6324	7027	102	15 3/4	56	405
ME62U2-PNP	3 3/4 yds	6082	6569	7299	108	15 3/4	56	416
ME62V2-PNP	4 1/4 yds	6319	6825	7583	114	15 3/4	56	441
ME62W2-PNP	4 1/4 yds	6556	7080	7867	120	15 3/4	56	456

**Veneer species must be noted on each line item**

Flush top without profile edge detail, fabric tack panel (fabric not included, COM must be acrylic backed). Open center storage, one adjustable shelf. Cabinet back unfinished. Optional task lights available, see HBF Casegood Accessories.

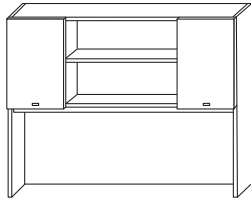

ME63M2-PNP		4620	4989	5543	72	15 3/4	56	312
------------	--	------	------	------	----	--------	----	-----

**Veneer species must be noted on each line item**

Flush top without profile edge detail, finished wood panel. Open center storage, one adjustable shelf. Cabinet back unfinished. Optional task lights available, see HBF Casegood Accessories.

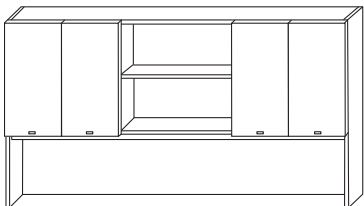

ME63N2-PNP		5268	5690	6322	78	15 3/4	56	319
ME63P2-PNP		5526	5968	6631	84	15 3/4	56	326
ME63R2-PNP		5742	6202	6891	90	15 3/4	56	379
ME63S2-PNP		5989	6469	7187	96	15 3/4	56	391
ME63T2-PNP		6237	6736	7484	102	15 3/4	56	405
ME63U2-PNP		6463	6980	7756	108	15 3/4	56	416
ME63V2-PNP		6700	7236	8040	114	15 3/4	56	441
ME63W2-PNP		6937	7492	8324	120	15 3/4	56	456

**Veneer species must be noted on each line item**

Flush top without profile edge detail, finished wood panel. Open center storage, one adjustable shelf. Cabinet back unfinished. Optional task lights available, see HBF Casegood Accessories.

**Double high overhead cabinets to be used with double high vertical cabinets.**

**Veneer species must be noted on each line item**

Veneer Grade 1	Veneer Grade 2	Veneer Grade 3
Cherry	Rift Oak	Anigre
Maple	Sapele	
Ligno-Grain		
Walnut		

# HBF Mercer Casegoods - Overhead Cabinets

Style Number	Fabric	List Price			Dimensions			Weight
		Veneer 1	Veneer 2	Veneer 3	OW	OD	OH	

## Overhead Cabinets, Top without Profile Edge Detail, Wood Panel Support (Double High)

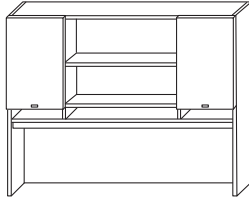

ME62M2-PWP	3 yds	4795	5178	5754	72	15 3/4	56	312
------------	-------	------	------	------	----	--------	----	-----

**Veneer species must be noted on each line item**

Flush top without profile edge detail, fabric tack panel (fabric not included, COM must be acrylic backed). Open center storage, one adjustable shelf, open project shelf storage 3" high. Cabinet back unfinished. Optional task lights available, see HBF Casegood Accessories.

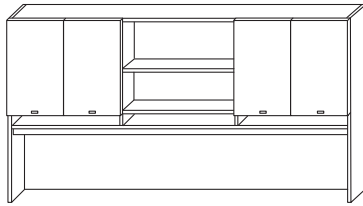

ME62N2-PWP	3 yds	5485	5924	6582	78	15 3/4	56	319
ME62P2-PWP	3 yds	5732	6191	6878	84	15 3/4	56	326
ME62R2-PWP	3 yds	5979	6457	7175	90	15 3/4	56	379
ME62S2-PWP	3 1/4 yds	6216	6713	7459	96	15 3/4	56	391
ME62T2-PWP	3 1/2 yds	6474	6991	7768	102	15 3/4	56	405
ME62U2-PWP	3 3/4 yds	6721	7258	8065	108	15 3/4	56	416
ME62V2-PWP	4 1/4 yds	6958	7514	8349	114	15 3/4	56	441
ME62W2-PWP	4 1/4 yds	7195	7770	8633	120	15 3/4	56	456

**Veneer species must be noted on each line item**

Flush top without profile edge detail, fabric tack panel (fabric not included, COM must be acrylic backed). Open center storage, one adjustable shelf, open project shelf storage 3" high. Cabinet back unfinished. Optional task lights available, see HBF Casegood Accessories.

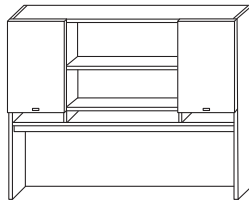

ME63M2-PWP		5104	5512	6124	72	15 3/4	56	312
------------	--	------	------	------	----	--------	----	-----

**Veneer species must be noted on each line item**

Flush top without profile edge detail, finished wood panel. Open center storage, one adjustable shelf, open project shelf storage 3" high. Cabinet back unfinished. Optional task lights available, see HBF Casegood Accessories.

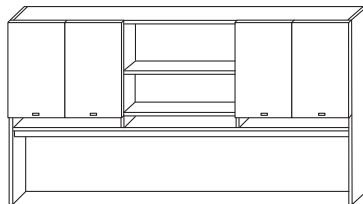

ME63N2-PWP		5825	6291	6990	78	15 3/4	56	319
ME63P2-PWP		6103	6591	7323	84	15 3/4	56	326
ME63R2-PWP		6350	6858	7620	90	15 3/4	56	379
ME63S2-PWP		6618	7147	7941	96	15 3/4	56	391
ME63T2-PWP		6896	7448	8275	102	15 3/4	56	405
ME63U2-PWP		7143	7714	8572	108	15 3/4	56	416
ME63V2-PWP		7380	7970	8856	114	15 3/4	56	441
ME63W2-PWP		7617	8226	9140	120	15 3/4	56	456

**Veneer species must be noted on each line item**

Flush top without profile edge detail, finished wood panel. Open center storage, one adjustable shelf, open project shelf storage 3" high. Cabinet back unfinished. Optional task lights available, see HBF Casegood Accessories.

**Double high overhead cabinets to be used with double high vertical cabinets.**

**Veneer species must be noted on each line item**

Veneer Grade 1	Veneer Grade 2	Veneer Grade 3
Cherry	Rift Oak	Anigre
Maple	Sapele	
Ligno-Grain		
Walnut		

# HBF Mercer Casegoods - Overhead Cabinets

Style Number	Fabric	List Price			Dimensions			Weight
		Veneer 1	Veneer 2	Veneer 3	OW	OD	OH	

## Overhead Cabinets, Top with Profile Edge Detail, Wood Panel Support

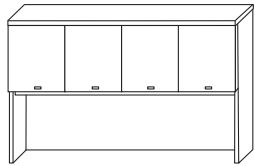

ME62A-FNP	3 yds	3651	3943	4382	72	15 3/4	43 5/8	282
-----------	-------	------	------	------	----	--------	--------	-----

**Veneer species must be noted on each line item**

Top with profile edge detail, fabric tack panel (fabric not included, COM must be acrylic backed), cabinet back unfinished. Optional task lights available, see HBF Casegood Accessories.

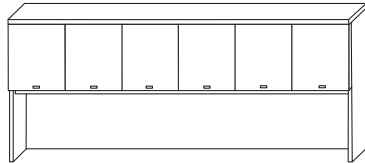

ME62F-FNP	3 yds	4166	4500	5000	78	15 3/4	43 5/8	289
ME62B-FNP	3 yds	4362	4711	5234	84	15 3/4	43 5/8	296
ME62C-FNP	3 yds	4547	4911	5457	90	15 3/4	43 5/8	339
ME62D-FNP	3 1/4 yds	4733	5111	5679	96	15 3/4	43 5/8	351
ME62G-FNP	3 1/2 yds	4929	5323	5914	102	15 3/4	43 5/8	365
ME62E-FNP	3 3/4 yds	5114	5523	6137	108	15 3/4	43 5/8	376
ME62H-FNP	4 1/4 yds	5299	5723	6359	114	15 3/4	43 5/8	391
ME62J-FNP	4 1/4 yds	5485	5924	6582	120	15 3/4	43 5/8	406

**Veneer species must be noted on each line item**

Top with profile edge detail, fabric tack panel (fabric not included, COM must be acrylic backed), cabinet back unfinished. Optional task lights available, see HBF Casegood Accessories.

## Overhead Cabinets, Top with Profile Edge Detail, Wood Panel Support

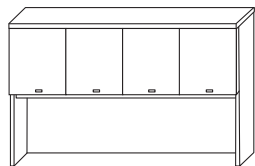

ME63A-FNP		3888	4199	4666	72	15 3/4	43 5/8	282
-----------	--	------	------	------	----	--------	--------	-----

**Veneer species must be noted on each line item**

Top with profile edge detail, finished wood panel, cabinet back unfinished. Optional task lights available, see HBF Casegood Accessories.

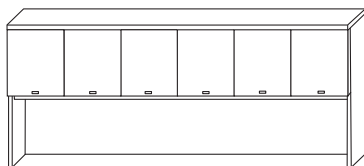

ME63F-FNP		4434	4789	5321	78	15 3/4	43 5/8	289
ME63B-FNP		4650	5022	5581	84	15 3/4	43 5/8	296
ME63C-FNP		4836	5223	5803	90	15 3/4	43 5/8	339
ME63D-FNP		5032	5434	6038	96	15 3/4	43 5/8	351
ME63G-FNP		5248	5668	6297	102	15 3/4	43 5/8	365
ME63E-FNP		5433	5868	6520	108	15 3/4	43 5/8	376
ME63H-FNP		5619	6068	6742	114	15 3/4	43 5/8	391
ME63J-FNP		5804	6268	6965	120	15 3/4	43 5/8	406

**Veneer species must be noted on each line item**

Top with profile edge detail, finished wood panel, cabinet back unfinished. Optional task lights available, see HBF Casegood Accessories.

**Veneer species must be noted on each line item**

Veneer Grade 1	Veneer Grade 2	Veneer Grade 3
Cherry	Rift Oak	Anigre
Maple	Sapele	
Ligno-Grain		
Walnut		

# HBF Mercer Casegoods - Overhead Cabinets

Style Number	Fabric	List Price			Dimensions			Weight
		Veneer 1	Veneer 2	Veneer 3	OW	OD	OH	

**Overhead Cabinets, Top with Profile Edge Detail, Wood Panel Support**

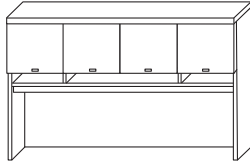

<b>ME62A-FWP</b>	3 yds	<b>4012</b>	<b>4333</b>	<b>4814</b>	72	15 3/4	43 5/8	282
------------------	-------	-------------	-------------	-------------	----	--------	--------	-----

**Veneer species must be noted on each line item**

Top with profile edge detail, fabric tack panel. Open project shelf storage 3" high. Cabinet back unfinished. Optional task lights available, see HBF Casegood Accessories.

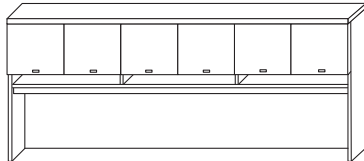

<b>ME62F-FWP</b>	3 yds	<b>4589</b>	<b>4956</b>	<b>5506</b>	78	15 3/4	43 5/8	289
<b>ME62B-FWP</b>	3 yds	<b>4805</b>	<b>5189</b>	<b>5766</b>	84	15 3/4	43 5/8	296
<b>ME62C-FWP</b>	3 yds	<b>5001</b>	<b>5401</b>	<b>6001</b>	90	15 3/4	43 5/8	339
<b>ME62D-FWP</b>	3 1/4 yds	<b>5207</b>	<b>5623</b>	<b>6248</b>	96	15 3/4	43 5/8	351
<b>ME62G-FWP</b>	3 1/2 yds	<b>5423</b>	<b>5857</b>	<b>6508</b>	102	15 3/4	43 5/8	365
<b>ME62E-FWP</b>	3 3/4 yds	<b>5619</b>	<b>6068</b>	<b>6742</b>	108	15 3/4	43 5/8	376
<b>ME62H-FWP</b>	4 1/4 yds	<b>5804</b>	<b>6268</b>	<b>6965</b>	114	15 3/4	43 5/8	391
<b>ME62J-FWP</b>	4 1/4 yds	<b>5989</b>	<b>6469</b>	<b>7187</b>	120	15 3/4	43 5/8	406

**Veneer species must be noted on each line item**

Top with profile edge detail, fabric tack panel. Open project shelf storage 3" high. Cabinet back unfinished. Optional task lights available, see HBF Casegood Accessories.

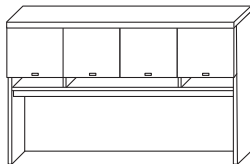

<b>ME63A-FWP</b>		<b>4280</b>	<b>4622</b>	<b>5136</b>	72	15 3/4	43 5/8	282
------------------	--	-------------	-------------	-------------	----	--------	--------	-----

**Veneer species must be noted on each line item**

Top with profile edge detail, finished wood panel. Open project shelf storage 3" high. Cabinet back unfinished. Optional task lights available, see HBF Casegood Accessories.

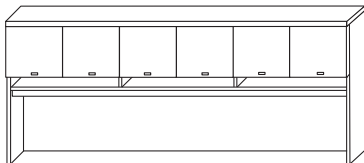

<b>ME63F-FWP</b>		<b>4877</b>	<b>5267</b>	<b>5852</b>	78	15 3/4	43 5/8	289
<b>ME63B-FWP</b>		<b>4836</b>	<b>5223</b>	<b>5803</b>	84	15 3/4	43 5/8	296
<b>ME63C-FWP</b>		<b>5320</b>	<b>5746</b>	<b>6384</b>	90	15 3/4	43 5/8	339
<b>ME63D-FWP</b>		<b>5536</b>	<b>5979</b>	<b>6644</b>	96	15 3/4	43 5/8	351
<b>ME63G-FWP</b>		<b>5773</b>	<b>6235</b>	<b>6928</b>	102	15 3/4	43 5/8	365
<b>ME63E-FWP</b>		<b>5979</b>	<b>6457</b>	<b>7175</b>	108	15 3/4	43 5/8	376
<b>ME63H-FWP</b>		<b>6165</b>	<b>6658</b>	<b>7397</b>	114	15 3/4	43 5/8	391
<b>ME63J-FWP</b>		<b>6350</b>	<b>6858</b>	<b>7620</b>	120	15 3/4	43 5/8	406

**Veneer species must be noted on each line item**

Top with profile edge detail, finished wood panel. Open project shelf storage 3" high. Cabinet back unfinished. Optional task lights available, see HBF Casegood Accessories.

**Veneer species must be noted on each line item**

<u>Veneer Grade 1</u>	<u>Veneer Grade 2</u>	<u>Veneer Grade 3</u>
Cherry	Rift Oak	Anigre
Maple	Sapele	
Ligno-Grain		
Walnut		

# HBF Mercer Casegoods - Overhead Cabinets

Style Number	Fabric	List Price			Dimensions			Weight
		Veneer 1	Veneer 2	Veneer 3	OW	OD	OH	

## Overhead Cabinets, Top with Profile Edge Detail, Wood Panel Support

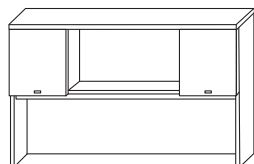

<b>ME62A-PNP</b>	3 yds	<b>3466</b>	<b>3743</b>	<b>4159</b>	72	15 3/4	43 5/8	282
------------------	-------	-------------	-------------	-------------	----	--------	--------	-----

**Veneer species must be noted on each line item**

Top with profile edge detail, fabric tack panel (fabric not included, COM must be acrylic backed). Open center storage. Cabinet back unfinished. Optional task lights available, see HBF Casegood Accessories.

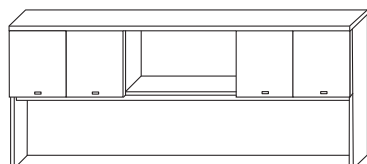

<b>ME62F-PNP</b>	3 yds	<b>3960</b>	<b>4277</b>	<b>4752</b>	78	15 3/4	43 5/8	289
<b>ME62B-PNP</b>	3 yds	<b>4146</b>	<b>4477</b>	<b>4975</b>	84	15 3/4	43 5/8	296
<b>ME62C-PNP</b>	3 yds	<b>4321</b>	<b>4667</b>	<b>5185</b>	90	15 3/4	43 5/8	339
<b>ME62D-PNP</b>	3 1/4 yds	<b>4496</b>	<b>4856</b>	<b>5395</b>	96	15 3/4	43 5/8	351
<b>ME62G-PNP</b>	3 1/2 yds	<b>4681</b>	<b>5056</b>	<b>5618</b>	102	15 3/4	43 5/8	365
<b>ME62E-PNP</b>	3 3/4 yds	<b>4856</b>	<b>5245</b>	<b>5828</b>	108	15 3/4	43 5/8	376
<b>ME62H-PNP</b>	4 1/4 yds	<b>5042</b>	<b>5445</b>	<b>6050</b>	114	15 3/4	43 5/8	391
<b>ME62J-PNP</b>	4 1/4 yds	<b>5227</b>	<b>5645</b>	<b>6273</b>	120	15 3/4	43 5/8	406

**Veneer species must be noted on each line item**

Top with profile edge detail, fabric tack panel (fabric not included, COM must be acrylic backed). Open center storage. Cabinet back unfinished. Optional task lights available, see HBF Casegood Accessories.

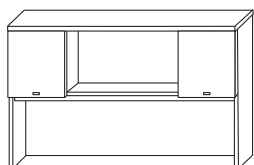

<b>ME63A-PNP</b>		<b>3693</b>	<b>3988</b>	<b>4431</b>	72	15 3/4	43 5/8	282
------------------	--	-------------	-------------	-------------	----	--------	--------	-----

**Veneer species must be noted on each line item**

Top with profile edge detail, finished wood panel. Open center storage. Cabinet back unfinished. Optional task lights available, see HBF Casegood Accessories.

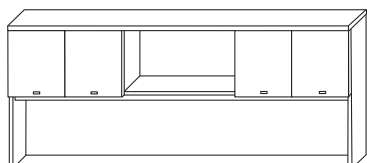

<b>ME63F-PNP</b>		<b>4208</b>	<b>4544</b>	<b>5049</b>	78	15 3/4	43 5/8	289
<b>ME63B-PNP</b>		<b>4414</b>	<b>4767</b>	<b>5296</b>	84	15 3/4	43 5/8	296
<b>ME63C-PNP</b>		<b>4589</b>	<b>4956</b>	<b>5506</b>	90	15 3/4	43 5/8	339
<b>ME63D-PNP</b>		<b>4784</b>	<b>5167</b>	<b>5741</b>	96	15 3/4	43 5/8	351
<b>ME63G-PNP</b>		<b>4990</b>	<b>5390</b>	<b>5988</b>	102	15 3/4	43 5/8	365
<b>ME63E-PNP</b>		<b>5165</b>	<b>5579</b>	<b>6199</b>	108	15 3/4	43 5/8	376
<b>ME63H-PNP</b>		<b>5351</b>	<b>5779</b>	<b>6421</b>	114	15 3/4	43 5/8	391
<b>ME63J-PNP</b>		<b>5536</b>	<b>5979</b>	<b>6644</b>	120	15 3/4	43 5/8	406

**Veneer species must be noted on each line item**

Top with profile edge detail, finished wood panel. Open center storage. Cabinet back unfinished. Optional task lights available, see HBF Casegood Accessories.

**Veneer species must be noted on each line item**

<u>Veneer Grade 1</u>	<u>Veneer Grade 2</u>	<u>Veneer Grade 3</u>
Cherry	Rift Oak	Anigre
Maple	Sapele	
Ligno-Grain		
Walnut		

# HBF Mercer Casegoods - Overhead Cabinets

Style Number	Fabric	List Price			Dimensions			Weight
		Veneer 1	Veneer 2	Veneer 3	OW	OD	OH	

## Overhead Cabinets, Top with Profile Edge Detail, Wood Panel Support

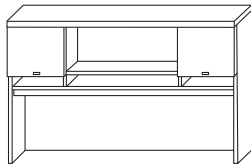

<b>ME62A-PWP</b>	3 yds	<b>3826</b>	<b>4133</b>	<b>4592</b>	72	15 3/4	43 5/8	282
------------------	-------	-------------	-------------	-------------	----	--------	--------	-----

**Veneer species must be noted on each line item**

Top with profile edge detail, fabric tack panel (fabric not included, COM must be acrylic backed). Open project shelf storage and open center storage 3" high. Cabinet back unfinished. Optional task lights available, see HBF Casegood Accessories.

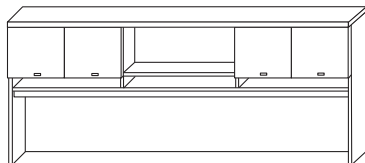

<b>ME62F-PWP</b>	3 yds	<b>4383</b>	<b>4733</b>	<b>5259</b>	78	15 3/4	43 5/8	289
<b>ME62B-PWP</b>	3 yds	<b>4589</b>	<b>4956</b>	<b>5506</b>	84	15 3/4	43 5/8	296
<b>ME62C-PWP</b>	3 yds	<b>4774</b>	<b>5156</b>	<b>5729</b>	90	15 3/4	43 5/8	339
<b>ME62D-PWP</b>	3 1/4 yds	<b>4970</b>	<b>5367</b>	<b>5964</b>	96	15 3/4	43 5/8	351
<b>ME62G-PWP</b>	3 1/2 yds	<b>5176</b>	<b>5590</b>	<b>6211</b>	102	15 3/4	43 5/8	365
<b>ME62E-PWP</b>	3 3/4 yds	<b>5371</b>	<b>5801</b>	<b>6446</b>	108	15 3/4	43 5/8	376
<b>ME62H-PWP</b>	4 1/4 yds	<b>5557</b>	<b>6001</b>	<b>6668</b>	114	15 3/4	43 5/8	391
<b>ME62J-PWP</b>	4 1/4 yds	<b>5742</b>	<b>6202</b>	<b>6891</b>	120	15 3/4	43 5/8	406

**Veneer species must be noted on each line item**

Top with profile edge detail, fabric tack panel (fabric not included, COM must be acrylic backed). Open project shelf storage and open center storage 3" high. Cabinet back unfinished. Optional task lights available, see HBF Casegood Accessories.

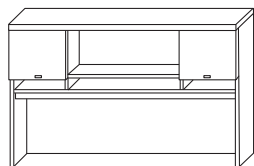

<b>ME63A-PWP</b>		<b>4084</b>	<b>4411</b>	<b>4901</b>	72	15 3/4	43 5/8	282
------------------	--	-------------	-------------	-------------	----	--------	--------	-----

**Veneer species must be noted on each line item**

Top with profile edge detail, finished wood panel. Open project shelf storage and open center storage 3" high. Cabinet back unfinished. Optional task lights available, see HBF Casegood Accessories.

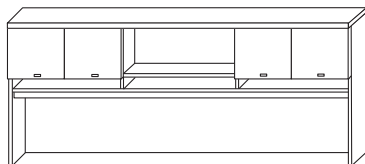

<b>ME63F-PWP</b>		<b>4650</b>	<b>5022</b>	<b>5581</b>	78	15 3/4	43 5/8	289
<b>ME63B-PWP</b>		<b>4877</b>	<b>5267</b>	<b>5852</b>	84	15 3/4	43 5/8	296
<b>ME63C-PWP</b>		<b>5073</b>	<b>5479</b>	<b>6087</b>	90	15 3/4	43 5/8	339
<b>ME63D-PWP</b>		<b>5289</b>	<b>5712</b>	<b>6347</b>	96	15 3/4	43 5/8	351
<b>ME63G-PWP</b>		<b>5516</b>	<b>5957</b>	<b>6619</b>	102	15 3/4	43 5/8	365
<b>ME63E-PWP</b>		<b>5711</b>	<b>6168</b>	<b>6854</b>	108	15 3/4	43 5/8	376
<b>ME63H-PWP</b>		<b>5897</b>	<b>6368</b>	<b>7076</b>	114	15 3/4	43 5/8	391
<b>ME63J-PWP</b>		<b>6082</b>	<b>6569</b>	<b>7299</b>	120	15 3/4	43 5/8	406

**Veneer species must be noted on each line item**

Top with profile edge detail, finished wood panel. Open project shelf storage and open center storage 3" high. Cabinet back unfinished. Optional task lights available, see HBF Casegood Accessories.

**Veneer species must be noted on each line item**

<u>Veneer Grade 1</u>	<u>Veneer Grade 2</u>	<u>Veneer Grade 3</u>
Cherry	Rift Oak	Anigre
Maple	Sapele	
Ligno-Grain		
Walnut		



# HBF Mercer Casegoods - Overhead Cabinets

Style Number	Fabric	List Price			Dimensions			Weight
		Veneer 1	Veneer 2	Veneer 3	OW	OD	OH	

## Overhead Cabinets, Top with Profile Edge Detail, Wood Panel Support (Double High)

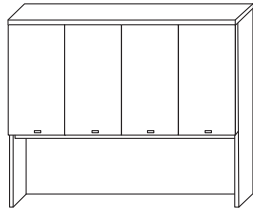

ME62A2-FNP	3 yds	4929	5323	5914	72	15 3/4	57 3/8	282
------------	-------	------	------	------	----	--------	--------	-----

Veneer species must be noted on each line item

Top with profile edge detail, one adjustable shelf, fabric tack panel (fabric not included, COM must be acrylic backed). Cabinet back unfinished. Optional task lights available, see HBF Casegood Accessories.

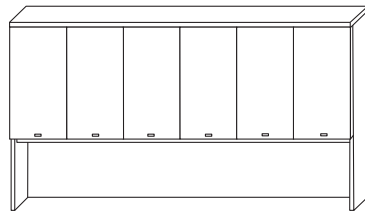

ME62F2-FNP	3 yds	5639	6090	6767	78	15 3/4	57 3/8	289
ME62B2-FNP	3 yds	5897	6368	7076	84	15 3/4	57 3/8	296
ME62C2-FNP	3 yds	6144	6635	7373	90	15 3/4	57 3/8	339
ME62D2-FNP	3 1/4 yds	6401	6914	7682	96	15 3/4	57 3/8	351
ME62G2-FNP	3 1/2 yds	6659	7192	7991	102	15 3/4	57 3/8	365
ME62E2-FNP	3 3/4 yds	6906	7459	8287	108	15 3/4	57 3/8	376
ME62H2-FNP	4 1/4 yds	7143	7714	8572	114	15 3/4	57 3/8	391
ME62J2-FNP	4 1/4 yds	7380	7970	8856	120	15 3/4	57 3/8	406

Veneer species must be noted on each line item

Top with profile edge detail, one adjustable shelf, fabric tack panel (fabric not included, COM must be acrylic backed). Cabinet back unfinished. Optional task lights available, see HBF Casegood Accessories.

## Overhead Cabinets, Top with Profile Edge Detail, Wood Panel Support

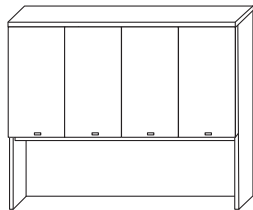

ME63A2-FNP		5258	5679	6310	72	15 3/4	57 3/8	312
------------	--	------	------	------	----	--------	--------	-----

Veneer species must be noted on each line item

Top with profile edge detail, one adjustable shelf, finished wood panel. Cabinet back unfinished. Optional task lights available, see HBF Casegood Accessories.

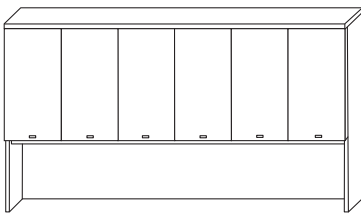

ME63F2-FNP		5989	6469	7187	78	15 3/4	57 3/8	319
ME63B2-FNP		6278	6780	7533	84	15 3/4	57 3/8	326
ME63C2-FNP		6535	7058	7842	90	15 3/4	57 3/8	379
ME63D2-FNP		6803	7347	8164	96	15 3/4	57 3/8	391
ME63G2-FNP		7092	7659	8510	102	15 3/4	57 3/8	405
ME63E2-FNP		7349	7937	8819	108	15 3/4	57 3/8	416
ME63H2-FNP		7586	8193	9103	114	15 3/4	57 3/8	441
ME63J2-FNP		7823	8449	9387	120	15 3/4	57 3/8	456

Veneer species must be noted on each line item

Top with profile edge detail, one adjustable shelf, finished wood panel, Cabinet back unfinished. Optional task lights available, see HBF Casegood Accessories.

Double high overhead cabinets to be used with double high vertical cabinets.

Veneer species must be noted on each line item

Veneer Grade 1	Veneer Grade 2	Veneer Grade 3
Cherry	Rift Oak	Anigre
Maple	Sapele	
Ligno-Grain		
Walnut		

# HBF Mercer Casegoods - Overhead Cabinets

Style Number	Fabric	List Price			Dimensions			Weight
		Veneer 1	Veneer 2	Veneer 3	OW	OD	OH	

## Overhead Cabinets, Top with Profile Edge Detail, Wood Panel Support (Double High)

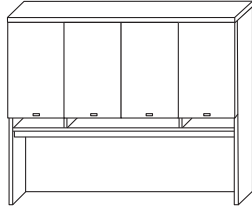

ME62A2-FWP	3 yds	5423	5857	6508	72	15 3/4	57 3/8	312
------------	-------	------	------	------	----	--------	--------	-----

Veneer species must be noted on each line item

Top with profile edge detail, one adjustable shelf, fabric tack panel, (fabric not included, COM must be acrylic backed). Open project shelf storage 3" high. Cabinet back unfinished. Optional task lights available, see HBF Casegood Accessories.

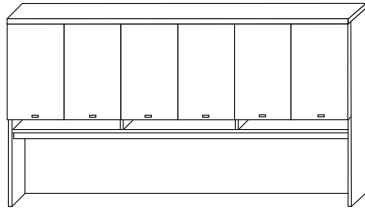

ME62F2-FWP	3 yds	6195	6691	7435	78	15 3/4	57 3/8	319
ME62B2-FWP	3 yds	6494	7014	7793	84	15 3/4	57 3/8	326
ME62C2-FWP	3 yds	6762	7303	8114	90	15 3/4	57 3/8	379
ME62D2-FWP	3 1/4 yds	7040	7603	8448	96	15 3/4	57 3/8	391
ME62G2-FWP	3 1/2 yds	7328	7915	8794	102	15 3/4	57 3/8	405
ME62E2-FWP	3 3/4 yds	7596	8204	9116	108	15 3/4	57 3/8	416
ME62H2-FWP	4 1/4 yds	7833	8460	9400	114	15 3/4	57 3/8	441
ME62J2-FWP	4 1/4 yds	8070	8716	9684	120	15 3/4	57 3/8	456

Veneer species must be noted on each line item

Top with profile edge detail, one adjustable shelf, fabric tack panel, (fabric not included, COM must be acrylic backed). Open project shelf storage 3" high. Cabinet back unfinished. Optional task lights available, see HBF Casegood Accessories.

## Overhead Cabinets, Top with Profile Edge Detail, Wood Panel Support

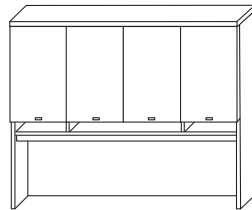

ME63A2-FWP		5783	6246	6940	72	15 3/4	57 3/8	312
------------	--	------	------	------	----	--------	--------	-----

Veneer species must be noted on each line item

Top with profile edge detail, one adjustable shelf, finished wood panel. Open project shelf storage 3" high. Cabinet back unfinished. Optional task lights available, see HBF Casegood Accessories.

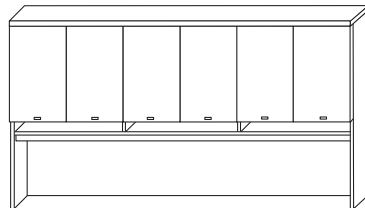

ME63F2-FWP		6587	7114	7904	78	15 3/4	57 3/8	319
ME63B2-FWP		6906	7459	8257	84	15 3/4	57 3/8	326
ME63C2-FWP		7184	7759	8621	90	15 3/4	57 3/8	379
ME63D2-FWP		7483	8082	8980	96	15 3/4	57 3/8	391
ME63G2-FWP		7802	8426	9363	102	15 3/4	57 3/8	405
ME63E2-FWP		8080	8727	9696	108	15 3/4	57 3/8	416
ME63H2-FWP		8317	8983	9981	114	15 3/4	57 3/8	441
ME63J2-FWP		8554	9238	10265	120	15 3/4	57 3/8	456

Veneer species must be noted on each line item

Top with profile edge detail, one adjustable shelf, finished wood panel. Open project shelf storage 3" high. Cabinet back unfinished. Optional task lights available, see HBF Casegood Accessories.

Double high overhead cabinets to be used with double high vertical cabinets.

Veneer species must be noted on each line item

Veneer Grade 1	Veneer Grade 2	Veneer Grade 3
Cherry	Rift Oak	Anigre
Maple	Sapele	
Ligno-Grain		
Walnut		

# HBF Mercer Casegoods - Overhead Cabinets

Style Number	Fabric	List Price			Dimensions			Weight
		Veneer 1	Veneer 2	Veneer 3	OW	OD	OH	

**Overhead Cabinets, Top with Profile Edge Detail, Wood Panel Support (Double High)**

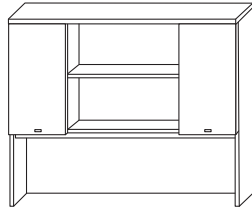

ME62A2-PNP	3 yds	4681	5056	5618	72	15 3/4	57 3/8	312
------------	-------	------	------	------	----	--------	--------	-----

**Veneer species must be noted on each line item**

Top with profile edge detail, fabric tack panel (fabric not included, COM must be acrylic backed). Open center storage, one adjustable shelf. Cabinet back unfinished. Optional task lights available, see HBF Casegood Accessories.

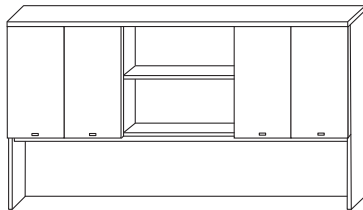

ME62F2-PNP	3 yds	5361	5790	6433	78	15 3/4	57 3/8	319
ME62B2-PNP	3 yds	5608	6057	6730	84	15 3/4	57 3/8	326
ME62C2-PNP	3 yds	5845	6313	7014	90	15 3/4	57 3/8	379
ME62D2-PNP	3 1/4 yds	6082	6569	7299	96	15 3/4	57 3/8	391
ME62G2-PNP	3 1/2 yds	6329	6836	7595	102	15 3/4	57 3/8	405
ME62E2-PNP	3 3/4 yds	6566	7092	7880	108	15 3/4	57 3/8	416
ME62H2-PNP	4 1/4 yds	6830	7347	8164	114	15 3/4	57 3/8	441
ME62J2-PNP	4 1/4 yds	7040	7603	8448	120	15 3/4	57 3/8	456

**Veneer species must be noted on each line item**

Top with profile edge detail, fabric tack panel (fabric not included, COM must be acrylic backed). Open center storage, one adjustable shelf. Cabinet back unfinished. Optional task lights available, see HBF Casegood Accessories.

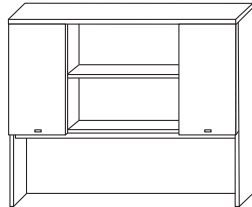

ME63A2-PNP		4990	5390	5988	72	15 3/4	57 3/8	312
------------	--	------	------	------	----	--------	--------	-----

**Veneer species must be noted on each line item**

Top with profile edge detail, finished wood panel. Open center storage, one adjustable shelf. Cabinet back unfinished. Optional task lights available, see HBF Casegood Accessories.

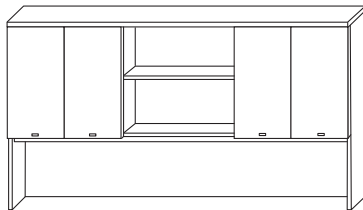

ME63F2-PNP		5691	6146	6829	78	15 3/4	57 3/8	319
ME63B2-PNP		5959	6435	7150	84	15 3/4	57 3/8	326
ME63C2-PNP		6206	6702	7447	90	15 3/4	57 3/8	379
ME63D2-PNP		6463	6980	7756	96	15 3/4	57 3/8	391
ME63G2-PNP		6741	7281	8090	102	15 3/4	57 3/8	405
ME63E2-PNP		6978	7537	8374	108	15 3/4	57 3/8	416
ME63H2-PNP		7215	7792	8658	114	15 3/4	57 3/8	441
ME63J2-PNP		7452	8048	8942	120	15 3/4	57 3/8	456

**Veneer species must be noted on each line item**

Top with profile edge detail, finished wood panel. Open center storage, one adjustable shelf. Cabinet back unfinished. Optional task lights available, see HBF Casegood Accessories.

**Double high overhead cabinets to be used with double high vertical cabinets.**

**Veneer species must be noted on each line item**

<u>Veneer Grade 1</u>	<u>Veneer Grade 2</u>	<u>Veneer Grade 3</u>
Cherry	Rift Oak	Anigre
Maple	Sapele	
Ligno-Grain		
Walnut		

# HBF Mercer Casegoods - Overhead Cabinets

Style Number	Fabric	List Price			Dimensions			Weight
		Veneer 1	Veneer 2	Veneer 3	OW	OD	OH	

## Overhead Cabinets, Top with Profile Edge Detail, Wood Panel Support (Double High)

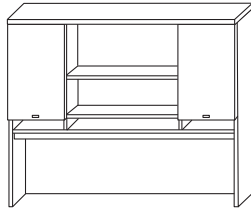

ME62A2-PWP	3 yds	5176	5590	6211	72	15 3/4	57 3/8	312
------------	-------	------	------	------	----	--------	--------	-----

**Veneer species must be noted on each line item**

Top with profile edge detail, fabric tack panel (fabric not included, COM must be acrylic backed). Open center storage, one adjustable shelf, open project shelf storage 3" high. Cabinet back unfinished. Optional task lights available, see HBF Casegood Accessories.

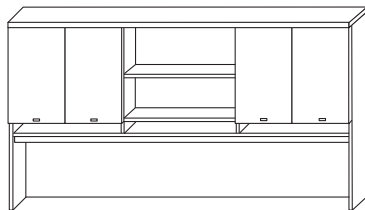

ME62F2-PWP	3 yds	5917	6391	7101	78	15 3/4	57 3/8	319
ME62B2-PWP	3 yds	6195	6691	7435	84	15 3/4	57 3/8	326
ME62C2-PWP	3 yds	6453	6969	7744	90	15 3/4	57 3/8	379
ME62D2-PWP	3 1/4 yds	6721	7258	8065	96	15 3/4	57 3/8	391
ME62G2-PWP	3 1/2 yds	6989	7548	8386	102	15 3/4	57 3/8	405
ME62E2-PWP	3 3/4 yds	7256	7837	8708	108	15 3/4	57 3/8	416
ME62H2-PWP	4 1/4 yds	7493	8093	8992	114	15 3/4	57 3/8	441
ME62J2-PWP	4 1/4 yds	7730	8349	9276	120	15 3/4	57 3/8	456

**Veneer species must be noted on each line item**

Top with profile edge detail, fabric tack panel (fabric not included, COM must be acrylic backed). Open center storage, one adjustable shelf, open project shelf storage 3" high. Cabinet back unfinished. Optional task lights available, see HBF Casegood Accessories.

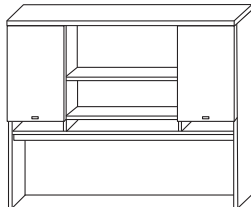

ME63A2-PWP		5516	5957	6619	72	15 3/4	57 3/8	312
------------	--	------	------	------	----	--------	--------	-----

**Veneer species must be noted on each line item**

Top with profile edge detail, finished wood panel. Open center storage, one adjustable shelf, open project shelf storage 3" high. Cabinet back unfinished. Optional task lights available, see HBF Casegood Accessories.

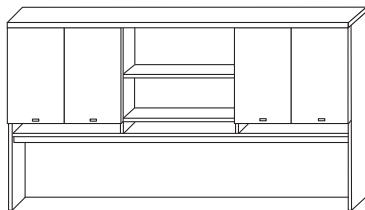

ME63F2-PWP		6288	6791	7546	78	15 3/4	57 3/8	319
ME63B2-PWP		6597	7125	7917	84	15 3/4	57 3/8	326
ME63C2-PWP		6865	7414	8238	90	15 3/4	57 3/8	379
ME63D2-PWP		7143	7714	8572	96	15 3/4	57 3/8	391
ME63G2-PWP		7452	8048	8942	102	15 3/4	57 3/8	405
ME63E2-PWP		7720	8337	9264	108	15 3/4	57 3/8	416
ME63H2-PWP		7957	8593	9548	114	15 3/4	57 3/8	441
ME63J2-PWP		8194	8849	9832	120	15 3/4	57 3/8	456

**Veneer species must be noted on each line item**

Top with profile edge detail, finished wood panel. Open center storage, one adjustable shelf, open project shelf storage 3" high. Cabinet back unfinished. Optional task lights available, see HBF Casegood Accessories.

**Double high overhead cabinets to be used with double high vertical cabinets.**

**Veneer species must be noted on each line item**

Veneer Grade 1	Veneer Grade 2	Veneer Grade 3
Cherry	Rift Oak	Anigre
Maple	Sapele	
Ligno-Grain		
Walnut		

# HBF Mercer Casegoods - Overhead Cabinets

Style Number	Fabric	List Price			Dimensions			Weight
		Veneer 1	Veneer 2	Veneer 3	OW	OD	OH	

## Overhead Cabinets, Top without Profile Edge Detail

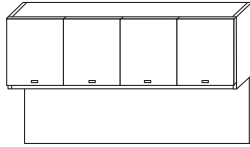

<b>ME64M-FNP</b>	3 yds	<b>3178</b>	<b>3432</b>	<b>3813</b>	72	15 3/4	42 1/4	195
------------------	-------	-------------	-------------	-------------	----	--------	--------	-----

**Veneer species must be noted on each line item**

Wall mount, flush top without profile edge detail, fabric tack panel (fabric not included, COM must be acrylic backed), cabinet back unfinished. Optional task lights available, see HBF Casegood Accessories.

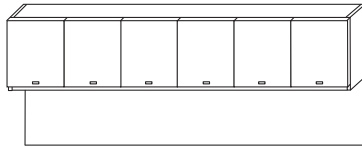

<b>ME64N-FNP</b>	3 yds	<b>3651</b>	<b>3943</b>	<b>4382</b>	78	15 3/4	42 1/4	215
<b>ME64P-FNP</b>	3 yds	<b>3837</b>	<b>4144</b>	<b>4604</b>	84	15 3/4	42 1/4	215
<b>ME64R-FNP</b>	3 yds	<b>4002</b>	<b>4322</b>	<b>4802</b>	90	15 3/4	42 1/4	225
<b>ME64S-FNP</b>	3 1/4 yds	<b>4177</b>	<b>4511</b>	<b>5012</b>	96	15 3/4	42 1/4	225
<b>ME64T-FNP</b>	3 1/2 yds	<b>4362</b>	<b>4711</b>	<b>5234</b>	102	15 3/4	42 1/4	235
<b>ME64U-FNP</b>	3 3/4 yds	<b>4527</b>	<b>4889</b>	<b>5432</b>	108	15 3/4	42 1/4	235
<b>ME64V-FNP</b>	4 1/4 yds	<b>4712</b>	<b>5089</b>	<b>5655</b>	114	15 3/4	42 1/4	245
<b>ME64W-FNP</b>	4 1/4 yds	<b>4898</b>	<b>5289</b>	<b>5877</b>	120	15 3/4	42 1/4	245

**Veneer species must be noted on each line item**

Wall mount, flush top without profile edge detail, fabric tack panel (fabric not included, COM must be acrylic backed), cabinet back unfinished. Optional task lights available, see HBF Casegood Accessories.

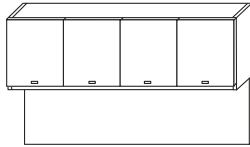

<b>ME65M-FNP</b>		<b>3394</b>	<b>3665</b>	<b>4073</b>	72	15 3/4	42 1/4	195
------------------	--	-------------	-------------	-------------	----	--------	--------	-----

**Veneer species must be noted on each line item**

Wall mount, flush top without profile edge detail, finished wood panel, cabinet back unfinished. Optional task lights available, see HBF Casegood Accessories.

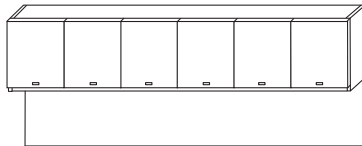

<b>ME65N-FNP</b>		<b>3899</b>	<b>4210</b>	<b>4678</b>	78	15 3/4	42 1/4	215
<b>ME65P-FNP</b>		<b>4094</b>	<b>4422</b>	<b>4913</b>	84	15 3/4	42 1/4	215
<b>ME65R-FNP</b>		<b>4269</b>	<b>4611</b>	<b>5123</b>	90	15 3/4	42 1/4	225
<b>ME65S-FNP</b>		<b>4455</b>	<b>4811</b>	<b>5346</b>	96	15 3/4	42 1/4	225
<b>ME65T-FNP</b>		<b>4650</b>	<b>5022</b>	<b>5581</b>	102	15 3/4	42 1/4	235
<b>ME65U-FNP</b>		<b>4826</b>	<b>5212</b>	<b>5791</b>	108	15 3/4	42 1/4	235
<b>ME65V-FNP</b>		<b>5011</b>	<b>5412</b>	<b>6013</b>	114	15 3/4	42 1/4	245
<b>ME65W-FNP</b>		<b>5196</b>	<b>5612</b>	<b>6236</b>	120	15 3/4	42 1/4	245

**Veneer species must be noted on each line item**

Wall mount, flush top without profile edge detail, finished wood panel, cabinet back unfinished. Optional task lights available, see HBF Casegood Accessories.

**Installation and maintenance of wall mounted overhead cabinets are the sole responsibility of the customer. Proper installation is crucial to prevent personal injury.**

**Veneer species must be noted on each line item**

<u>Veneer Grade 1</u>	<u>Veneer Grade 2</u>	<u>Veneer Grade 3</u>
Cherry	Rift Oak	Anigre
Maple	Sapele	
Ligno-Grain		
Walnut		

# HBF Mercer Casegoods - Overhead Cabinets

Style Number	Fabric	List Price			Dimensions			Weight
		Veneer 1	Veneer 2	Veneer 3	OW	OD	OH	

## Overhead Cabinets, Top without Profile Edge Detail

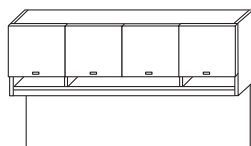

<b>ME64M-FWP</b>	3 yds	<b>3517</b>	<b>3799</b>	<b>4221</b>	72	15 3/4	42 1/4	195
------------------	-------	-------------	-------------	-------------	----	--------	--------	-----

**Veneer species must be noted on each line item**

Wall mount, flush top without profile edge detail, fabric tack panel (fabric not included, COM must be acrylic backed). Open project shelf storage 3" high. Cabinet back unfinished. Optional task lights available, see HBF Casegood Accessories.

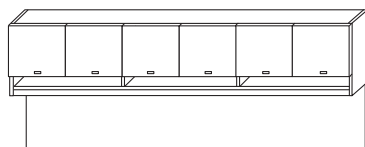

<b>ME64N-FWP</b>	3 yds	<b>4043</b>	<b>4366</b>	<b>4851</b>	78	15 3/4	42 1/4	215
<b>ME64P-FWP</b>	3 yds	<b>4238</b>	<b>4578</b>	<b>5086</b>	84	15 3/4	42 1/4	215
<b>ME64R-FWP</b>	3 yds	<b>4424</b>	<b>4778</b>	<b>5309</b>	90	15 3/4	42 1/4	225
<b>ME64S-FWP</b>	3 1/4 yds	<b>4620</b>	<b>4989</b>	<b>5543</b>	96	15 3/4	42 1/4	225
<b>ME64T-FWP</b>	3 1/2 yds	<b>4815</b>	<b>5200</b>	<b>5778</b>	102	15 3/4	42 1/4	235
<b>ME64U-FWP</b>	3 3/4 yds	<b>5001</b>	<b>5401</b>	<b>6001</b>	108	15 3/4	42 1/4	235
<b>ME64V-FWP</b>	4 1/4 yds	<b>5186</b>	<b>5601</b>	<b>6223</b>	114	15 3/4	42 1/4	245
<b>ME64W-FWP</b>	4 1/4 yds	<b>5371</b>	<b>5801</b>	<b>6446</b>	120	15 3/4	42 1/4	245

**Veneer species must be noted on each line item**

Wall mount, flush top without profile edge detail, fabric tack panel (fabric not included, COM must be acrylic backed). Open project shelf storage 3" high. Cabinet back unfinished. Optional task lights available, see HBF Casegood Accessories.

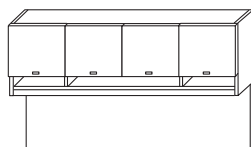

<b>ME65M-FWP</b>		<b>3754</b>	<b>4055</b>	<b>4505</b>	72	15 3/4	42 1/4	195
------------------	--	-------------	-------------	-------------	----	--------	--------	-----

**Veneer species must be noted on each line item**

Wall mount, flush top without profile edge detail, finished wood panel. Open project shelf storage 3" high. Cabinet back unfinished. Optional task lights available, see HBF Casegood Accessories.

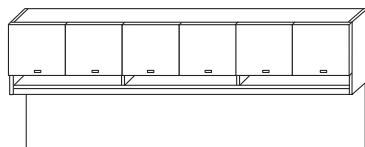

<b>ME65N-FWP</b>		<b>4311</b>	<b>4655</b>	<b>5173</b>	78	15 3/4	42 1/4	215
<b>ME65P-FWP</b>		<b>4527</b>	<b>4889</b>	<b>5432</b>	84	15 3/4	42 1/4	215
<b>ME65R-FWP</b>		<b>4723</b>	<b>5100</b>	<b>5667</b>	90	15 3/4	42 1/4	225
<b>ME65S-FWP</b>		<b>4929</b>	<b>5323</b>	<b>5914</b>	96	15 3/4	42 1/4	225
<b>ME65T-FWP</b>		<b>5145</b>	<b>5556</b>	<b>6174</b>	102	15 3/4	42 1/4	235
<b>ME65U-FWP</b>		<b>5330</b>	<b>5757</b>	<b>6396</b>	108	15 3/4	42 1/4	235
<b>ME65V-FWP</b>		<b>5516</b>	<b>5957</b>	<b>6619</b>	114	15 3/4	42 1/4	245
<b>ME65W-FWP</b>		<b>5701</b>	<b>6157</b>	<b>6841</b>	120	15 3/4	42 1/4	245

**Veneer species must be noted on each line item**

Wall mount, flush top without profile edge detail, finished wood panel. Open project shelf storage 3" high. Cabinet back unfinished. Optional task lights available, see HBF Casegood Accessories.

**Installation and maintenance of wall mounted overhead cabinets are the sole responsibility of the customer. Proper installation is crucial to prevent personal injury.**

**Veneer species must be noted on each line item**

<u>Veneer Grade 1</u>	<u>Veneer Grade 2</u>	<u>Veneer Grade 3</u>
Cherry	Rift Oak	Anigre
Maple	Sapele	
Ligno-Grain		
Walnut		

# HBF Mercer Casegoods - Overhead Cabinets

Style Number	Fabric	List Price			Dimensions			Weight
		Veneer 1	Veneer 2	Veneer 3	OW	OD	OH	

## Overhead Cabinets, Top without Profile Edge Detail

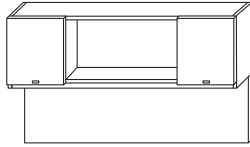

<b>ME64M-PNP</b>	3 yds	<b>3002</b>	<b>3243</b>	<b>3603</b>	72	15 3/4	42 1/4	189
------------------	-------	-------------	-------------	-------------	----	--------	--------	-----

**Veneer species must be noted on each line item**

Wall mount, flush top without profile edge detail, fabric tack panel (fabric not included, COM must be acrylic backed). Open center storage. Cabinet back unfinished. Optional task lights available, see HBF Casegood Accessories.

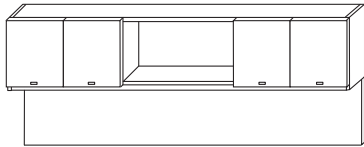

<b>ME64N-PNP</b>	3 yds	<b>3466</b>	<b>3743</b>	<b>4159</b>	78	15 3/4	42 1/4	205
<b>ME64P-PNP</b>	3 yds	<b>3631</b>	<b>3921</b>	<b>4357</b>	84	15 3/4	42 1/4	205
<b>ME64R-PNP</b>	3 yds	<b>3796</b>	<b>4099</b>	<b>4555</b>	90	15 3/4	42 1/4	215
<b>ME64S-PNP</b>	3 1/4 yds	<b>3960</b>	<b>4277</b>	<b>4752</b>	96	15 3/4	42 1/4	215
<b>ME64T-PNP</b>	3 1/2 yds	<b>4125</b>	<b>4455</b>	<b>4950</b>	102	15 3/4	42 1/4	225
<b>ME64U-PNP</b>	3 3/4 yds	<b>4290</b>	<b>4633</b>	<b>5148</b>	108	15 3/4	42 1/4	225
<b>ME64V-PNP</b>	4 1/4 yds	<b>4475</b>	<b>4833</b>	<b>5370</b>	114	15 3/4	42 1/4	235
<b>ME64W-PNP</b>	4 1/4 yds	<b>4661</b>	<b>5034</b>	<b>5593</b>	120	15 3/4	42 1/4	235

**Veneer species must be noted on each line item**

Wall mount, flush top without profile edge detail, fabric tack panel (fabric not included, COM must be acrylic backed). Open center storage. Cabinet back unfinished. Optional task lights available, see HBF Casegood Accessories.

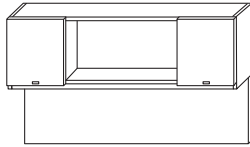

<b>ME65M-PNP</b>		<b>3219</b>	<b>3476</b>	<b>3863</b>	72	15 3/4	42 1/4	189
------------------	--	-------------	-------------	-------------	----	--------	--------	-----

**Veneer species must be noted on each line item**

Wall mount, flush top without profile edge detail, finished wood panel. Open center storage. Cabinet back unfinished. Optional task lights available, see HBF Casegood Accessories.

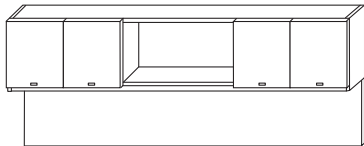

<b>ME65N-PNP</b>		<b>3693</b>	<b>3988</b>	<b>4431</b>	78	15 3/4	42 1/4	205
<b>ME65P-PNP</b>		<b>3878</b>	<b>4188</b>	<b>4654</b>	84	15 3/4	42 1/4	205
<b>ME65R-PNP</b>		<b>4043</b>	<b>4366</b>	<b>4851</b>	90	15 3/4	42 1/4	215
<b>ME65S-PNP</b>		<b>4228</b>	<b>4566</b>	<b>5074</b>	96	15 3/4	42 1/4	215
<b>ME65T-PNP</b>		<b>4414</b>	<b>4767</b>	<b>5296</b>	102	15 3/4	42 1/4	225
<b>ME65U-PNP</b>		<b>4578</b>	<b>4945</b>	<b>5494</b>	108	15 3/4	42 1/4	225
<b>ME65V-PNP</b>		<b>4764</b>	<b>5145</b>	<b>5717</b>	114	15 3/4	42 1/4	235
<b>ME65W-PNP</b>		<b>4949</b>	<b>5345</b>	<b>5939</b>	120	15 3/4	42 1/4	235

**Veneer species must be noted on each line item**

Wall mount, flush top without profile edge detail, finished wood panel. Open center storage. Cabinet back unfinished. Optional task lights available, see HBF Casegood Accessories.

**Installation and maintenance of wall mounted overhead cabinets are the sole responsibility of the customer. Proper installation is crucial to prevent personal injury.**

**Veneer species must be noted on each line item**

<u>Veneer Grade 1</u>	<u>Veneer Grade 2</u>	<u>Veneer Grade 3</u>
Cherry	Rift Oak	Anigre
Maple	Sapele	
Ligno-Grain		
Walnut		

# HBF Mercer Casegoods - Overhead Cabinets

Style Number	Fabric	List Price			Dimensions			Weight
		Veneer 1	Veneer 2	Veneer 3	OW	OD	OH	

## Overhead Cabinets, Top without Profile Edge Detail

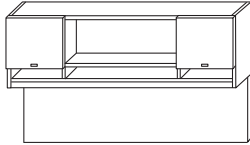

ME64M-PWP	3 yds	3342	3610	4011	72	15 3/4	42 1/4	189
-----------	-------	------	------	------	----	--------	--------	-----

**Veneer species must be noted on each line item**

Wall mount, flush top without profile edge detail, fabric tack panel (fabric not included, COM must be acrylic backed). Open project shelf storage 3" high and open center storage. Cabinet back unfinished. Optional task lights available, see HBF Casegood Accessories.

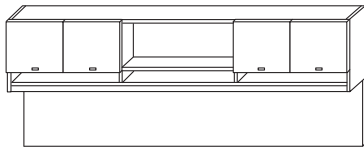

ME64N-PWP	3 yds	3847	4155	4616	78	15 3/4	42 1/4	205
ME64P-PWP	3 yds	4043	4366	4851	84	15 3/4	42 1/4	205
ME64R-PWP	3 yds	4218	4555	5061	90	15 3/4	42 1/4	215
ME64S-PWP	3 1/4 yds	4393	4744	5272	96	15 3/4	42 1/4	215
ME64T-PWP	3 1/2 yds	4589	4956	5506	102	15 3/4	42 1/4	225
ME64U-PWP	3 3/4 yds	4764	5145	5717	108	15 3/4	42 1/4	225
ME64V-PWP	4 1/4 yds	4949	5345	5939	114	15 3/4	42 1/4	235
ME64W-PWP	4 1/4 yds	5135	5545	6161	120	15 3/4	42 1/4	235

**Veneer species must be noted on each line item**

Wall mount, flush top without profile edge detail, fabric tack panel (fabric not included, COM must be acrylic backed). Open project shelf storage 3" high and open center storage. Cabinet back unfinished. Optional task lights available, see HBF Casegood Accessories.

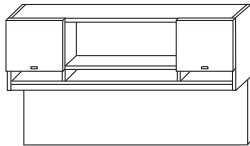

ME65M-PWP		3579	3866	4295	72	15 3/4	42 1/4	189
-----------	--	------	------	------	----	--------	--------	-----

**Veneer species must be noted on each line item**

Wall mount, flush top without profile edge detail, finished wood panel. Open project shelf storage 3" high and open center storage. Cabinet back unfinished. Optional task lights available, see HBF Casegood Accessories.

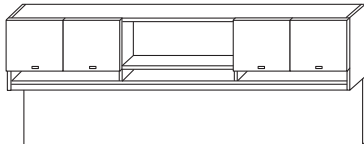

ME65N-PWP		4105	4433	4925	78	15 3/4	42 1/4	205
ME65P-PWP		4311	4655	5173	84	15 3/4	42 1/4	205
ME65R-PWP		4496	4856	5395	90	15 3/4	42 1/4	215
ME65S-PWP		4692	5067	5630	96	15 3/4	42 1/4	215
ME65T-PWP		4898	5289	5877	102	15 3/4	42 1/4	225
ME65U-PWP		5083	5490	6100	108	15 3/4	42 1/4	225
ME65V-PWP		5268	5690	6322	114	15 3/4	42 1/4	235
ME65W-PWP		5454	5890	6545	120	15 3/4	42 1/4	235

**Veneer species must be noted on each line item**

Wall mount, flush top without profile edge detail, finished wood panel. Open project shelf storage 3" high and open center storage. Cabinet back unfinished. Optional task lights available, see HBF Casegood Accessories.

**Installation and maintenance of wall mounted overhead cabinets are the sole responsibility of the customer. Proper installation is crucial to prevent personal injury.**

**Veneer species must be noted on each line item**

<u>Veneer Grade 1</u>	<u>Veneer Grade 2</u>	<u>Veneer Grade 3</u>
Cherry	Rift Oak	Anigre
Maple	Sapele	
Ligno-Grain		
Walnut		



# HBF Mercer Casegoods - Overhead Cabinets

Style Number	Fabric	List Price			Dimensions			Weight
		Veneer 1	Veneer 2	Veneer 3	OW	OD	OH	

## Overhead Cabinets, Top without Profile Edge Detail (Double High)

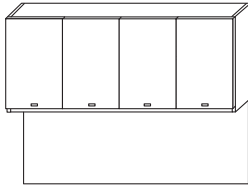

ME64M2-FNP	3 yds	4362	4711	5234	72	15 3/4	56	200
------------	-------	------	------	------	----	--------	----	-----

Veneer species must be noted on each line item

Wall mount, flush top without profile edge detail, one adjustable shelf, fabric tack panel (fabric not included, COM must be acrylic backed), cabinet back unfinished. Optional task lights available, see HBF Casegood Accessories.

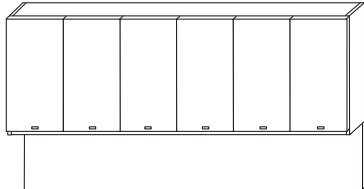

ME64N2-FNP	3 yds	5011	5412	6013	78	15 3/4	56	220
ME64P2-FNP	3 yds	5258	5679	6310	84	15 3/4	56	220
ME64R2-FNP	3 yds	5485	5924	6582	90	15 3/4	56	230
ME64S2-FNP	3 1/4 yds	5722	6179	6866	96	15 3/4	56	230
ME64T2-FNP	3 1/2 yds	5959	6435	7150	102	15 3/4	56	240
ME64U2-FNP	3 3/4 yds	6195	6691	7435	108	15 3/4	56	240
ME64V2-FNP	4 1/4 yds	6432	6947	7719	114	15 3/4	56	250
ME64W2-FNP	4 1/4 yds	6669	7203	8003	120	15 3/4	56	250

Veneer species must be noted on each line item

Wall mount, flush top without profile edge detail, one adjustable shelf, fabric tack panel (fabric not included, COM must be acrylic backed), cabinet back unfinished. Optional task lights available, see HBF Casegood Accessories.

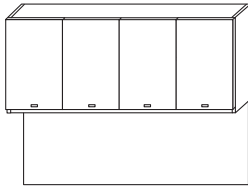

ME65M2-FNP		4661	5034	5593	72	15 3/4	56	200
------------	--	------	------	------	----	--------	----	-----

Veneer species must be noted on each line item

Wall mount, flush top without profile edge detail, one adjustable shelf, finished wood panel, cabinet back unfinished. Optional task lights available, see HBF Casegood Accessories.

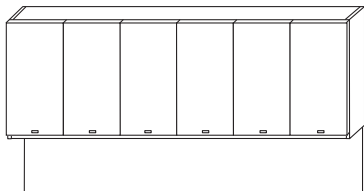

ME65N2-FNP		5341	5768	6409	78	15 3/4	56	220
ME65P2-FNP		5608	6057	6730	84	15 3/4	56	220
ME65R2-FNP		5845	6313	7014	90	15 3/4	56	230
ME65S2-FNP		6092	6580	7311	96	15 3/4	56	230
ME65T2-FNP		6360	6869	7632	102	15 3/4	56	240
ME65U2-FNP		6597	7125	7917	108	15 3/4	56	240
ME65V2-FNP		6834	7381	8201	114	15 3/4	56	250
ME65W2-FNP		7071	7637	8485	120	15 3/4	56	250

Veneer species must be noted on each line item

Wall mount, flush top without profile edge detail, one adjustable shelf, finished wood panel, cabinet back unfinished. Optional task lights available, see HBF Casegood Accessories.

**Double high overhead cabinets to be used with double high vertical cabinets.  
Installation and maintenance of wall mounted overhead cabinets are the sole responsibility of the customer.  
Proper installation is crucial to prevent personal injury.**

Veneer species must be noted on each line item

Veneer Grade 1	Veneer Grade 2	Veneer Grade 3
Cherry	Rift Oak	Anigre
Maple	Sapele	
Ligno-Grain		
Walnut		

# HBF Mercer Casegoods - Overhead Cabinets

Style Number	Fabric	List Price			Dimensions			Weight
		Veneer 1	Veneer 2	Veneer 3	OW	OD	OH	

## Overhead Cabinets, Top without Profile Edge Detail (Double High)

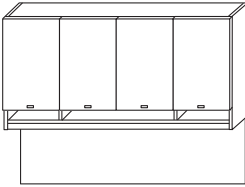

<b>ME64M2-FWP</b>	3 yds	<b>4815</b>	<b>5200</b>	<b>5778</b>	72	15 3/4	56	200
-------------------	-------	-------------	-------------	-------------	----	--------	----	-----

**Veneer species must be noted on each line item**

Wall mount, flush top without profile edge detail, one adjustable shelf, fabric tack panel (fabric not included, COM must be acrylic backed). Open project shelf storage 3" high. Cabinet back unfinished. Optional task lights available, see HBF Casegood Accessories.

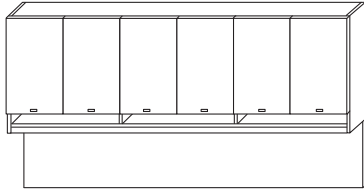

<b>ME64N2-FWP</b>	3 yds	<b>5536</b>	<b>5979</b>	<b>6644</b>	78	15 3/4	56	220
<b>ME64P2-FWP</b>	3 yds	<b>5804</b>	<b>6268</b>	<b>6965</b>	84	15 3/4	56	220
<b>ME64R2-FWP</b>	3 yds	<b>6051</b>	<b>6535</b>	<b>7262</b>	90	15 3/4	56	230
<b>ME64S2-FWP</b>	3 1/4 yds	<b>6309</b>	<b>6813</b>	<b>7571</b>	96	15 3/4	56	230
<b>ME64T2-FWP</b>	3 1/2 yds	<b>6577</b>	<b>7103</b>	<b>7892</b>	102	15 3/4	56	240
<b>ME64U2-FWP</b>	3 3/4 yds	<b>6834</b>	<b>7381</b>	<b>8201</b>	108	15 3/4	56	240
<b>ME64V2-FWP</b>	4 1/4 yds	<b>7071</b>	<b>7637</b>	<b>8485</b>	114	15 3/4	56	250
<b>ME64W2-FWP</b>	4 1/4 yds	<b>7308</b>	<b>7892</b>	<b>8769</b>	120	15 3/4	56	250

**Veneer species must be noted on each line item**

Wall mount, flush top without profile edge detail, one adjustable shelf, fabric tack panel (fabric not included, COM must be acrylic backed). Open project shelf storage 3" high. Cabinet back unfinished. Optional task lights available, see HBF Casegood Accessories.

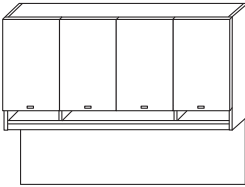

<b>ME65M2-FWP</b>		<b>5145</b>	<b>5556</b>	<b>6174</b>	72	15 3/4	56	200
-------------------	--	-------------	-------------	-------------	----	--------	----	-----

**Veneer species must be noted on each line item**

Wall mount, flush top without profile edge detail, one adjustable shelf, finished wood panel. Open project shelf storage 3" high. Cabinet back unfinished. Optional task lights available, see HBF Casegood Accessories.

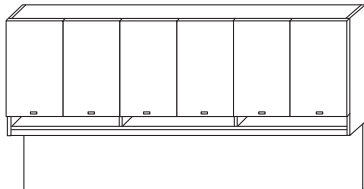

<b>ME65N2-FWP</b>		<b>5897</b>	<b>6368</b>	<b>7076</b>	78	15 3/4	56	220
<b>ME65P2-FWP</b>		<b>6185</b>	<b>6680</b>	<b>7422</b>	84	15 3/4	56	220
<b>ME65R2-FWP</b>		<b>6453</b>	<b>6969</b>	<b>7744</b>	90	15 3/4	56	230
<b>ME65S2-FWP</b>		<b>6721</b>	<b>7258</b>	<b>8065</b>	96	15 3/4	56	230
<b>ME65T2-FWP</b>		<b>7019</b>	<b>7581</b>	<b>8423</b>	102	15 3/4	56	240
<b>ME65U2-FWP</b>		<b>7277</b>	<b>7859</b>	<b>8732</b>	108	15 3/4	56	240
<b>ME65V2-FWP</b>		<b>7514</b>	<b>8115</b>	<b>9017</b>	114	15 3/4	56	250
<b>ME65W2-FWP</b>		<b>7751</b>	<b>8371</b>	<b>9301</b>	120	15 3/4	56	250

**Veneer species must be noted on each line item**

Wall mount, flush top without profile edge detail, one adjustable shelf, finished wood panel. Open project shelf storage 3" high. Cabinet back unfinished. Optional task lights available, see HBF Casegood Accessories.

**Double high overhead cabinets to be used with double high vertical cabinets.  
Installation and maintenance of wall mounted overhead cabinets are the sole responsibility of the customer.  
Proper installation is crucial to prevent personal injury.**

**Veneer species must be noted on each line item**

<u>Veneer Grade 1</u>	<u>Veneer Grade 2</u>	<u>Veneer Grade 3</u>
Cherry	Rift Oak	Anigre
Maple	Sapele	
Ligno-Grain		
Walnut		

# HBF Mercer Casegoods - Overhead Cabinets

Style Number	Fabric	List Price			Dimensions			Weight
		Veneer 1	Veneer 2	Veneer 3	OW	OD	OH	

## Overhead Cabinets, Top without Profile Edge Detail (Double High)

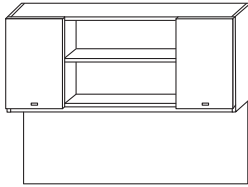

ME64M2-PNP	3 yds	4135	4466	4963	72	15 3/4	56	195
------------	-------	------	------	------	----	--------	----	-----

**Veneer species must be noted on each line item**

Wall mount, flush top without profile edge detail, fabric tack panel (fabric not included, COM must be acrylic backed). Open center storage, one adjustable shelf. Cabinet back unfinished. Optional task lights available, see HBF Casegood Accessories.

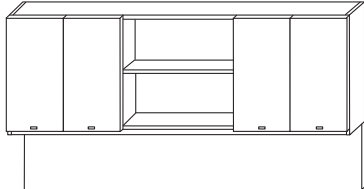

ME64N2-PNP	3 yds	4753	5134	5704	78	15 3/4	56	215
ME64P2-PNP	3 yds	4980	5378	5976	84	15 3/4	56	215
ME64R2-PNP	3 yds	5207	5623	6248	90	15 3/4	56	225
ME64S2-PNP	3 1/4 yds	5423	5857	6508	96	15 3/4	56	225
ME64T2-PNP	3 1/2 yds	5650	6102	6779	102	15 3/4	56	235
ME64U2-PNP	3 3/4 yds	5876	6346	7051	108	15 3/4	56	235
ME64V2-PNP	4 1/4 yds	6113	6602	7336	114	15 3/4	56	245
ME64W2-PNP	4 1/4 yds	6350	6858	7620	120	15 3/4	56	245

**Veneer species must be noted on each line item**

Wall mount, flush top without profile edge detail, fabric tack panel (fabric not included, COM must be acrylic backed). Open center storage, one adjustable shelf. Cabinet back unfinished. Optional task lights available, see HBF Casegood Accessories.

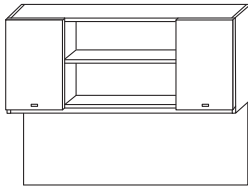

ME65M2-PNP		4414	4767	5296	72	15 3/4	56	195
------------	--	------	------	------	----	--------	----	-----

**Veneer species must be noted on each line item**

Wall mount, flush top without profile edge detail, finished wood panel. Open center storage, one adjustable shelf. Cabinet back unfinished. Optional task lights available, see HBF Casegood Accessories.

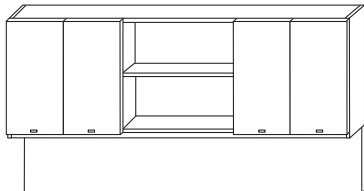

ME65N2-PNP		5062	5467	6075	78	15 3/4	56	215
ME65P2-PNP		5320	5746	6384	84	15 3/4	56	215
ME65R2-PNP		5536	5979	6644	90	15 3/4	56	225
ME65S2-PNP		5783	6246	6940	96	15 3/4	56	225
ME65T2-PNP		6031	6513	7237	102	15 3/4	56	235
ME65U2-PNP		6257	6758	7509	108	15 3/4	56	235
ME65V2-PNP		6494	7014	7793	114	15 3/4	56	245
ME65W2-PNP		6731	7270	8077	120	15 3/4	56	245

**Veneer species must be noted on each line item**

Wall mount, flush top without profile edge detail, finished wood panel. Open center storage, one adjustable shelf. Cabinet back unfinished. Optional task lights available, see HBF Casegood Accessories.

**Double high overhead cabinets to be used with double high vertical cabinets.  
Installation and maintenance of wall mounted overhead cabinets are the sole responsibility of the customer.  
Proper installation is crucial to prevent personal injury.**

**Veneer species must be noted on each line item**

Veneer Grade 1	Veneer Grade 2	Veneer Grade 3
Cherry	Rift Oak	Anigre
Maple	Sapele	
Ligno-Grain		
Walnut		

# HBF Mercer Casegoods - Overhead Cabinets

Style Number	Fabric	List Price			Dimensions			Weight
		Veneer 1	Veneer 2	Veneer 3	OW	OD	OH	

## Overhead Cabinets, Top without Profile Edge Detail (Double High)

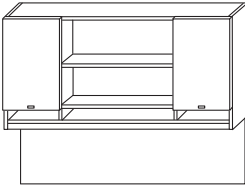

<b>ME64M2-PWP</b>	3 yds	<b>4589</b>	<b>4956</b>	<b>5506</b>	72	15 3/4	56	195
-------------------	-------	-------------	-------------	-------------	----	--------	----	-----

**Veneer species must be noted on each line item**

Wall mount, flush top without profile edge detail, fabric tack panel (fabric not included, COM must be acrylic backed). Open center storage, one adjustable shelf, open project shelf storage 3" high. Cabinet back unfinished. Optional task lights available, see HBF Casegood Accessories.

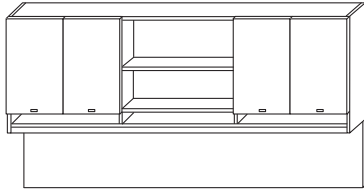

<b>ME64N2-PWP</b>	3 yds	<b>5279</b>	<b>5701</b>	<b>6335</b>	78	15 3/4	56	215
<b>ME64P2-PWP</b>	3 yds	<b>5526</b>	<b>5968</b>	<b>6631</b>	84	15 3/4	56	215
<b>ME64R2-PWP</b>	3 yds	<b>5773</b>	<b>6235</b>	<b>6928</b>	90	15 3/4	56	225
<b>ME64S2-PWP</b>	3 1/4 yds	<b>6010</b>	<b>6491</b>	<b>7212</b>	96	15 3/4	56	225
<b>ME64T2-PWP</b>	3 1/2 yds	<b>6268</b>	<b>6769</b>	<b>7521</b>	102	15 3/4	56	235
<b>ME64U2-PWP</b>	3 3/4 yds	<b>6515</b>	<b>7036</b>	<b>7818</b>	108	15 3/4	56	235
<b>ME64V2-PWP</b>	4 1/4 yds	<b>6752</b>	<b>7292</b>	<b>8102</b>	114	15 3/4	56	245
<b>ME64W2-PWP</b>	4 1/4 yds	<b>6989</b>	<b>7548</b>	<b>8386</b>	120	15 3/4	56	245

**Veneer species must be noted on each line item**

Wall mount, flush top without profile edge detail, fabric tack panel (fabric not included, COM must be acrylic backed). Open center storage, one adjustable shelf, open project shelf storage 3" high. Cabinet back unfinished. Optional task lights available, see HBF Casegood Accessories.

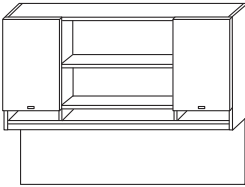

<b>ME65M2-PWP</b>		<b>4898</b>	<b>5289</b>	<b>5877</b>	72	15 3/4	56	195
-------------------	--	-------------	-------------	-------------	----	--------	----	-----

**Veneer species must be noted on each line item**

Wall mount, flush top without profile edge detail, finished wood panel. Open center storage, one adjustable shelf, open project shelf storage 3" high. Cabinet back unfinished. Optional task lights available, see HBF Casegood Accessories.

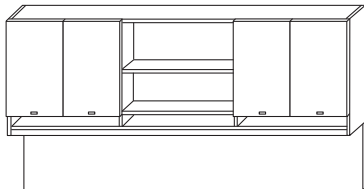

<b>ME65N2-PWP</b>		<b>5619</b>	<b>6068</b>	<b>6742</b>	78	15 3/4	56	215
<b>ME65P2-PWP</b>		<b>5897</b>	<b>6368</b>	<b>7076</b>	84	15 3/4	56	215
<b>ME65R2-PWP</b>		<b>6144</b>	<b>6635</b>	<b>7373</b>	90	15 3/4	56	225
<b>ME65S2-PWP</b>		<b>6412</b>	<b>6925</b>	<b>7694</b>	96	15 3/4	56	225
<b>ME65T2-PWP</b>		<b>6690</b>	<b>7225</b>	<b>8028</b>	102	15 3/4	56	235
<b>ME65U2-PWP</b>		<b>6937</b>	<b>7492</b>	<b>8324</b>	108	15 3/4	56	235
<b>ME65V2-PWP</b>		<b>7174</b>	<b>7748</b>	<b>8609</b>	114	15 3/4	56	245
<b>ME65W2-PWP</b>		<b>7411</b>	<b>8004</b>	<b>8893</b>	120	15 3/4	56	245

**Veneer species must be noted on each line item**

Wall mount, flush top without profile edge detail, finished wood panel. Open center storage, one adjustable shelf, open project shelf storage 3" high. Cabinet back unfinished. Optional task lights available, see HBF Casegood Accessories.

**Double high overhead cabinets to be used with double high vertical cabinets.  
Installation and maintenance of wall mounted overhead cabinets are the sole responsibility of the customer.  
Proper installation is crucial to prevent personal injury.**

**Veneer species must be noted on each line item**

<u>Veneer Grade 1</u>	<u>Veneer Grade 2</u>	<u>Veneer Grade 3</u>
Cherry	Rift Oak	Anigre
Maple	Sapele	
Ligno-Grain		
Walnut		

# HBF Mercer Casegoods - Overhead Cabinets

Style Number	Fabric	List Price			Dimensions			Weight
		Veneer 1	Veneer 2	Veneer 3	OW	OD	OH	

## Overhead Cabinets, Top with Profile Edge Detail

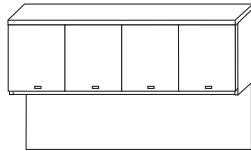

ME64A-FNP	3 yds	3445	3721	4134	72	15 3/4	43 5/8	205
-----------	-------	------	------	------	----	--------	--------	-----

**Veneer species must be noted on each line item**

Wall mount, top with profile edge detail, fabric tack panel (fabric not included, COM must be acrylic backed), cabinet back unfinished. Optional task lights available, see HBF Casegood Accessories.

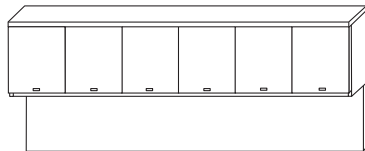

ME64F-FNP	3 yds	3960	4277	4752	78	15 3/4	43 5/8	225
ME64B-FNP	3 yds	4156	4489	4987	84	15 3/4	43 5/8	225
ME64C-FNP	3 yds	4341	4689	5210	90	15 3/4	43 5/8	235
ME64D-FNP	3 1/4 yds	4527	4889	5432	96	15 3/4	43 5/8	235
ME64G-FNP	3 1/2 yds	4723	5100	5667	102	15 3/4	43 5/8	245
ME64E-FNP	3 3/4 yds	4908	5301	5890	108	15 3/4	43 5/8	245
ME64H-FNP	4 1/4 yds	5093	5501	6112	114	15 3/4	43 5/8	255
ME64J-FNP	4 1/4 yds	5279	5701	6335	120	15 3/4	43 5/8	255

**Veneer species must be noted on each line item**

Wall mount, top with profile edge detail, fabric tack panel (fabric not included, COM must be acrylic backed), cabinet back unfinished. Optional task lights available, see HBF Casegood Accessories.

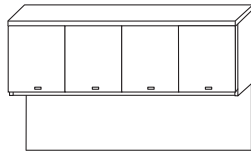

ME65A-FNP		3682	3977	4419	72	15 3/4	43 5/8	205
-----------	--	------	------	------	----	--------	--------	-----

**Veneer species must be noted on each line item**

Wall mount, top with profile edge detail, finished wood panel, cabinet back unfinished. Optional task lights available, see HBF Casegood Accessories.

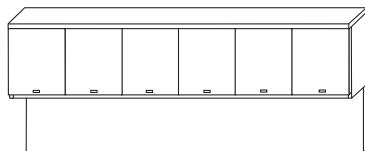

ME65F-FNP		4228	4566	5074	78	15 3/4	43 5/8	225
ME65B-FNP		4444	4800	5333	84	15 3/4	43 5/8	225
ME65C-FNP		4630	5000	5556	90	15 3/4	43 5/8	235
ME65D-FNP		4826	5212	5791	96	15 3/4	43 5/8	235
ME65G-FNP		5042	5445	6050	102	15 3/4	43 5/8	245
ME65E-FNP		5227	5645	6273	108	15 3/4	43 5/8	245
ME65H-FNP		5413	5846	6495	114	15 3/4	43 5/8	255
ME65J-FNP		5598	6046	6718	120	15 3/4	43 5/8	255

**Veneer species must be noted on each line item**

Wall mount, top with profile edge detail, finished wood panel, cabinet back unfinished. Optional task lights available, see HBF Casegood Accessories.

**Installation and maintenance of wall mounted overhead cabinets are the sole responsibility of the customer.  
Proper installation is crucial to prevent personal injury.**

**Veneer species must be noted on each line item**

<u>Veneer Grade 1</u>	<u>Veneer Grade 2</u>	<u>Veneer Grade 3</u>
Cherry	Rift Oak	Anigre
Maple	Sapele	
Ligno-Grain		
Walnut		

# HBF Mercer Casegoods - Overhead Cabinets

Style Number	Fabric	List Price			Dimensions			Weight
		Veneer 1	Veneer 2	Veneer 3	OW	OD	OH	

## Overhead Cabinets, Top with Profile Edge Detail

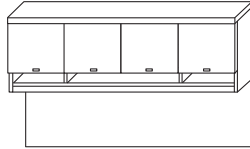

<b>ME64A-FWP</b>	3 yds	<b>3806</b>	<b>4110</b>	<b>4567</b>	72	15 3/4	43 5/8	205
------------------	-------	-------------	-------------	-------------	----	--------	--------	-----

**Veneer species must be noted on each line item**

Wall mount, top with profile edge detail, fabric tack panel (fabric not included, COM must be acrylic backed). Open project shelf storage 3" high. Cabinet back unfinished. Optional task lights available, see HBF Casegood Accessories.

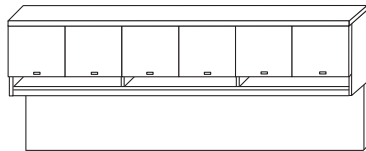

<b>ME64F-FWP</b>	3 yds	<b>4383</b>	<b>4733</b>	<b>5259</b>	78	15 3/4	43 5/8	225
<b>ME64B-FWP</b>	3 yds	<b>4599</b>	<b>4967</b>	<b>5519</b>	84	15 3/4	43 5/8	225
<b>ME64C-FWP</b>	3 yds	<b>4795</b>	<b>5178</b>	<b>5754</b>	90	15 3/4	43 5/8	235
<b>ME64D-FWP</b>	3 1/4 yds	<b>5001</b>	<b>5401</b>	<b>6001</b>	96	15 3/4	43 5/8	235
<b>ME64G-FWP</b>	3 1/2 yds	<b>5217</b>	<b>5634</b>	<b>6260</b>	102	15 3/4	43 5/8	245
<b>ME64E-FWP</b>	3 3/4 yds	<b>5413</b>	<b>5846</b>	<b>6495</b>	108	15 3/4	43 5/8	245
<b>ME64H-FWP</b>	4 1/4 yds	<b>5598</b>	<b>6046</b>	<b>6718</b>	114	15 3/4	43 5/8	255
<b>ME64J-FWP</b>	4 1/4 yds	<b>5783</b>	<b>6246</b>	<b>6940</b>	120	15 3/4	43 5/8	255

**Veneer species must be noted on each line item**

Wall mount, top with profile edge detail, fabric tack panel (fabric not included, COM must be acrylic backed). Open project shelf storage 3" high. Cabinet back unfinished. Optional task lights available, see HBF Casegood Accessories.

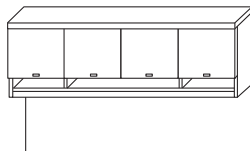

<b>ME65A-FWP</b>		<b>4074</b>	<b>4400</b>	<b>4888</b>	72	15 3/4	43 5/8	205
------------------	--	-------------	-------------	-------------	----	--------	--------	-----

**Veneer species must be noted on each line item**

Wall mount, top with profile edge detail, finished wood panel. Open project shelf storage 3" high. Cabinet back unfinished. Optional task lights available, see HBF Casegood Accessories.

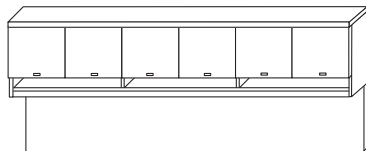

<b>ME65F-FWP</b>		<b>4671</b>	<b>5045</b>	<b>5605</b>	78	15 3/4	43 5/8	225
<b>ME65B-FWP</b>		<b>4630</b>	<b>5000</b>	<b>5556</b>	84	15 3/4	43 5/8	225
<b>ME65C-FWP</b>		<b>5114</b>	<b>5523</b>	<b>6137</b>	90	15 3/4	43 5/8	235
<b>ME65D-FWP</b>		<b>5330</b>	<b>5757</b>	<b>6396</b>	96	15 3/4	43 5/8	235
<b>ME65G-FWP</b>		<b>5567</b>	<b>6013</b>	<b>6681</b>	102	15 3/4	43 5/8	245
<b>ME65E-FWP</b>		<b>5773</b>	<b>6235</b>	<b>6928</b>	108	15 3/4	43 5/8	245
<b>ME65H-FWP</b>		<b>5959</b>	<b>6435</b>	<b>7150</b>	114	15 3/4	43 5/8	255
<b>ME65J-FWP</b>		<b>6144</b>	<b>6635</b>	<b>7373</b>	120	15 3/4	43 5/8	255

**Veneer species must be noted on each line item**

Wall mount, top with profile edge detail, finished wood panel. Open project shelf storage 3" high. Cabinet back unfinished. Optional task lights available, see HBF Casegood Accessories.

**Installation and maintenance of wall mounted overhead cabinets are the sole responsibility of the customer.**

**Proper installation is crucial to prevent personal injury.**

**Veneer species must be noted on each line item**

<u>Veneer Grade 1</u>	<u>Veneer Grade 2</u>	<u>Veneer Grade 3</u>
Cherry	Rift Oak	Anigre
Maple	Sapele	
Ligno-Grain		
Walnut		

# HBF Mercer Casegoods - Overhead Cabinets

Style Number	Fabric	List Price			Dimensions			Weight
		Veneer 1	Veneer 2	Veneer 3	OW	OD	OH	

## Overhead Cabinets, Top with Profile Edge Detail

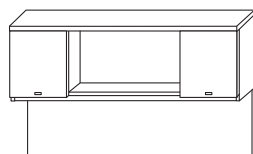

<b>ME64A-PNP</b>	3 yds	<b>3260</b>	<b>3521</b>	<b>3912</b>	72	15 3/4	43 5/8	200
------------------	-------	-------------	-------------	-------------	----	--------	--------	-----

**Veneer species must be noted on each line item**

Wall mount, top with profile edge detail, fabric tack panel (fabric not included, COM must be acrylic backed). Open center storage. Cabinet back unfinished. Optional task lights available, see HBF Casegood Accessories.

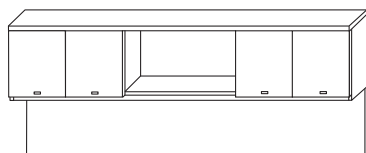

<b>ME64F-PNP</b>	3 yds	<b>3754</b>	<b>4055</b>	<b>4505</b>	78	15 3/4	43 5/8	215
<b>ME64B-PNP</b>	3 yds	<b>3940</b>	<b>4255</b>	<b>4728</b>	84	15 3/4	43 5/8	215
<b>ME64C-PNP</b>	3 yds	<b>4115</b>	<b>4444</b>	<b>4938</b>	90	15 3/4	43 5/8	225
<b>ME64D-PNP</b>	3 1/4 yds	<b>4290</b>	<b>4633</b>	<b>5148</b>	96	15 3/4	43 5/8	225
<b>ME64G-PNP</b>	3 1/2 yds	<b>4475</b>	<b>4833</b>	<b>5370</b>	102	15 3/4	43 5/8	235
<b>ME64E-PNP</b>	3 3/4 yds	<b>4650</b>	<b>5022</b>	<b>5581</b>	108	15 3/4	43 5/8	235
<b>ME64H-PNP</b>	4 1/4 yds	<b>4836</b>	<b>5223</b>	<b>5803</b>	114	15 3/4	43 5/8	245
<b>ME64J-PNP</b>	4 1/4 yds	<b>5021</b>	<b>5423</b>	<b>6026</b>	120	15 3/4	43 5/8	245

**Veneer species must be noted on each line item**

Wall mount, top with profile edge detail, fabric tack panel (fabric not included, COM must be acrylic backed). Open center storage. Cabinet back unfinished. Optional task lights available, see HBF Casegood Accessories.

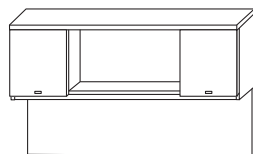

<b>ME65A-PNP</b>		<b>3487</b>	<b>3765</b>	<b>4184</b>	72	15 3/4	43 5/8	200
------------------	--	-------------	-------------	-------------	----	--------	--------	-----

**Veneer species must be noted on each line item**

Wall mount, top with profile edge detail, finished wood panel. Open center storage. Cabinet back unfinished. Optional task lights available, see HBF Casegood Accessories.

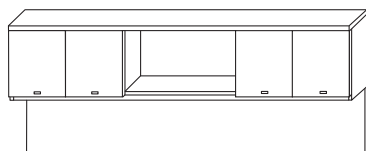

<b>ME65F-PNP</b>		<b>4002</b>	<b>4322</b>	<b>4802</b>	78	15 3/4	43 5/8	215
<b>ME65B-PNP</b>		<b>4208</b>	<b>4544</b>	<b>5049</b>	84	15 3/4	43 5/8	215
<b>ME65C-PNP</b>		<b>4383</b>	<b>4733</b>	<b>5259</b>	90	15 3/4	43 5/8	225
<b>ME65D-PNP</b>		<b>4578</b>	<b>4945</b>	<b>5494</b>	96	15 3/4	43 5/8	225
<b>ME65G-PNP</b>		<b>4784</b>	<b>5167</b>	<b>5741</b>	102	15 3/4	43 5/8	235
<b>ME65E-PNP</b>		<b>4959</b>	<b>5356</b>	<b>5951</b>	108	15 3/4	43 5/8	235
<b>ME65H-PNP</b>		<b>5145</b>	<b>5556</b>	<b>6174</b>	114	15 3/4	43 5/8	245
<b>ME65J-PNP</b>		<b>5330</b>	<b>5757</b>	<b>6396</b>	120	15 3/4	43 5/8	245

**Veneer species must be noted on each line item**

Wall mount, top with profile edge detail, finished wood panel. Open center storage. Cabinet back unfinished. Optional task lights available, see HBF Casegood Accessories.

**Installation and maintenance of wall mounted overhead cabinets are the sole responsibility of the customer.  
Proper installation is crucial to prevent personal injury.**

**Veneer species must be noted on each line item**

<u>Veneer Grade 1</u>	<u>Veneer Grade 2</u>	<u>Veneer Grade 3</u>
Cherry	Rift Oak	Anigre
Maple	Sapele	
Ligno-Grain		
Walnut		

# HBF Mercer Casegoods - Overhead Cabinets

Style Number	Fabric	List Price			Dimensions			Weight
		Veneer 1	Veneer 2	Veneer 3	OW	OD	OH	

## Overhead Cabinets, Top with Profile Edge Detail

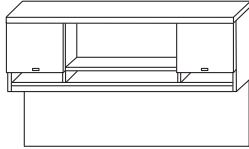

<b>ME64A-PWP</b>	3 yds	<b>3620</b>	<b>3910</b>	<b>4345</b>	72	15 3/4	43 5/8	200
------------------	-------	-------------	-------------	-------------	----	--------	--------	-----

**Veneer species must be noted on each line item**

Wall mount, top with profile edge detail, fabric tack panel (fabric not included, COM must be acrylic backed). Open project shelf storage 3" high and open center storage. Cabinet back unfinished. Optional task lights available, see HBF Casegood Accessories.

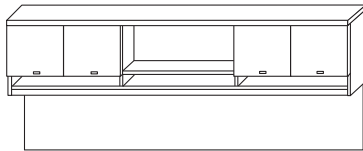

<b>ME64F-PWP</b>	3 yds	<b>4177</b>	<b>4511</b>	<b>5012</b>	78	15 3/4	43 5/8	215
<b>ME64B-PWP</b>	3 yds	<b>4383</b>	<b>4733</b>	<b>5259</b>	84	15 3/4	43 5/8	215
<b>ME64C-PWP</b>	3 yds	<b>4568</b>	<b>4933</b>	<b>5482</b>	90	15 3/4	43 5/8	225
<b>ME64D-PWP</b>	3 1/4 yds	<b>4764</b>	<b>5145</b>	<b>5717</b>	96	15 3/4	43 5/8	225
<b>ME64G-PWP</b>	3 1/2 yds	<b>4970</b>	<b>5367</b>	<b>5964</b>	102	15 3/4	43 5/8	235
<b>ME64E-PWP</b>	3 3/4 yds	<b>5165</b>	<b>5579</b>	<b>6199</b>	108	15 3/4	43 5/8	235
<b>ME64H-PWP</b>	4 1/4 yds	<b>5351</b>	<b>5779</b>	<b>6421</b>	114	15 3/4	43 5/8	245
<b>ME64J-PWP</b>	4 1/4 yds	<b>5536</b>	<b>5979</b>	<b>6644</b>	120	15 3/4	43 5/8	245

**Veneer species must be noted on each line item**

Wall mount, top with profile edge detail, fabric tack panel (fabric not included, COM must be acrylic backed). Open project shelf storage 3" high and open center storage. Cabinet back unfinished. Optional task lights available, see HBF Casegood Accessories.

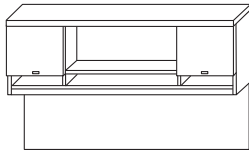

<b>ME65A-PWP</b>		<b>3878</b>	<b>4188</b>	<b>4654</b>	72	15 3/4	43 5/8	200
------------------	--	-------------	-------------	-------------	----	--------	--------	-----

**Veneer species must be noted on each line item**

Wall mount, top with profile edge detail, finished wood panel). Open project shelf storage 3" high and open center storage. Cabinet back unfinished. Optional task lights available, see HBF Casegood Accessories.

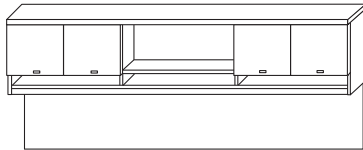

<b>ME65F-PWP</b>		<b>4444</b>	<b>4800</b>	<b>5333</b>	78	15 3/4	43 5/8	215
<b>ME65B-PWP</b>		<b>4671</b>	<b>5045</b>	<b>5605</b>	84	15 3/4	43 5/8	215
<b>ME65C-PWP</b>		<b>4867</b>	<b>5256</b>	<b>5840</b>	90	15 3/4	43 5/8	225
<b>ME65D-PWP</b>		<b>5083</b>	<b>5490</b>	<b>6100</b>	96	15 3/4	43 5/8	225
<b>ME65G-PWP</b>		<b>5310</b>	<b>5734</b>	<b>6372</b>	102	15 3/4	43 5/8	235
<b>ME65E-PWP</b>		<b>5505</b>	<b>5946</b>	<b>6606</b>	108	15 3/4	43 5/8	235
<b>ME65H-PWP</b>		<b>5691</b>	<b>6146</b>	<b>6829</b>	114	15 3/4	43 5/8	245
<b>ME65J-PWP</b>		<b>5876</b>	<b>6346</b>	<b>7051</b>	120	15 3/4	43 5/8	245

**Veneer species must be noted on each line item**

Wall mount, top with profile edge detail, finished wood panel). Open project shelf storage 3" high and open center storage. Cabinet back unfinished. Optional task lights available, see HBF Casegood Accessories.

**Installation and maintenance of wall mounted overhead cabinets are the sole responsibility of the customer.  
Proper installation is crucial to prevent personal injury.**

**Veneer species must be noted on each line item**

<u>Veneer Grade 1</u>	<u>Veneer Grade 2</u>	<u>Veneer Grade 3</u>
Cherry	Rift Oak	Anigre
Maple	Sapele	
Ligno-Grain		
Walnut		



# HBF Mercer Casegoods - Overhead Cabinets

Style Number	Fabric	List Price			Dimensions			Weight
		Veneer 1	Veneer 2	Veneer 3	OW	OD	OH	

## Overhead Cabinets, Top with Profile Edge Detail (Double High)

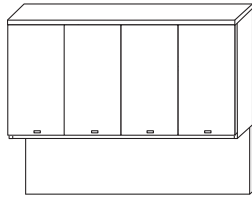

<b>ME64A2-FNP</b>	3 yds	<b>4723</b>	<b>5100</b>	<b>5667</b>	72	15 3/4	57 3/8	210
-------------------	-------	-------------	-------------	-------------	----	--------	--------	-----

**Veneer species must be noted on each line item**

Wall mount, top with profile edge detail, one adjustable shelf, fabric tack panel (fabric not included, COM must be acrylic backed), cabinet back unfinished. Optional task lights available, see HBF Casegood Accessories.

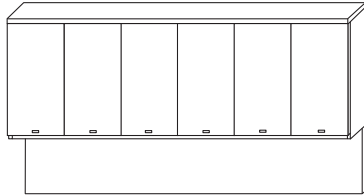

<b>ME64F2-FNP</b>	3 yds	<b>5433</b>	<b>5868</b>	<b>6520</b>	78	15 3/4	57 3/8	230
<b>ME64B2-FNP</b>	3 yds	<b>5691</b>	<b>6146</b>	<b>6829</b>	84	15 3/4	57 3/8	230
<b>ME64C2-FNP</b>	3 yds	<b>5938</b>	<b>6413</b>	<b>7126</b>	90	15 3/4	57 3/8	240
<b>ME64D2-FNP</b>	3 1/4 yds	<b>6195</b>	<b>6691</b>	<b>7435</b>	96	15 3/4	57 3/8	240
<b>ME64G2-FNP</b>	3 1/2 yds	<b>6453</b>	<b>6969</b>	<b>7744</b>	102	15 3/4	57 3/8	250
<b>ME64E2-FNP</b>	3 3/4 yds	<b>6700</b>	<b>7236</b>	<b>8040</b>	108	15 3/4	57 3/8	250
<b>ME64H2-FNP</b>	4 1/4 yds	<b>6937</b>	<b>7492</b>	<b>8324</b>	114	15 3/4	57 3/8	260
<b>ME64J2-FNP</b>	4 1/4 yds	<b>7174</b>	<b>7748</b>	<b>8609</b>	120	15 3/4	57 3/8	260

**Veneer species must be noted on each line item**

Wall mount, top with profile edge detail, one adjustable shelf, fabric tack panel (fabric not included, COM must be acrylic backed), cabinet back unfinished. Optional task lights available, see HBF Casegood Accessories.

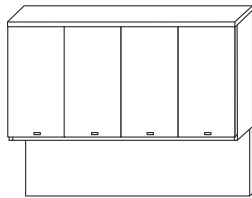

<b>ME65A2-FNP</b>		<b>5052</b>	<b>5456</b>	<b>6063</b>	72	15 3/4	57 3/8	210
-------------------	--	-------------	-------------	-------------	----	--------	--------	-----

**Veneer species must be noted on each line item**

Wall mount, top with profile edge detail, one adjustable shelf, finished wood panel, cabinet back unfinished. Optional task lights available, see HBF Casegood Accessories.

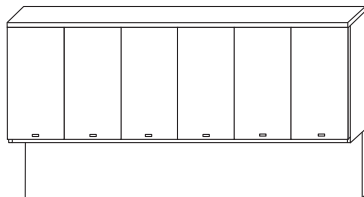

<b>ME65F2-FNP</b>		<b>5783</b>	<b>6246</b>	<b>6940</b>	78	15 3/4	57 3/8	230
<b>ME65B2-FNP</b>		<b>6072</b>	<b>6558</b>	<b>7286</b>	84	15 3/4	57 3/8	230
<b>ME65C2-FNP</b>		<b>6329</b>	<b>6836</b>	<b>7595</b>	90	15 3/4	57 3/8	240
<b>ME65D2-FNP</b>		<b>6597</b>	<b>7125</b>	<b>7917</b>	96	15 3/4	57 3/8	240
<b>ME65G2-FNP</b>		<b>6886</b>	<b>7436</b>	<b>8263</b>	102	15 3/4	57 3/8	250
<b>ME65E2-FNP</b>		<b>7143</b>	<b>7714</b>	<b>8572</b>	108	15 3/4	57 3/8	250
<b>ME65H2-FNP</b>		<b>7380</b>	<b>7970</b>	<b>8856</b>	114	15 3/4	57 3/8	260
<b>ME65J2-FNP</b>		<b>7617</b>	<b>8226</b>	<b>9140</b>	120	15 3/4	57 3/8	260

**Veneer species must be noted on each line item**

Wall mount, top with profile edge detail, one adjustable shelf, finished wood panel, cabinet back unfinished. Optional task lights available, see HBF Casegood Accessories.

**Double high overhead cabinets to be used with double high vertical cabinets.  
Installation and maintenance of wall mounted overhead cabinets are the sole responsibility of the customer.  
Proper installation is crucial to prevent personal injury.**

**Veneer species must be noted on each line item**

<u>Veneer Grade 1</u>	<u>Veneer Grade 2</u>	<u>Veneer Grade 3</u>
Cherry	Rift Oak	Anigre
Maple	Sapele	
Ligno-Grain		
Walnut		

# HBF Mercer Casegoods - Overhead Cabinets

Style Number	Fabric	List Price			Dimensions			Weight
		Veneer 1	Veneer 2	Veneer 3	OW	OD	OH	

## Overhead Cabinets, Top with Profile Edge Detail (Double High)

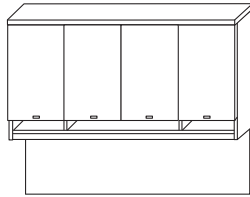

<b>ME64A2-FWP</b>	3 yds	<b>5217</b>	<b>5634</b>	<b>6260</b>	72	15 3/4	57 3/8	210
-------------------	-------	-------------	-------------	-------------	----	--------	--------	-----

**Veneer species must be noted on each line item**

Wall mount, top with profile edge detail, one adjustable shelf, fabric tack panel (fabric not included, COM must be acrylic backed). Open project shelf storage 3" high. Cabinet back unfinished. Optional task lights available, see HBF Casegood Accessories.

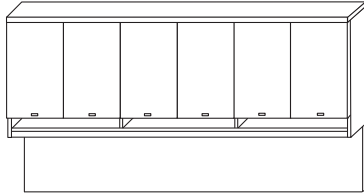

<b>ME64F2-FWP</b>	3 yds	<b>5989</b>	<b>6469</b>	<b>7187</b>	78	15 3/4	57 3/8	230
<b>ME64B2-FWP</b>	3 yds	<b>6288</b>	<b>6791</b>	<b>7546</b>	84	15 3/4	57 3/8	230
<b>ME64C2-FWP</b>	3 yds	<b>6556</b>	<b>7080</b>	<b>7867</b>	90	15 3/4	57 3/8	240
<b>ME64D2-FWP</b>	3 1/4 yds	<b>6834</b>	<b>7381</b>	<b>8201</b>	96	15 3/4	57 3/8	240
<b>ME64G2-FWP</b>	3 1/2 yds	<b>7122</b>	<b>7692</b>	<b>8547</b>	102	15 3/4	57 3/8	250
<b>ME64E2-FWP</b>	3 3/4 yds	<b>7390</b>	<b>7981</b>	<b>8868</b>	108	15 3/4	57 3/8	250
<b>ME64H2-FWP</b>	4 1/4 yds	<b>7627</b>	<b>8237</b>	<b>9153</b>	114	15 3/4	57 3/8	260
<b>ME64J2-FWP</b>	4 1/4 yds	<b>7864</b>	<b>8493</b>	<b>9437</b>	120	15 3/4	57 3/8	260

**Veneer species must be noted on each line item**

Wall mount, top with profile edge detail, one adjustable shelf, fabric tack panel (fabric not included, COM must be acrylic backed). Open project shelf storage 3" high. Cabinet back unfinished. Optional task lights available, see HBF Casegood Accessories.

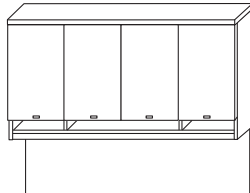

<b>ME65A2-FWP</b>		<b>5577</b>	<b>6024</b>	<b>6693</b>	72	15 3/4	57 3/8	210
-------------------	--	-------------	-------------	-------------	----	--------	--------	-----

**Veneer species must be noted on each line item**

Wall mount, top with profile edge detail, one adjustable shelf, finished wood panel. Open project shelf storage 3" high. Cabinet back unfinished. Optional task lights available, see HBF Casegood Accessories.

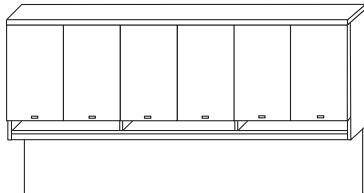

<b>ME65F2-FWP</b>		<b>6381</b>	<b>6891</b>	<b>7657</b>	78	15 3/4	57 3/8	230
<b>ME65B2-FWP</b>		<b>6700</b>	<b>7236</b>	<b>8040</b>	84	15 3/4	57 3/8	230
<b>ME65C2-FWP</b>		<b>6978</b>	<b>7537</b>	<b>8374</b>	90	15 3/4	57 3/8	240
<b>ME65D2-FWP</b>		<b>7277</b>	<b>7859</b>	<b>8732</b>	96	15 3/4	57 3/8	240
<b>ME65G2-FWP</b>		<b>7596</b>	<b>8204</b>	<b>9116</b>	102	15 3/4	57 3/8	250
<b>ME65E2-FWP</b>		<b>7874</b>	<b>8504</b>	<b>9449</b>	108	15 3/4	57 3/8	250
<b>ME65H2-FWP</b>		<b>8111</b>	<b>8760</b>	<b>9734</b>	114	15 3/4	57 3/8	260
<b>ME65J2-FWP</b>		<b>8348</b>	<b>9016</b>	<b>10018</b>	120	15 3/4	57 3/8	260

**Veneer species must be noted on each line item**

Wall mount, top with profile edge detail, one adjustable shelf, finished wood panel. Open project shelf storage 3" high. Cabinet back unfinished. Optional task lights available, see HBF Casegood Accessories.

**Double high overhead cabinets to be used with double high vertical cabinets.  
Installation and maintenance of wall mounted overhead cabinets are the sole responsibility of the customer.  
Proper installation is crucial to prevent personal injury.**

**Veneer species must be noted on each line item**

<u>Veneer Grade 1</u>	<u>Veneer Grade 2</u>	<u>Veneer Grade 3</u>
Cherry	Rift Oak	Anigre
Maple	Sapele	
Ligno-Grain		
Walnut		

# HBF Mercer Casegoods - Overhead Cabinets

Style Number	Fabric	List Price			Dimensions			Weight
		Veneer 1	Veneer 2	Veneer 3	OW	OD	OH	

## Overhead Cabinets, Top with Profile Edge Detail (Double High)

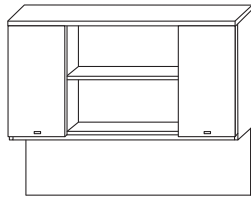

<b>ME64A2-PNP</b>	3 yds	<b>4475</b>	<b>4833</b>	<b>5370</b>	72	15 3/4	57 3/8	200
-------------------	-------	-------------	-------------	-------------	----	--------	--------	-----

**Veneer species must be noted on each line item**

Wall mount, top with profile edge detail, fabric tack panel (fabric not included, COM must be acrylic backed). Open center storage, one adjustable shelf. Cabinet back unfinished. Optional task lights available, see HBF Casegood Accessories.

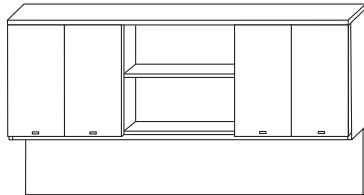

<b>ME64F2-PNP</b>	3 yds	<b>5155</b>	<b>5568</b>	<b>6186</b>	78	15 3/4	57 3/8	220
<b>ME64B2-PNP</b>	3 yds	<b>5402</b>	<b>5835</b>	<b>6483</b>	84	15 3/4	57 3/8	220
<b>ME64C2-PNP</b>	3 yds	<b>5639</b>	<b>6090</b>	<b>6767</b>	90	15 3/4	57 3/8	230
<b>ME64D2-PNP</b>	3 1/4 yds	<b>5876</b>	<b>6346</b>	<b>7051</b>	96	15 3/4	57 3/8	230
<b>ME64G2-PNP</b>	3 1/2 yds	<b>6123</b>	<b>6613</b>	<b>7348</b>	102	15 3/4	57 3/8	240
<b>ME64E2-PNP</b>	3 3/4 yds	<b>6360</b>	<b>6869</b>	<b>7632</b>	108	15 3/4	57 3/8	240
<b>ME64H2-PNP</b>	4 1/4 yds	<b>6597</b>	<b>7125</b>	<b>7917</b>	114	15 3/4	57 3/8	250
<b>ME64J2-PNP</b>	4 1/4 yds	<b>6834</b>	<b>7381</b>	<b>8201</b>	120	15 3/4	57 3/8	250

**Veneer species must be noted on each line item**

Wall mount, top with profile edge detail, fabric tack panel (fabric not included, COM must be acrylic backed). Open center storage, one adjustable shelf. Cabinet back unfinished. Optional task lights available, see HBF Casegood Accessories.

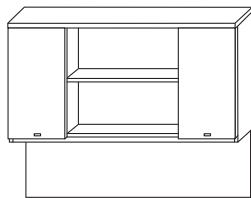

<b>ME65A2-PNP</b>		<b>4784</b>	<b>5167</b>	<b>5741</b>	72	15 3/4	57 3/8	200
-------------------	--	-------------	-------------	-------------	----	--------	--------	-----

**Veneer species must be noted on each line item**

Wall mount, top with profile edge detail, finished wood panel. Open center storage, one adjustable shelf. Cabinet back unfinished. Optional task lights available, see HBF Casegood Accessories.

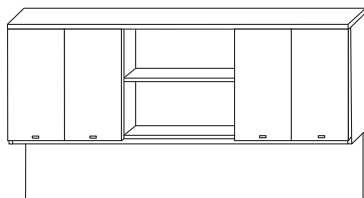

<b>ME65F2-PNP</b>		<b>5485</b>	<b>5924</b>	<b>6582</b>	78	15 3/4	57 3/8	220
<b>ME65B2-PNP</b>		<b>5753</b>	<b>6213</b>	<b>6903</b>	84	15 3/4	57 3/8	220
<b>ME65C2-PNP</b>		<b>6000</b>	<b>6480</b>	<b>7200</b>	90	15 3/4	57 3/8	230
<b>ME65D2-PNP</b>		<b>6257</b>	<b>6758</b>	<b>7509</b>	96	15 3/4	57 3/8	230
<b>ME65G2-PNP</b>		<b>6535</b>	<b>7058</b>	<b>7842</b>	102	15 3/4	57 3/8	240
<b>ME65E2-PNP</b>		<b>6772</b>	<b>7314</b>	<b>8127</b>	108	15 3/4	57 3/8	240
<b>ME65H2-PNP</b>		<b>7009</b>	<b>7570</b>	<b>8411</b>	114	15 3/4	57 3/8	250
<b>ME65J2-PNP</b>		<b>7246</b>	<b>7826</b>	<b>8695</b>	120	15 3/4	57 3/8	250

**Veneer species must be noted on each line item**

Wall mount, top with profile edge detail, finished wood panel. Open center storage, one adjustable shelf. Cabinet back unfinished. Optional task lights available, see HBF Casegood Accessories.

**Double high overhead cabinets to be used with double high vertical cabinets.  
Installation and maintenance of wall mounted overhead cabinets are the sole responsibility of the customer.  
Proper installation is crucial to prevent personal injury.**

**Veneer species must be noted on each line item**

<u>Veneer Grade 1</u>	<u>Veneer Grade 2</u>	<u>Veneer Grade 3</u>
Cherry	Rift Oak	Anigre
Maple	Sapele	
Ligno-Grain		
Walnut		

# HBF Mercer Casegoods - Overhead Cabinets

Style Number	Fabric	List Price			Dimensions			Weight
		Veneer 1	Veneer 2	Veneer 3	OW	OD	OH	

## Overhead Cabinets, Top with Profile Edge Detail, (Double High)

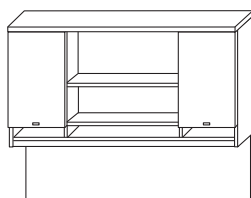

<b>ME64A2-PWP</b>	3 yds	<b>4970</b>	<b>5367</b>	<b>5964</b>	72	15 3/4	57 3/8	200
-------------------	-------	-------------	-------------	-------------	----	--------	--------	-----

**Veneer species must be noted on each line item**

Wall mount, top with profile edge detail, fabric tack panel (fabric not included, COM must be acrylic backed). Open center storage, one adjustable shelf, open project shelf storage 3" high. Cabinet back unfinished. Optional task lights available, see HBF Casegood Accessories.

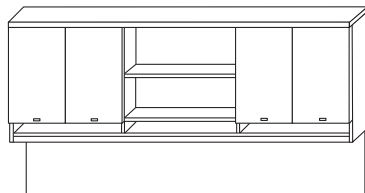

<b>ME64F2-PWP</b>	3 yds	<b>5711</b>	<b>6168</b>	<b>6854</b>	78	15 3/4	57 3/8	220
<b>ME64B2-PWP</b>	3 yds	<b>5989</b>	<b>6469</b>	<b>7187</b>	84	15 3/4	57 3/8	220
<b>ME64C2-PWP</b>	3 yds	<b>6247</b>	<b>6747</b>	<b>7496</b>	90	15 3/4	57 3/8	230
<b>ME64D2-PWP</b>	3 1/4 yds	<b>6515</b>	<b>7036</b>	<b>7818</b>	96	15 3/4	57 3/8	230
<b>ME64G2-PWP</b>	3 1/2 yds	<b>6783</b>	<b>7325</b>	<b>8139</b>	102	15 3/4	57 3/8	240
<b>ME64E2-PWP</b>	3 3/4 yds	<b>7050</b>	<b>7614</b>	<b>8460</b>	108	15 3/4	57 3/8	240
<b>ME64H2-PWP</b>	4 1/4 yds	<b>7287</b>	<b>7870</b>	<b>8745</b>	114	15 3/4	57 3/8	250
<b>ME64J2-PWP</b>	4 1/4 yds	<b>7524</b>	<b>8126</b>	<b>9029</b>	120	15 3/4	57 3/8	250

**Veneer species must be noted on each line item**

Wall mount, top with profile edge detail, fabric tack panel (fabric not included, COM must be acrylic backed). Open center storage, one adjustable shelf, open project shelf storage 3" high. Cabinet back unfinished. Optional task lights available, see HBF Casegood Accessories.

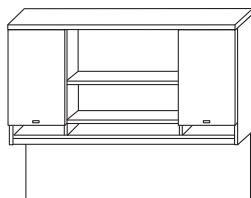

<b>ME65A2-PWP</b>		<b>5310</b>	<b>5734</b>	<b>6372</b>	72	15 3/4	57 3/8	200
-------------------	--	-------------	-------------	-------------	----	--------	--------	-----

**Veneer species must be noted on each line item**

Wall mount, top with profile edge detail, finished wood panel. Open center storage, one adjustable shelf, open project shelf storage 3" high. Cabinet back unfinished. Optional task lights available, see HBF Casegood Accessories.

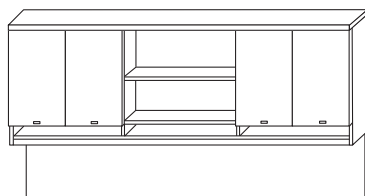

<b>ME65F2-PWP</b>		<b>6082</b>	<b>6569</b>	<b>7299</b>	78	15 3/4	57 3/8	220
<b>ME65B2-PWP</b>		<b>6391</b>	<b>6902</b>	<b>7669</b>	84	15 3/4	57 3/8	220
<b>ME65C2-PWP</b>		<b>6659</b>	<b>7192</b>	<b>7991</b>	90	15 3/4	57 3/8	230
<b>ME65D2-PWP</b>		<b>6937</b>	<b>7492</b>	<b>8324</b>	96	15 3/4	57 3/8	230
<b>ME65G2-PWP</b>		<b>7246</b>	<b>7826</b>	<b>8695</b>	102	15 3/4	57 3/8	240
<b>ME65E2-PWP</b>		<b>7514</b>	<b>8115</b>	<b>9017</b>	108	15 3/4	57 3/8	240
<b>ME65H2-PWP</b>		<b>7751</b>	<b>8371</b>	<b>9301</b>	114	15 3/4	57 3/8	250
<b>ME65J2-PWP</b>		<b>7988</b>	<b>8627</b>	<b>9585</b>	120	15 3/4	57 3/8	250

**Veneer species must be noted on each line item**

Wall mount, top with profile edge detail, finished wood panel. Open center storage, one adjustable shelf, open project shelf storage 3" high. Cabinet back unfinished. Optional task lights available, see HBF Casegood Accessories.

**Double high overhead cabinets to be used with double high vertical cabinets.  
Installation and maintenance of wall mounted overhead cabinets are the sole responsibility of the customer.  
Proper installation is crucial to prevent personal injury.**

**Veneer species must be noted on each line item**

<u>Veneer Grade 1</u>	<u>Veneer Grade 2</u>	<u>Veneer Grade 3</u>
Cherry	Rift Oak	Anigre
Maple	Sapele	
Ligno-Grain		
Walnut		

# HBF Mercer Casegoods - Vertical Storage

Style Number	Fabric	List Price			Dimensions			Weight
		Veneer 1	Veneer 2	Veneer 3	OW	OD	OH	

## Vertical Storage Cabinets, Top without Profile Edge Detail

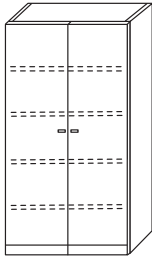

ME70M		3291	3554	3949	30	24 3/4	71 1/2	71	205
ME70N		3435	3710	4122	36	24 3/4	71 1/2	71	237

**Veneer species must be noted on each line item**

Storage unit, four adjustable shelves, flush top without profile edge detail, cabinet back unfinished.

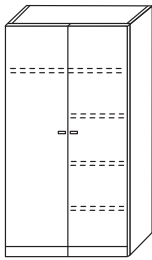

ME71M		3517	3799	4221	30	24 3/4	71 1/2	71	205
ME71N		3651	3943	4382	36	24 3/4	71 1/2	71	237

**Veneer species must be noted on each line item**

Storage/wardrobe unit, four adjustable shelves and a hat shelf with wardrobe rod, shelves are field changeable from left to right, flush top without profile edge detail, cabinet back unfinished.

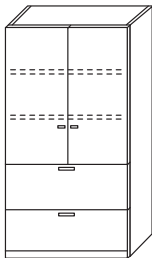

ME72M		4032	4355	4839	30	24 3/4	71 1/2	71	205
ME72N		4156	4489	4987	36	24 3/4	71 1/2	71	237

**Veneer species must be noted on each line item**

Storage unit, two adjustable shelves above and two locking lateral file drawers below. Flush top without profile edge detail, cabinet back unfinished.

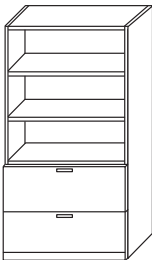

ME73M		3723	4021	4468	30	24 3/4	71 1/2	71	205
ME73N		3868	4177	4641	36	24 3/4	71 1/2	71	237

**Veneer species must be noted on each line item**

Storage unit, two open adjustable shelves above and two locking lateral file drawers below. Flush top without profile edge detail, cabinet back unfinished.

**Veneer species must be noted on each line item**

<u>Veneer Grade 1</u>	<u>Veneer Grade 2</u>	<u>Veneer Grade 3</u>
Cherry	Rift Oak	Anigre
Maple	Sapele	
Ligno-Grain		
Walnut		

# HBF Mercer Casegoods - Vertical Storage

Style Number	Fabric	List Price			Dimensions			Weight
		Veneer 1	Veneer 2	Veneer 3	OW	OD	OH	

## Vertical Storage Cabinets, Top without Profile Edge Detail

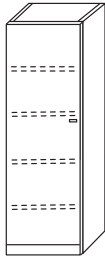

MELH70P	(left hinge)	2724	2942	3269	18	24 3/4	71 1/2	71	176
MERH70P	(right hinge)	2724	2942	3269	18	24 3/4	71 1/2	71	176

**Veneer species must be noted on each line item**

Storage unit, four adjustable shelves. Flush top without profile edge detail, cabinet back unfinished.

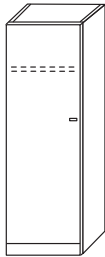

MELH71P	(left hinge)	2518	2720	3022	18	24 3/4	71 1/2	71	176
MERH71P	(right hinge)	2518	2720	3022	18	24 3/4	71 1/2	71	176

**Veneer species must be noted on each line item**

Wardrobe unit, hat shelf and wardrobe rod. Flush top without profile edge detail, cabinet back unfinished.

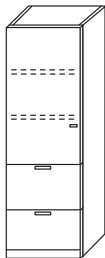

MELH72P	(left hinge)	3342	3610	4011	18	24 3/4	71 1/2	71	176
MERH72P	(right hinge)	3342	3610	4011	18	24 3/4	71 1/2	71	176

**Veneer species must be noted on each line item**

Storage unit, two adjustable shelves above and two locking file drawers below. Flush top without profile edge detail, cabinet back unfinished.



ME73P		2879	3109	3455	18	24 3/4	71 1/2	71	176
-------	--	------	------	------	----	--------	--------	----	-----

**Veneer species must be noted on each line item**

Storage unit, two open adjustable shelves above and two locking file drawers below. Flush top without profile edge detail, cabinet back unfinished.

**Veneer species must be noted on each line item**

<u>Veneer Grade 1</u>	<u>Veneer Grade 2</u>	<u>Veneer Grade 3</u>
Cherry	Rift Oak	Anigre
Maple	Sapele	
Ligno-Grain		
Walnut		

# HBF Mercer Casegoods - Vertical Storage

Style Number	List Price			Dimensions				Weight
	Veneer 1	Veneer 2	Veneer 3	OW	OD	OH:M	OH:A/F	

## Vertical Storage Cabinets, Top with Profile Edge Detail

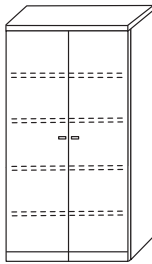

ME70A	3620	3910	4345	30	24 3/4	73	72 1/4	205
ME70B	3806	4110	4567	36	24 3/4	73	72 1/4	237

**Veneer species must be noted on each line item**

Storage unit, four adjustable shelves. Top with profile edge detail, cabinet back unfinished.

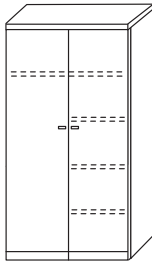

ME71A	3837	4144	4604	30	24 3/4	73	72 1/4	205
ME71B	4032	4355	4839	36	24 3/4	73	72 1/4	237

**Veneer species must be noted on each line item**

Storage/Wardrobe unit, four adjustable shelves and a hat shelf with wardrobe rod, shelves are field changeable left to right. Top with profile edge detail, cabinet back unfinished.

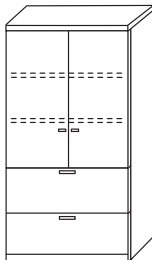

ME72A	4403	4756	5284	30	24 3/4	73	72 1/4	205
ME72B	4527	4889	5432	36	24 3/4	73	72 1/4	237

**Veneer species must be noted on each line item**

Storage unit, two adjustable shelves above and two locking lateral file drawers below. Top with profile edge detail, cabinet back unfinished.

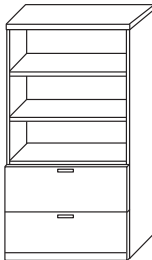

ME73A	4053	4377	4864	30	24 3/4	73	72 1/4	205
ME73B	4238	4578	5086	36	24 3/4	73	72 1/4	237

**Veneer species must be noted on each line item**

Storage unit, two open adjustable shelves above and two locking lateral file drawers below. Top with profile edge detail, cabinet back unfinished.

**Veneer species must be noted on each line item**

<u>Veneer Grade 1</u>	<u>Veneer Grade 2</u>	<u>Veneer Grade 3</u>
Cherry	Rift Oak	Anigre
Maple	Sapele	
Ligno-Grain		
Walnut		

# HBF Mercer Casegoods - Vertical Storage

Style Number		List Price			Dimensions				Weight
		Veneer 1	Veneer 2	Veneer 3	OW	OD	OH:M	OH:A/F	

## Vertical Storage Cabinets, Top with Profile Edge Detail

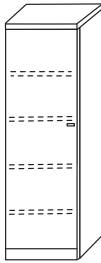

MELH70C	(left hinge)	3002	3243	3603	18	24 3/4	73	72 1/4	176
MERH70C	(right hinge)	3002	3243	3603	18	24 3/4	73	72 1/4	176

Veneer species must be noted on each line item

Storage unit, four adjustable shelves. Top with profile edge detail, cabinet back unfinished.

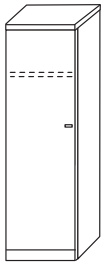

MELH71C	(left hinge)	2796	3020	3356	18	24 3/4	73	72 1/4	176
MERH71C	(right hinge)	2796	3020	3356	18	24 3/4	73	72 1/4	176

Veneer species must be noted on each line item

Wardrobe unit, hat shelf and wardrobe rod. Top with profile edge detail, cabinet back unfinished.

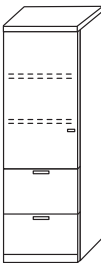

MELH72C	(left hinge)	3620	3910	4345	18	24 3/4	73	72 1/4	176
MERH72C	(right hinge)	3620	3910	4345	18	24 3/4	73	72 1/4	176

Veneer species must be noted on each line item

Storage unit, two adjustable shelves above and two locking file drawers below. Top with profile edge detail, cabinet back unfinished.



ME73C		3147	3398	3776	18	24 3/4	73	72 1/4	176
-------	--	------	------	------	----	--------	----	--------	-----

Veneer species must be noted on each line item

Storage unit, two open adjustable shelves above and two locking file drawers below. Top with profile edge detail, cabinet back unfinished.

### Veneer species must be noted on each line item

Veneer Grade 1	Veneer Grade 2	Veneer Grade 3
Cherry	Rift Oak	Anigre
Maple	Sapele	
Ligno-Grain		
Walnut		



# HBF Mercer Casegoods - Vertical Storage

Style Number	List Price			Dimensions				Weight
	Veneer 1	Veneer 2	Veneer 3	OW	OD	OH:M	OH:A/F	

## Vertical Storage Cabinets, Top without Profile Edge Detail (Double High)

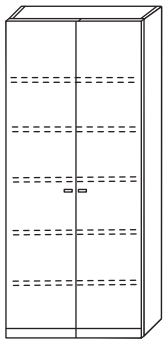

ME70M2	4455	4811	5346	30	24 3/4	85 5/16	84 11/16	277
ME70N2	4650	5022	5581	36	24 3/4	85 5/16	84 11/16	320

**Veneer species must be noted on each line item**

Storage unit, five adjustable shelves, flush top without profile edge detail, cabinet back unfinished.

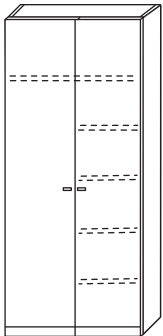

ME71M2	(left hinge)	4753	5134	5704	30	24 3/4	85 5/16	84 11/16	277
ME71N2	(right hinge)	4939	5334	5927	36	24 3/4	85 5/16	84 11/16	320

**Veneer species must be noted on each line item**

Storage/wardrobe unit, five adjustable shelves and a hat shelf with wardrobe rod, shelves are field changeable from left to right, flush top without profile edge detail, cabinet back unfinished.

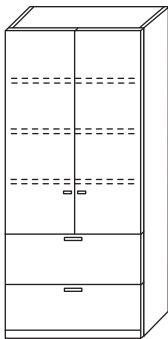

ME72M2	5444	5879	6532	30	24 3/4	85 5/16	84 11/16	277
ME72N2	5619	6068	6742	36	24 3/4	85 5/16	84 11/16	320

**Veneer species must be noted on each line item**

Storage unit, three adjustable shelves above and two locking lateral file drawers below. Flush top without profile edge detail, cabinet back unfinished.



ME73M2	5032	5434	6038	30	24 3/4	85 5/16	84 11/16	277
ME73N2	5227	5645	6273	36	24 3/4	85 5/16	84 11/16	320

**Veneer species must be noted on each line item**

Storage unit, three open adjustable shelves above and two locking lateral file drawers below. Flush top without profile edge detail, cabinet back unfinished.

**Veneer species must be noted on each line item**

<u>Veneer Grade 1</u>	<u>Veneer Grade 2</u>	<u>Veneer Grade 3</u>
Cherry	Rift Oak	Anigre
Maple	Sapele	
Ligno-Grain		
Walnut		

# HBF Mercer Casegoods - Vertical Storage

Style Number	List Price			Dimensions				Weight
	Veneer 1	Veneer 2	Veneer 3	OW	OD	OH:M	OH:A/F	

## Vertical Storage Cabinets, Top without Profile Edge Detail (Double High)

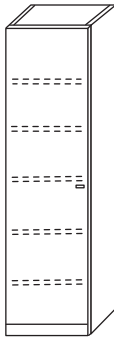

MELH70P2	(left hinge)	3672	3966	4406	18	24 3/4	85 5/16	84 11/16	237
MERH70P2	(right hinge)	3672	3966	4406	18	24 3/4	85 5/16	84 11/16	237

**Veneer species must be noted on each line item**

Storage unit, five adjustable shelves. Flush top without profile edge detail, cabinet back unfinished.

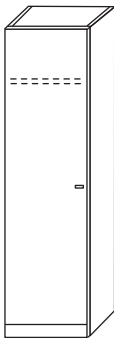

MELH71P2	(left hinge)	3414	3688	4097	18	24 3/4	85 5/16	84 11/16	237
MERH71P2	(right hinge)	3414	3688	4097	18	24 3/4	85 5/16	84 11/16	237

**Veneer species must be noted on each line item**

Wardrobe unit, hat shelf and wardrobe rod. Flush top without profile edge detail, cabinet back unfinished.

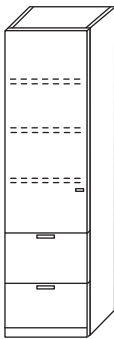

MELH72P2	(left hinge)	4517	4878	5420	18	24 3/4	85 5/16	84 11/16	237
MERH72P2	(right hinge)	4517	4878	5420	18	24 3/4	85 5/16	84 11/16	237

**Veneer species must be noted on each line item**

Storage unit, three adjustable shelves above and two locking file drawers below. Flush top without profile edge detail, cabinet back unfinished.

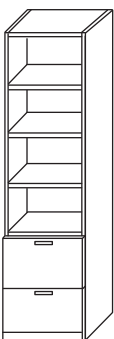

ME73P2		3868	4177	4641	18	24 3/4	85 5/16	84 11/16	237
--------	--	------	------	------	----	--------	---------	----------	-----

**Veneer species must be noted on each line item**

Storage unit, three open adjustable shelves above and two locking file drawers below. Flush top without profile edge detail, cabinet back unfinished.

**Veneer species must be noted on each line item**

<u>Veneer Grade 1</u>	<u>Veneer Grade 2</u>	<u>Veneer Grade 3</u>
Cherry	Rift Oak	Anigre
Maple	Sapele	
Ligno-Grain		
Walnut		

# HBF Mercer Casegoods - Vertical Storage

Style Number	List Price			Dimensions				Weight
	Veneer 1	Veneer 2	Veneer 3	OW	OD	OH:M	OH:A/F	

## Vertical Storage Cabinets, Top with Profile Edge Detail (Double High)

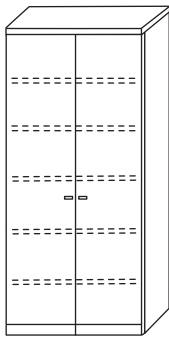

<b>ME70A2</b>	<b>4887</b>	<b>5278</b>	<b>5865</b>	30	24 3/4	86 11/16	86 1/16	277
<b>ME70B2</b>	<b>5145</b>	<b>5556</b>	<b>6174</b>	36	24 3/4	86 11/16	86 1/16	320

**Veneer species must be noted on each line item**

Storage unit, five adjustable shelves. Top with profile edge detail, cabinet back unfinished.

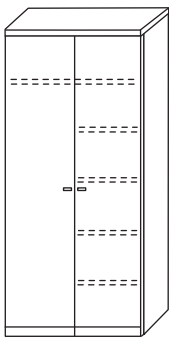

<b>ME71A2</b>	<b>5186</b>	<b>5601</b>	<b>6223</b>	30	24 3/4	86 11/16	86 1/16	277
<b>ME71B2</b>	<b>5444</b>	<b>5879</b>	<b>6532</b>	36	24 3/4	86 11/16	86 1/16	320

**Veneer species must be noted on each line item**

Storage/Wardrobe unit, five adjustable shelves and a hat shelf with wardrobe rod, shelves are field changeable left to right. Top with profile edge detail, cabinet back unfinished.

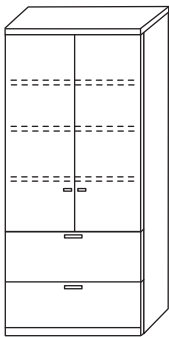

<b>ME72A2</b>	<b>5866</b>	<b>6335</b>	<b>7039</b>	30	24 3/4	86 11/16	86 1/16	277
<b>ME72B2</b>	<b>6113</b>	<b>6602</b>	<b>7336</b>	36	24 3/4	86 11/16	86 1/16	320

**Veneer species must be noted on each line item**

Storage unit, three adjustable shelves above and two locking lateral file drawers below. Top with profile edge detail, cabinet back unfinished.



<b>ME73A2</b>	<b>5474</b>	<b>5912</b>	<b>6569</b>	30	24 3/4	86 11/16	86 1/16	277
<b>ME73B2</b>	<b>5722</b>	<b>6179</b>	<b>6866</b>	36	24 3/4	86 11/16	86 1/16	320

**Veneer species must be noted on each line item**

Storage unit, three open adjustable shelves above and two locking lateral file drawers below. Top with profile edge detail, cabinet back unfinished.

**Veneer species must be noted on each line item**

<u>Veneer Grade 1</u>	<u>Veneer Grade 2</u>	<u>Veneer Grade 3</u>
Cherry	Rift Oak	Anigre
Maple	Sapele	
Ligno-Grain		
Walnut		

# HBF Mercer Casegoods - Vertical Storage

Style Number	List Price			Dimensions				Weight
	Veneer 1	Veneer 2	Veneer 3	OW	OD	OH:M	OH:A/F	

## Vertical Storage Cabinets, Top with Profile Edge Detail (Double High)

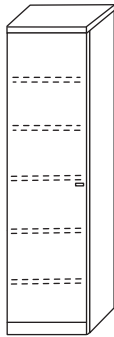

MELH70C2	(left hinge)	4053	4377	4864	18	24 3/4	86 11/16	86 1/16	237
MERH70C2	(right hinge)	4053	4377	4864	18	24 3/4	86 11/16	86 1/16	237

**Veneer species must be noted on each line item**

Storage unit, five adjustable shelves. Top with profile edge detail, cabinet back unfinished.

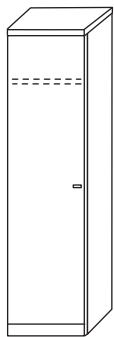

MELH71C2	(left hinge)	3775	4077	4530	18	24 3/4	86 11/16	86 1/16	237
MERH71C2	(right hinge)	3775	4077	4530	18	24 3/4	86 11/16	86 1/16	237

**Veneer species must be noted on each line item**

Wardrobe unit, hat shelf and wardrobe rod. Top with profile edge detail, cabinet back unfinished.

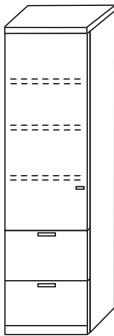

MELH72C2	(left hinge)	4877	5267	5852	18	24 3/4	86 11/16	86 1/16	237
MERH72C2	(right hinge)	4877	5267	5852	18	24 3/4	86 11/16	86 1/16	237

**Veneer species must be noted on each line item**

Storage unit, three adjustable shelves above and two locking file drawers below. Top with profile edge detail, cabinet back unfinished.

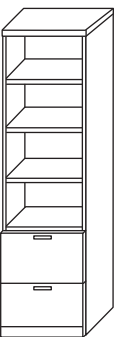

ME73C2		4238	4578	5086	18	24 3/4	86 11/16	86 1/16	237
--------	--	------	------	------	----	--------	----------	---------	-----

**Veneer species must be noted on each line item**

Storage unit, three open adjustable shelves above and two locking file drawers below. Top with profile edge detail, cabinet back unfinished.

**Veneer species must be noted on each line item**

<u>Veneer Grade 1</u>	<u>Veneer Grade 2</u>	<u>Veneer Grade 3</u>
Cherry	Rift Oak	Anigre
Maple	Sapele	
Ligno-Grain		
Walnut		

# HBF Mercer Casegoods - Bookcases

Style Number	List Price			Dimensions					
	Veneer 1	Veneer 2	Veneer 3	OW	OD	OH:M	OH:A/F	Weight	

## Bookcases

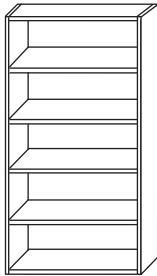

ME75MB	2941	3176	3529	30	14 7/8	71 1/2	71	195
ME75NB	3002	3243	3603	36	14 7/8	71 1/2	71	227

Veneer species must be noted on each line item

Flush top without profile edge detail, four adjustable shelves, standard black unfinished back panel.

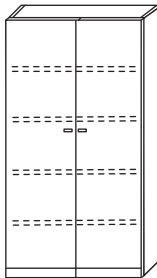

ME76MB	3167	3421	3801	30	15 3/4	71 1/2	71	205
ME76NB	3291	3554	3949	36	15 3/4	71 1/2	71	237

Veneer species must be noted on each line item

Flush top without profile edge detail, four adjustable shelves, standard black unfinished back panel.

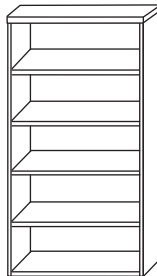

ME75AB	3167	3421	3801	30	14 7/8	73	72 1/4	195
ME75BB	3291	3554	3949	36	14 7/8	73	72 1/4	227

Veneer species must be noted on each line item

Top with profile edge detail, four adjustable shelves, standard black unfinished back panel.

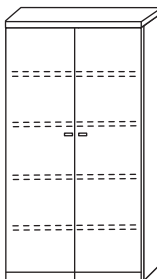

ME76AB	3404	3676	4085	30	15 3/4	73	72 1/4	205
ME76BB	3559	3843	4270	36	15 3/4	73	72 1/4	237

Veneer species must be noted on each line item

Top with profile edge detail, four adjustable shelves, standard black unfinished back panel.

Veneer species must be noted on each line item

Veneer Grade 1	Veneer Grade 2	Veneer Grade 3
Cherry	Rift Oak	Anigre
Maple	Sapele	
Ligno-Grain		
Walnut		

# HBF Mercer Casegoods - Bookcases

Style Number	List Price			Dimensions				
	Veneer 1	Veneer 2	Veneer 3	OW	OD	OH:M	OH:A/F	Weight

## Bookcases (Double High)

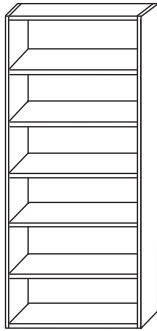

ME75MB2	3981	4299	4777	30	14 7/8	85 5/16	84 11/16	264
ME75NB2	4053	4377	4864	36	14 7/8	85 5/16	84 11/16	307

Veneer species must be noted on each line item

Flush top without profile edge detail, five adjustable shelves, standard black unfinished back panel.

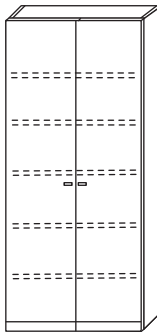

ME76MB2	4280	4622	5136	30	15 3/4	85 5/16	84 11/16	277
ME76NB2	4455	4811	5346	36	15 3/4	85 5/16	84 11/16	320

Veneer species must be noted on each line item

Flush top without profile edge detail, five adjustable shelves, standard black unfinished back panel.

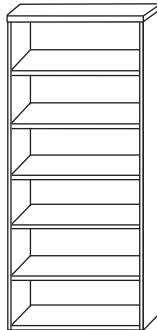

ME75AB2	4280	4622	5136	30	14 7/8	86 11/16	86 1/16	264
ME75BB2	4414	4767	5296	36	14 7/8	86 11/16	86 1/16	307

Veneer species must be noted on each line item

Top with profile edge detail, five adjustable shelves, standard black unfinished back panel.

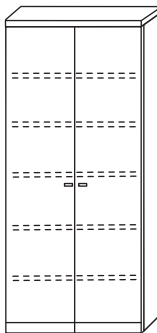

ME76AB2	4599	4967	5519	30	15 3/4	86 11/16	86 1/16	277
ME76BB2	4815	5200	5778	36	15 3/4	86 11/16	86 1/16	320

Veneer species must be noted on each line item

Top with profile edge detail, five adjustable shelves, standard black unfinished back panel.

Veneer species must be noted on each line item

Veneer Grade 1	Veneer Grade 2	Veneer Grade 3
Cherry	Rift Oak	Anigre
Maple	Sapele	
Ligno-Grain		
Walnut		

# HBF Mercer Casegoods - Bookcases

Style Number	List Price			Dimensions				Weight
	Veneer 1	Veneer 2	Veneer 3	OW	OD	OH:M	OH:A/F	

## Bookcases

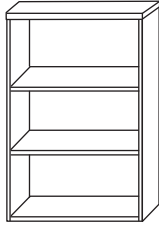

ME75A	2426	2620	2911	30	14 7/8	44	43 3/8	109
ME75B	2570	2775	3084	36	14 7/8	44	43 3/8	131

Veneer species must be noted on each line item

Top profile edge detail, two adjustable shelves, standard black unfinished back.

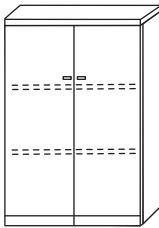

ME76A	2899	3131	3479	30	15 3/4	44	43 3/8	109
ME76B	3044	3287	3652	36	15 3/4	44	43 3/8	131

Veneer species must be noted on each line item

Top profile edge detail, two adjustable shelves, standard black unfinished back.

## Lateral Files

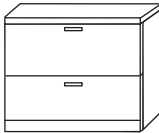

ME37A	2106	2275	2528	30	24	29	29	180
ME37B	2189	2364	2627	36	24	29	29	192
ME37B3	3384	3654	4060	36	24	42 1/4	42 1/4	205
ME37B4	3816	4121	4579	36	24	55 3/4	55 3/4	230
ME38A	2652	2864	3183	30	24 3/4	29	29	182
ME38B	2735	2953	3282	36	24 3/4	29	29	192
ME38B3	3940	4255	4728	36	24 3/4	42 1/4	42 1/4	207
ME38B4	4352	4700	5222	36	24 3/4	55 3/4	55 3/4	232

Veneer species must be noted on each line item

37 lateral files have a standard black unfinished back panel.

38 lateral files have a finished back panel.

37B3 and 38B3 are three high lateral files.

37B4 and 38B4 are four high lateral files.

Veneer species must be noted on each line item

Veneer Grade 1	Veneer Grade 2	Veneer Grade 3
Cherry	Rift Oak	Anigre
Maple	Sapele	
Ligno-Grain		
Walnut		

# HBF Mercer Casegoods - Reception Desks

Style Number	List Price			Dimensions			Weight
	Veneer 1	Veneer 2	Veneer 3	OW	OD	OH	

## Rectangular Reception Desks, Recessed Modesty Panel

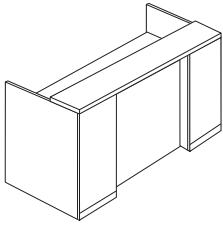

<b>ME81A</b>	<b>8420</b>	<b>9094</b>	<b>10104</b>	72	35	41 3/8	569
<b>ME81B</b>	<b>9244</b>	<b>9984</b>	<b>11093</b>	84	35	41 3/8	589

**Veneer species must be noted on each line item**

Transaction shelf. 11" OH from bottom of transaction shelf to top of worksurface. Worksurface recessed 1 1/4" from modesty panel to provide access for wire management, grommets not required in desk. One desk pedestal and location (right or left) must be specified. Pedestals must be 18" box/box/file or 18" file/file.

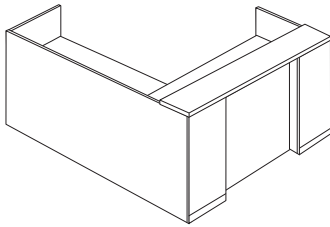

<b>ME82A</b>	<b>9677</b>	<b>10451</b>	<b>11612</b>	72	84 3/8	41 3/8	869
<b>ME82B</b>	<b>10501</b>	<b>11341</b>	<b>12601</b>	84	84 3/8	41 3/8	890

**Veneer species must be noted on each line item**

Transaction shelf, desk only. 11" OH from bottom of transaction shelf to top of worksurface. Worksurface recessed 1 1/4" from modesty panel to provide access for wire management, grommets not required in desk. One desk pedestal and one return pedestal, along with hand of return, must be specified. Pedestals must be 18" box/box/file or 18" file/file.

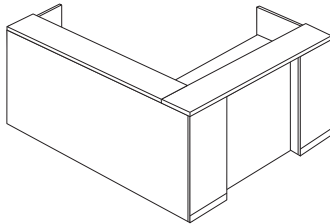

<b>ME83A</b>	<b>9986</b>	<b>10785</b>	<b>11983</b>	72	84 3/8	41 3/8	915
<b>ME83B</b>	<b>10861</b>	<b>11730</b>	<b>13034</b>	84	84 3/8	41 3/8	935

**Veneer species must be noted on each line item**

Transaction shelf, desk and return. 11" OH from bottom of transaction shelf to top of worksurface. Worksurface recessed 1 1/4" from modesty panel to provide access for wire management, grommets not required in desk. One desk pedestal and one return pedestal, along with hand of return, must be specified. Pedestals must be 18" box/box/file or 18" file/file.

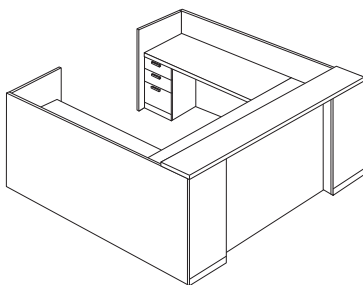

<b>ME87C</b>	<b>12242</b>	<b>13221</b>	<b>14690</b>	90	84 3/8	41 3/8	910
--------------	--------------	--------------	--------------	----	--------	--------	-----

**Veneer species must be noted on each line item**

Transaction shelf, desk only. 11" OH from bottom of transaction shelf to top of worksurface. Worksurface recessed 1 1/4" from modesty panel to provide access for wire management, grommets not required in desk. Both left and right return pedestals must be specified. Pedestals must be 18" box/box/file or 18" file/file.

**Veneer species must be noted on each line item**

<u>Veneer Grade 1</u>	<u>Veneer Grade 2</u>	<u>Veneer Grade 3</u>
Cherry	Rift Oak	Anigre
Maple	Sapele	
Ligno-Grain		
Walnut		



# HBF Mercer Casegoods - Reception Desks

Style Number	List Price			Dimensions			Weight
	Veneer 1	Veneer 2	Veneer 3	OW	OD	OH	

## Rectangular Reception Desks, Recessed Modesty Panel

<b>ME88C</b>	<b>12952</b>	<b>13988</b>	<b>15543</b>	90	84 3/8	41 3/8	955
--------------	--------------	--------------	--------------	----	--------	--------	-----

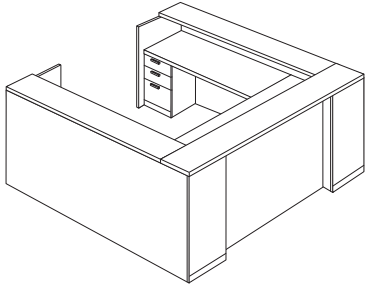

**Veneer species must be noted on each line item**

Transaction shelf, desk and both returns. 11" OH from bottom of transaction shelf to top of worksurface. Worksurface recessed 1 1/4" from modesty panel to provide access for wire management, grommets not required in desk. Both left and right return pedestals must be specified. Pedestals must be 18" box/box/file or 18" file/file.

<b>ME87AR</b>	<b>12849</b>	<b>13877</b>	<b>15419</b>	72	107	41 3/8	1289
---------------	--------------	--------------	--------------	----	-----	--------	------

<b>ME87BR</b>	<b>13591</b>	<b>14678</b>	<b>16309</b>	84	107	41 3/8	1319
---------------	--------------	--------------	--------------	----	-----	--------	------

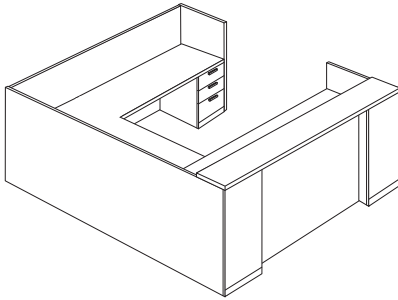

**Veneer species must be noted on each line item**

Transaction shelf, desk only. 11" OH from bottom of transaction shelf to top of worksurface. Worksurface recessed 1 1/4" from modesty panel to provide access for wire management, grommets not required in desk. Desk and credenza pedestal along with hand of bridge must be specified. Pedestals must be 18" box/box/file or 18" file/file.

<b>ME88AR</b>	<b>13210</b>	<b>14267</b>	<b>15852</b>	72	107	41 5/8	1335
---------------	--------------	--------------	--------------	----	-----	--------	------

<b>ME88BR</b>	<b>13951</b>	<b>15067</b>	<b>16742</b>	84	107	41 5/8	1385
---------------	--------------	--------------	--------------	----	-----	--------	------

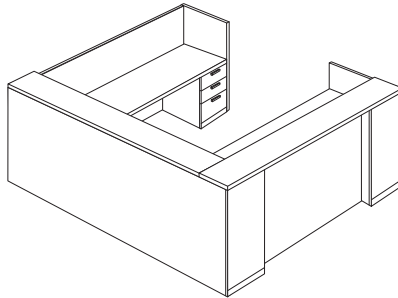

**Veneer species must be noted on each line item**

Transaction shelf, desk and return. 11" OH from bottom of transaction shelf to top of worksurface. Worksurface recessed 1 1/4" from modesty panel to provide access for wire management, grommets not required in desk. Desk and credenza pedestal along with hand of bridge must be specified. Pedestals must be 18" box/box/file or 18" file/file.

## Bow Front Reception Desks, Recessed Modesty Panel

<b>ME84A</b>	<b>9605</b>	<b>10373</b>	<b>11526</b>	72	39	41 3/8	569
--------------	-------------	--------------	--------------	----	----	--------	-----

<b>ME84B</b>	<b>10470</b>	<b>11308</b>	<b>12564</b>	84	39	41 3/8	589
--------------	--------------	--------------	--------------	----	----	--------	-----

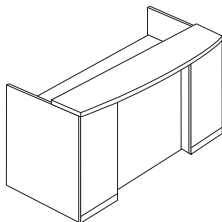

**Veneer species must be noted on each line item**

Transaction shelf. 11" OH from bottom of transaction shelf to top of worksurface. Worksurface recessed 1 1/4" from modesty panel to provide access for wire management, grommets not required in desk. Desk pedestal and location (left or right) must be specified. Pedestals must be 18" box/box/file or 18" file/file.

**Veneer species must be noted on each line item**

<u>Veneer Grade 1</u>	<u>Veneer Grade 2</u>	<u>Veneer Grade 3</u>
Cherry	Rift Oak	Anigre
Maple	Sapele	
Ligno-Grain		
Walnut		

# HBF Mercer Casegoods - Reception Desks

Style Number	List Price			Dimensions			Weight
	Veneer 1	Veneer 2	Veneer 3	OW	OD	OH	

## Bow Front Reception Desks, Recessed Modesty Panel

<b>ME85A</b>	<b>10861</b>	<b>11730</b>	<b>13034</b>	72	88 3/8	41 3/8	869
<b>ME85B</b>	<b>11685</b>	<b>12620</b>	<b>14022</b>	84	88 3/8	41 3/8	890

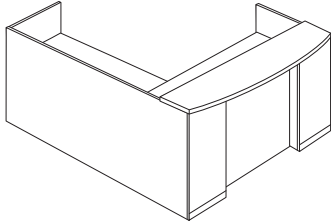

**Veneer species must be noted on each line item**

Transaction shelf, desk only. 11" OH from bottom of transaction shelf to top of worksurface. Worksurface recessed 1 1/4" from modesty panel to provide access for wire management, grommets not required in desk. One desk pedestal and one return pedestal, along with hand of return, must be specified. Pedestals must be 18" box/box/file or 18" file/file.

<b>ME86A</b>	<b>11222</b>	<b>12120</b>	<b>13466</b>	72	88 3/8	41 3/8	915
<b>ME86B</b>	<b>12046</b>	<b>13010</b>	<b>14455</b>	84	88 3/8	41 3/8	935

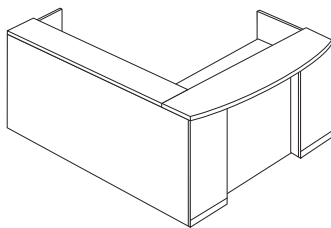

**Veneer species must be noted on each line item**

Transaction shelf, desk and return. 11" OH from bottom of transaction shelf to top of worksurface. Worksurface recessed 1 1/4" from modesty panel to provide access for wire management, grommets not required in desk. One desk pedestal and one return pedestal, along with hand of return, must be specified. Pedestals must be 18" box/box/file or 18" file/file.

## Rectangular Reception Desks, Recessed Modesty Panel

<b>ME89C</b>	<b>13385</b>	<b>14456</b>	<b>16062</b>	90	88 3/8	41 3/8	910
--------------	--------------	--------------	--------------	----	--------	--------	-----

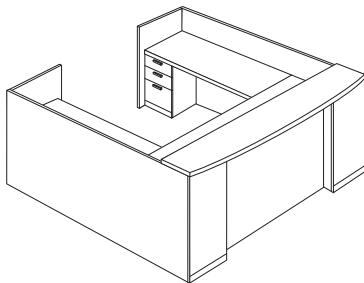

**Veneer species must be noted on each line item**

Transaction shelf, desk only. 11" OH from bottom of transaction shelf to top of worksurface. Worksurface recessed 1 1/4" from modesty panel to provide access for wire management, grommets not required in desk. Both left and right return pedestals must be specified. Pedestals must be 18" box/box/file or 18" file/file.

<b>ME90C</b>	<b>14157</b>	<b>15290</b>	<b>16989</b>	90	88 3/8	41 3/8	955
--------------	--------------	--------------	--------------	----	--------	--------	-----

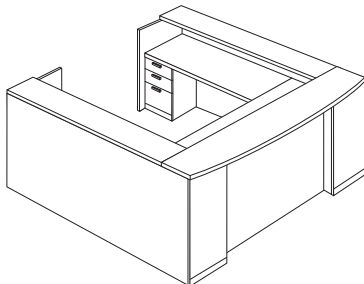

**Veneer species must be noted on each line item**

Transaction shelf, desk and both returns. 11" OH from bottom of transaction shelf to top of worksurface. Worksurface recessed 1 1/4" from modesty panel to provide access for wire management, grommets not required in desk. Both left and right return pedestals must be specified. Pedestals must be 18" box/box/file or 18" file/file.

**Veneer species must be noted on each line item**

<u>Veneer Grade 1</u>	<u>Veneer Grade 2</u>	<u>Veneer Grade 3</u>
Cherry	Rift Oak	Anigre
Maple	Sapele	
Ligno-Grain		
Walnut		

# HBF Mercer Casegoods - Reception Desks

Style Number	List Price			Dimensions			Weight
	Veneer 1	Veneer 2	Veneer 3	OW	OD	OH	

## Rectangular Reception Desks, Recessed Modesty Panel

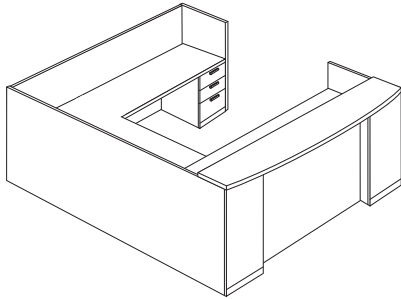

ME90AR	14085	15212	16902	72	111	41 3/8	1289
ME90BR	14858	16046	17829	84	111	41 3/8	1319

**Veneer species must be noted on each line item**

Transaction shelf, desk only. 11" OH from bottom of transaction shelf to top of worksurface. Worksurface recessed 1 1/4" from modesty panel to provide access for wire management, grommets not required in desk. Desk and credenza pedestal, along with hand of bridge, must be specified. Pedestals must be 18" box/box/file or 18" file/file.

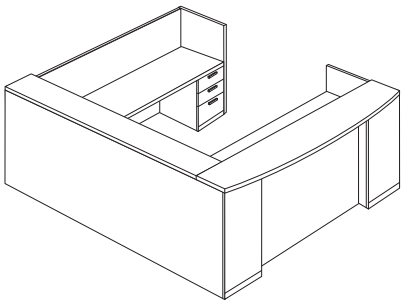

ME91AR	14446	15601	17335	72	111	41 3/8	1335
ME91BR	15218	16436	18262	84	111	41 3/8	1385

**Veneer species must be noted on each line item**

Transaction shelf, desk and return. 11" OH from bottom of transaction shelf to top of worksurface. Worksurface recessed 1 1/4" from modesty panel to provide access for wire management, grommets not required in desk. Desk and credenza pedestal, along with hand of bridge, must be specified. Pedestals must be 18" box/box/file or 18" file/file.

**Veneer species must be noted on each line item**

<u>Veneer Grade 1</u>	<u>Veneer Grade 2</u>	<u>Veneer Grade 3</u>
Cherry	Rift Oak	Anigre
Maple	Sapele	
Ligno-Grain		
Walnut		

# HBF Mercer Accessories

	Style Number	List Price	Dimensions			Weight
			OW	OD	OH	

## Stack Shelves

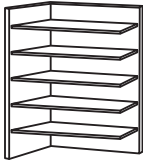

AC97A (S or B)	510	17 1/4	11 1/4	22	10
AC97B (S or B)	561	18	11 1/4	22	12

Indicate S for Satin Pewter powder coat shelves, B for Gloss Black powder coat shelves. Inside back and end are wood veneer panels and will be finished to match the casegood unit; outside back and end panels are standard black unfinished. AC97A is intended to be used with overhead cabinets with wood panel support; AC97B is used with wall mount overhead cabinets.

## Worksurface Shelves



AC97C (S or B)-36	438	36	9 1/4	3 1/4	24
AC97C (S or B)-42	438	42	9 1/4	3 1/4	25
AC97C (S or B)-48	438	48	9 1/4	3 1/4	26
AC97C (S or B)-54	438	54	9 1/4	3 1/4	28
AC97C (S or B)-60	489	60	9 1/4	3 1/4	30
AC97C (S or B)-66	489	66	9 1/4	3 1/4	31
AC97C (S or B)-72	489	72	9 1/4	3 1/4	32
AC97C (S or B)-78	561	78	9 1/4	3 1/4	34
AC97C (S or B)-84	561	84	9 1/4	3 1/4	36
AC97C (S or B)-90	561	90	9 1/4	3 1/4	38
AC97C (S or B)-96	561	96	9 1/4	3 1/4	40
AC97C (S or B)-102	613	102	9 1/4	3 1/4	42
AC97C (S or B)-108	613	108	9 1/4	3 1/4	44
AC97C (S or B)-114	613	114	9 1/4	3 1/4	46
AC97C (S or B)-120	613	120	9 1/4	3 1/4	48

Indicate S for Satin Pewter powder coat shelves, B for Gloss Black powder coat shelves. Shelf supports are Gloss Black powder coat.

## Pedestal Shelves (Set of Four)

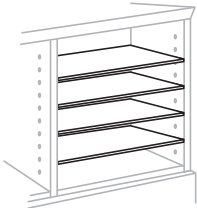

AC97D (S or B)-18	149	16 1/2	11 1/8		
AC97D (S or B)-30	149	13 7/8	11 1/8		
AC97D (S or B)-36	149	16 7/8	11 1/8		

Indicate S for Satin Pewter powder coat shelves, B for Gloss Black powder coat shelves.

## Pedestal Dividers (Set of Three)

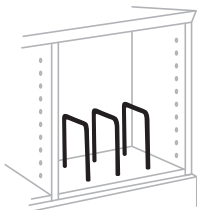

AC97E	36			6 1/4	
-------	----	--	--	-------	--

Metal wire dividers are Satin Nickel finish.

# HBF Mercer Conference Table Specifications

---

## Tables with Wood Bases

---

**Veneer** Premium grade flat cut veneer tops. Edges are bordered with solids or edgebands.

---

### Top Edge Detail

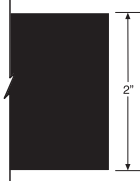

**Mercer**

---

**Worksurfaces** Mercer conference tables have a 2" (51mm) thick worksurface.

---

### Base Options

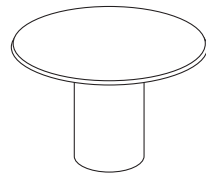

**Wood Column Base  
Round**

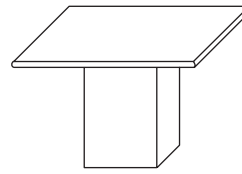

**Wood Column Base  
Square**

---

## Round and Square Tables with Single Wood Base

---

### Round Metal Grommet Power/Data Plate

Mercer Conference Tables with single wood bases are available with a compact power/data unit with a removable grommet cover. The round grommet is standard in HBF Satin Pewter powder coat finish. Grommet mounts flush with the top surface.

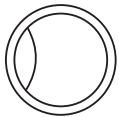

Tables specifying power/data capabilities will be equipped with a power/data unit that provides two (2) 110 volt electrical outlets and two (2) Cat.5E data jacks. This unit is hardwired and must be installed by a licensed electrician. Bases for tables with power/data access incorporate a hinged wood door on the side of the base to allow access to floor connections.



The electrical components provided within this group of furniture are engineered and manufactured in compliance with NEC regulation, however ***it is the responsibility of the specifier and contracted installer of the furniture to be aware of the local building and electrical restrictions.*** Electrical components meet both Chicago and New York electrical codes.

Additional voice/data inserts are available to replace the standard data jacks. These inserts can be ordered from Doug Mockett & Company ([www.mockett.com](http://www.mockett.com)) and installed as required by the end user's data specialist to accommodate specific requirements.

# HBF Mercer Conference Table Specifications

## Rectangular, Boat and Elliptical Tables with Multiple Wood Bases

### Round Metal Grommet Power/Data Plate

Mercer Conference Tables with multiple wood bases are available with either a round or oval grommet and power/data access units. Bases for tables with power/data access incorporate a hinged wood door on the side of the base to allow access to floor connections.

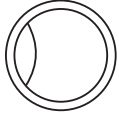

The removable round grommet is standard in HBF Satin Pewter powder coat finish and mounts flush with the top surface. The power/data unit provides two (2) 110 volt electrical outlets and two (2) Cat.5E data jacks. This unit is hardwired and must be installed by a licensed electrician.



The hinged oval grommet is standard in HBF Satin Pewter powder coat finish and mounts flush with the top surface. The power/data unit provides four (4) 110 volt electrical outlets and six (6) Cat.5E data jacks. This unit is hardwired and must be installed by a licensed electrician.

The electrical components provided within this group of furniture are engineered and manufactured in compliance with NEC regulation, however **it is the responsibility of the specifier and contracted installer of the furniture to be aware of the local building and electrical restrictions.** Electrical components meet both Chicago and New York electrical codes.

### Oval Metal Grommet Power/Data Plate

Additional voice/data inserts are available to replace the standard data jacks. These inserts can be ordered from Doug Mockett & Company ([www.mockett.com](http://www.mockett.com)) and installed as required by the end user's data specialist to accommodate specific requirements.

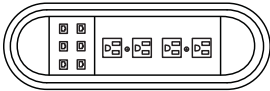
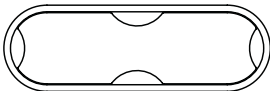

### Pedestal Bases

Round and square pedestal bases for tables specifying power/data access incorporate a hinged wood door to provide easy access to the inside of the base.

### Wood Column Base Placement

**Note: In style numbers "Y" equals a round base, "I" equals a square base.**

Wood Column Base Placement Locations						
Table Dimension	Top Size Designation		A	B	C	D
	Non-electrical	Electrical				
48" x 96"	E	S	15"	30"	(2) 18"	15"
48" x 108"	F	G	15"	42"	(2) 18"	15"
48" x 120"	G	V	15"	54"	(2) 18"	15"
54" x 120" ellipse	G	V	15"	(2) 25"	(2) 18"	18"
54" x 144"	H	W	17"	(2) 25"	(2) 18" / (1) 24"	15" / 18"
54" / 60" x 168"	J	X	18"	(2) 27"	(2) 24" / (1) 30"	12" / 15"
54" / 60" x 192"	K	Y	21"	(2) 36"	(2) 24" / (1) 30"	12" / 15"
60" x 216"	L	Z	27"	(2) 42"	(2) 24" / (1) 30"	15" / 18"

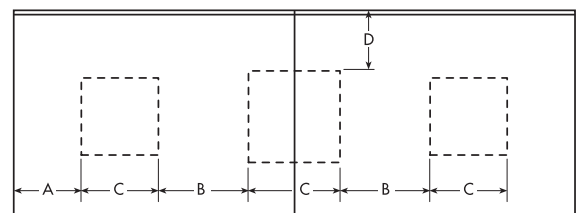
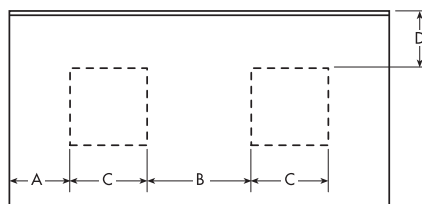

# HBF Mercer Conference Tables

Style Number	List Price			Dimensions			DIA	Weight
	Veneer 1	Veneer 2	Veneer 3	OW	OD	OH		

## Wood Bases

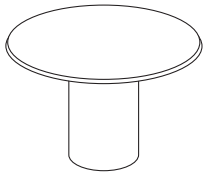

ME74A-Y	3045	3289	3654			29	42	120
ME74B-Y	3255	3515	3906			29	48	133
ME74C-Y	3500	3780	4200			29	54	149
ME74D-Y	3780	4082	4536			29	60	165

Veneer species must be noted on each line item

Wood column base.

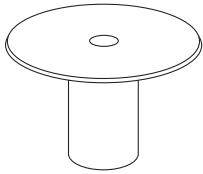

ME74A-YRH1	3780	4082	4536			29	42	130
ME74B-YRH1	3990	4309	4788			29	48	143
ME74C-YRH1	4235	4574	5082			29	54	159
ME74D-YRH1	4515	4876	5418			29	60	175

Veneer species must be noted on each line item

Wood column base, round electrical access grommet.

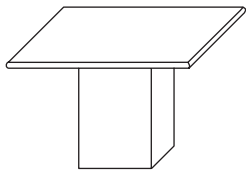

ME77A-I	2785	3008	3342	42	42	29		132
ME77B-I	2990	3229	3588	48	48	29		148
ME77C-I	3230	3488	3876	54	54	29		168
ME77D-I	3500	3780	4200	60	60	29		182

Veneer species must be noted on each line item

Wood column base.

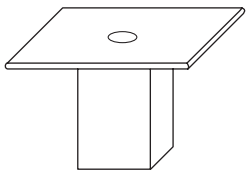

ME77A-IRH1	3520	3802	4224	42	42	29		142
ME77B-IRH1	3725	4023	4470	48	48	29		158
ME77C-IRH1	3965	4282	4758	54	54	29		178
ME77D-IRH1	4235	4574	5082	60	60	29		192

Veneer species must be noted on each line item

Wood column base, round electrical access grommet.

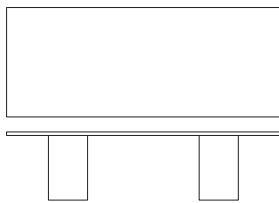

ME78E-I	5000	5400	6000	96	48	29		320
ME78F-I	5870	6340	7044	108	48	29		335
ME78G-I	6420	6934	7704	120	48	29		353

Veneer species must be noted on each line item

Wood column base.

Veneer species must be noted on each line item

**Veneer Grade 1**    **Veneer Grade 2**    **Veneer Grade 3**

Cherry                      Rift Oak                      Anigre  
 Maple                      Sapele  
 Ligno-Grain  
 Walnut

# HBF Mercer Conference Tables

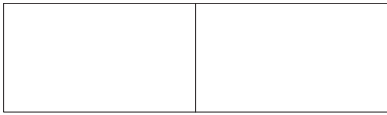
Style Number	List Price			Dimensions			Weight	
	Veneer 1	Veneer 2	Veneer 3	OW	OD	OH		DIA
<b>Wood Bases</b>								
	ME78H-I	8100	8748	9720	144	54	29	581
	ME78J-I	8930	9644	10716	168	54	29	622
	ME78K-I	10315	11140	12378	192	54	29	662
	ME78L-I	10865	11734	13038	216	60	29	743

Veneer species must be noted on each line item  
Two-piece top, wood column base.

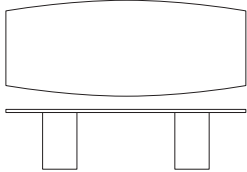
	ME80E-Y	6005	6485	7206	96	48	29	298
	ME80F-Y	6910	7463	8292	108	48	29	321
	ME80G-Y	7490	8089	8988	120	48	29	339

Veneer species must be noted on each line item  
Boat top, wood column bases.

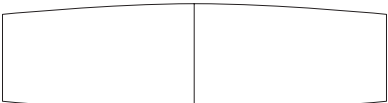
	ME80H-Y	8830	9536	10596	144	54	29	545
	ME80J-Y	9670	10444	11604	168	54	29	586
	ME80K-Y	11050	11934	13260	192	60	29	626
	ME80L-Y	11600	12528	13920	216	60	29	707

Veneer species must be noted on each line item  
Boat two-piece top, wood column bases.

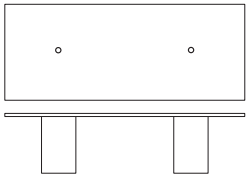
	ME78E-IRH2	6470	6988	7764	96	48	29	320
	ME78F-IRH2	7340	7927	8808	108	48	29	335
	ME78G-IRH2	7890	8521	9468	120	48	29	353

Veneer species must be noted on each line item  
Wood column bases, round electrical access grommets.

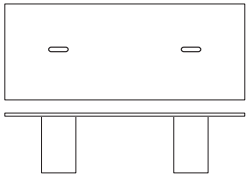
	ME78E-IOH2	6890	7441	8268	96	48	29	320
	ME78F-IOH2	7760	8381	9312	108	48	29	335
	ME78G-IOH2	8310	8975	9972	120	48	29	353

Veneer species must be noted on each line item  
Wood column bases, oval electrical access grommets.

**Veneer species must be noted on each line item**

Veneer Grade 1	Veneer Grade 2	Veneer Grade 3
Cherry	Rift Oak	Anigre
Maple	Sapele	
Ligno-Grain		
Walnut		



# HBF Mercer Conference Tables

Style Number	List Price			Dimensions			Weight	
	Veneer 1	Veneer 2	Veneer 3	OW	OD	OH		
<b>Wood Bases</b>								
	ME78H-IOH2	9990	10789	11988	144	54	29	581
	ME78J-IOH2	10820	11686	12984	168	54	29	622
	ME78K-IOH2	12205	13181	14646	192	60	29	662
	ME78L-IOH2	12755	13775	15306	216	60	29	743

Veneer species must be noted on each line item

Two-piece top, wood column bases, oval electrical access grommets.

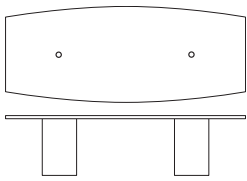
	ME80E-YRH2	7475	8073	8970	96	48	29	298
	ME80F-YRH2	8380	9050	10056	108	48	29	321
	ME80G-YRH2	8960	9677	10752	120	48	29	339

Veneer species must be noted on each line item

Boat top, wood column bases, round electrical access grommets.

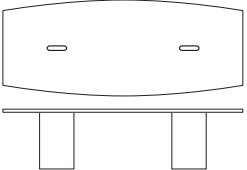
	ME80E-YOH2	7895	8527	9474	96	48	29	298
	ME80F-YOH2	8800	9504	10560	108	48	29	321
	ME80G-YOH2	9380	10130	11256	120	48	29	339

Veneer species must be noted on each line item

Boat top, wood column bases, oval electrical access grommets.

	ME80H-YOH2	10720	11578	12864	144	54	29	545
	ME80J-YOH2	11560	12485	13872	168	54	29	586
	ME80K-YOH2	12940	13975	15528	192	60	29	626
	ME80L-YOH2	13490	14569	16188	216	60	29	707

Veneer species must be noted on each line item

Boat two-piece top, wood column bases, oval electrical access grommets.

Veneer species must be noted on each line item

Veneer Grade 1	Veneer Grade 2	Veneer Grade 3
Cherry	Rift Oak	Anigre
Maple	Sapele	
Ligno-Grain		
Walnut		

# HBF Mercer Conference Table Specifications

---

## Tables with Metal Bases

---

**Veneer** Premium grade flat cut veneer tops. Edges are bordered with solids.

---

### Top Edge Detail

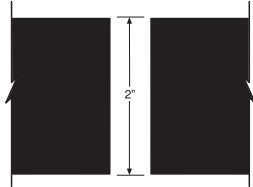

**Mercer**

---

**Worksurfaces** Mercer conference tables have a 2" (51mm) thick worksurface.

---

### Base Options



**Metal X-Base  
for Round Tables**

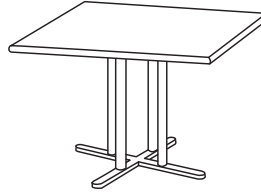

**Metal X-Base  
for Square Tables**

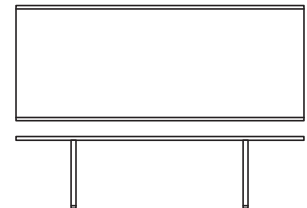

**Metal I-Bases  
for Rectangular Tables**

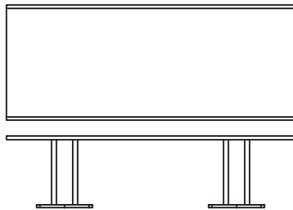

**Metal X-Bases  
for Rectangular Tables**

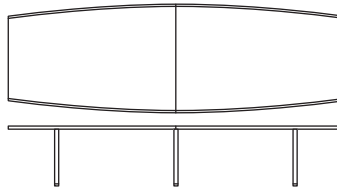

**Metal I-Bases  
for Boat Shape Tables**

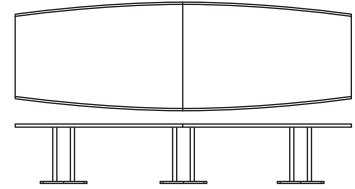

**Metal X-Bases  
for Boat Shape Tables**

---

### Metal Bases

Metal bases are available in an I-Base or an X-Base. These bases are standard in HBF Satin Pewter powder coat finish. Refer to individual styles to determine base shape available on particular conference tables. Metal bases for tables specifying power/data capabilities incorporate wire management channels.

---

# HBF Mercer Conference Table Specifications

---

## Tables with Metal Bases

---

### Round Metal Grommet Power Data Plate

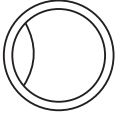

Mercer Conference Tables with metal bases are available with either a round or oval grommet and power/data access units. Bases for tables with power/data access incorporate wire management channels.

The removable round grommet is standard in HBF Satin Pewter powder coat finish and mounts flush with the top surface. The power/data unit provides two (2) 110 volt electrical outlets and two (2) Cat.5E data jacks. This unit uses a six foot soft cord with a grounded plug.



The hinged oval grommet is standard in HBF Satin Pewter powder coat finish and mounts flush with the top surface. The power/data unit provides four (4) 110 volt electrical outlets and six (6) Cat.5E data jacks. This unit uses a six foot soft cord with a grounded plug.

### Oval Metal Grommet Power Data Plate

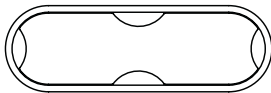

The electrical components provided within this group of furniture are engineered and manufactured in compliance with NEC regulation, however ***it is the responsibility of the specifier and contracted installer of the furniture to be aware of the local building and electrical restrictions.*** Electrical components meet both Chicago and New York electrical codes.

Additional voice/data inserts are available to replace the standard data jacks. These inserts can be ordered from Doug Mockett & Company ([www.mockett.com](http://www.mockett.com)) and installed as required by the end user's data specialist to accommodate specific requirements.

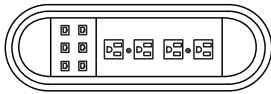

# HBF Mercer Conference Tables

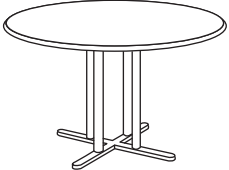
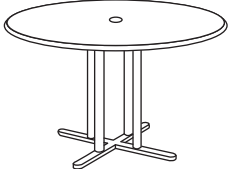
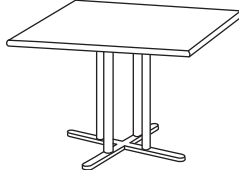
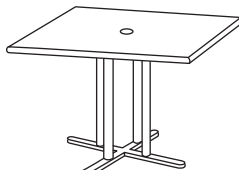
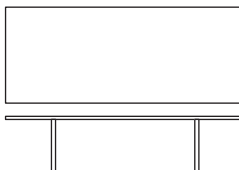
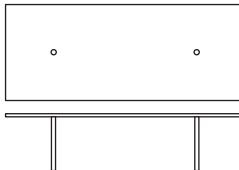
	Style Number	List Price			Dimensions			Weight	
		Veneer 1	Veneer 2	Veneer 3	OW	OD	OH		DIA
<b>Metal Bases</b>									
	ME74A-E	2405	2597	2886			29	42	125
	ME74B-E	2655	2867	3186			29	48	140
	ME74C-E	3070	3316	3684			29	54	155
	ME74D-E	3480	3758	4176			29	60	170
<b>Veneer species must be noted on each line item</b>									
Metal X-Base.									
	ME74A-ERS1	3140	3391	3768			29	42	125
	ME74B-ERS1	3390	3661	4068			29	48	140
	ME74C-ERS1	3805	4109	4566			29	54	155
	ME74D-ERS1	4215	4552	5058			29	60	170
<b>Veneer species must be noted on each line item</b>									
Metal X-Base, round electrical access grommet.									
	ME77A-E	2320	2506	2784	42	42	29		140
	ME77B-E	2570	2776	3084	48	48	29		155
	ME77C-E	2900	3132	3480	54	54	29		175
<b>Veneer species must be noted on each line item</b>									
Metal X-Base.									
	ME77A-ERS1	2900	3132	3480	42	42	29		145
	ME77B-ERS1	3150	3402	3780	48	48	29		160
	ME77C-ERS1	3480	3758	4176	54	54	29		180
<b>Veneer species must be noted on each line item</b>									
Metal X-Base, round electrical access grommet.									
	ME78C-S	3060	3305	3672	72	36	29		190
	ME78D-S	3515	3796	4218	84	42	29		220
	ME78E-S	4015	4336	4818	96	48	29		260
	ME78F-S	4760	5141	5712	108	48	29		280
	ME78G-S	5670	6124	6804	120	48	29		300
<b>Veneer species must be noted on each line item</b>									
Metal I-Bases.									
	ME78C-SRS2	4530	4892	5436	72	36	29		190
	ME78D-SRS2	4985	5384	5982	84	42	29		220
	ME78E-SRS2	5485	5924	6582	96	48	29		260
	ME78F-SRS2	6230	6728	7476	108	48	29		280
	ME78G-SRS2	7140	7711	8568	120	48	29		300
<b>Veneer species must be noted on each line item</b>									
Metal I-Bases, two round electrical access grommets.									
<b>Veneer species must be noted on each line item</b>									
<b>Veneer Grade 1</b>			<b>Veneer Grade 2</b>			<b>Veneer Grade 3</b>			
Cherry			Rift Oak			Anigre			
Maple			Sapele						
Ligno-Grain									
Walnut									

# HBF Mercer Conference Tables

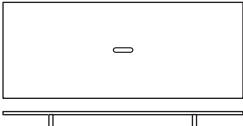
Style Number	List Price			Dimensions			Weight	
	Veneer 1	Veneer 2	Veneer 3	OW	OD	OH		
	ME78C-SOS1	4005	4325	4806	72	36	29	195
	ME78D-SOS1	4460	4817	5352	84	42	29	225
	ME78E-SOS1	4960	5357	5952	96	48	29	265
	ME78F-SOS1	5705	6161	6846	108	48	29	285
	ME78G-SOS1	6615	7144	7398	120	48	29	305

Veneer species must be noted on each line item

Metal I-Bases, oval electrical access grommet.

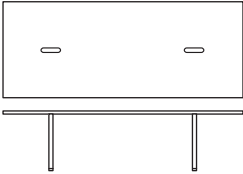
	ME78G-SOS2	7560	8165	9072	120	48	29	310
---	------------	------	------	------	-----	----	----	-----

Veneer species must be noted on each line item

Metal I-Bases, two oval electrical access grommets.

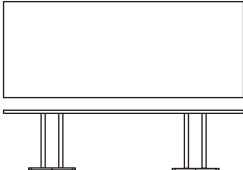
	ME78C-E	3900	4212	4680	72	36	29	230
	ME78D-E	4355	4703	5226	84	42	29	260
	ME78E-E	4855	5243	5826	96	48	29	295
	ME78F-E	5600	6048	6720	108	48	29	320
	ME78G-E	6510	7031	7812	120	48	29	335

Veneer species must be noted on each line item

Metal X-Bases.

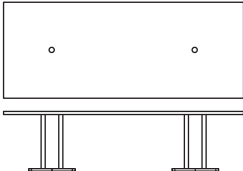
	ME78C-ERS2	5370	5800	6444	72	36	29	230
	ME78D-ERS2	5825	6291	6990	84	42	29	260
	ME78E-ERS2	6325	6831	7590	96	48	29	295
	ME78F-ERS2	7070	7636	8484	108	48	29	320
	ME78G-ERS2	7980	8618	9576	120	48	29	335

Veneer species must be noted on each line item

Metal X-Bases, two round electrical access grommets.

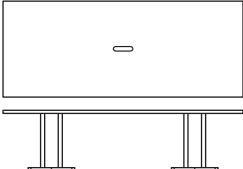
	ME78C-EOS1	4845	5233	5814	72	36	29	195
	ME78D-EOS1	5300	5724	6360	84	42	29	225
	ME78E-EOS1	5800	6264	6960	96	48	29	265
	ME78F-EOS1	6545	7069	7854	108	48	29	285
	ME78G-EOS1	7455	8051	8946	120	48	29	305

Veneer species must be noted on each line item

Metal X-Bases, oval electrical access grommet.

Veneer species must be noted on each line item

Veneer Grade 1	Veneer Grade 2	Veneer Grade 3
Cherry	Rift Oak	Anigre
Maple	Sapele	
Ligno-Grain		
Walnut		

# HBF Mercer Conference Tables

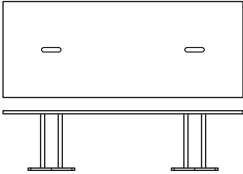
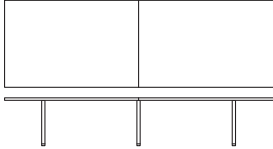
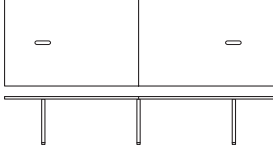
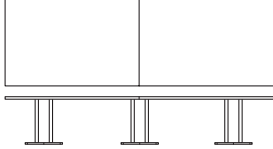
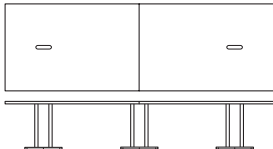
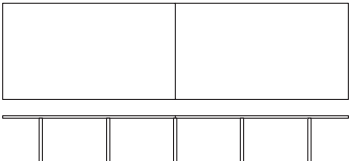
Style Number	List Price			Dimensions			DIA	Weight															
	Veneer 1	Veneer 2	Veneer 3	OW	OD	OH																	
<b>Metal Bases</b>																							
	<b>ME78G-EOS2</b>	<b>8400</b>	<b>9072</b>	<b>10080</b>	120	48	29	310															
	<b>Veneer species must be noted on each line item</b> Metal X-Bases, two oval electrical access grommets.																						
	<b>ME78H-S</b>	<b>7745</b>	<b>8365</b>	<b>9294</b>	144	54	29	420															
	<b>ME78J-S</b>	<b>8490</b>	<b>9169</b>	<b>10188</b>	168	54	29	460															
<b>Veneer species must be noted on each line item</b> Two-piece top, metal I-Bases.																							
	<b>ME78H-SOS2</b>	<b>9635</b>	<b>10406</b>	<b>11562</b>	144	54	29	430															
	<b>ME78J-SOS2</b>	<b>10380</b>	<b>11210</b>	<b>12456</b>	168	54	29	470															
<b>Veneer species must be noted on each line item</b> Two-piece top, metal I-Bases, two oval electrical access grommets.																							
	<b>ME78H-E</b>	<b>9005</b>	<b>9725</b>	<b>10806</b>	144	54	29	475															
	<b>ME78J-E</b>	<b>9750</b>	<b>10530</b>	<b>11700</b>	168	54	29	520															
<b>Veneer species must be noted on each line item</b> Two-piece top, metal X-Bases.																							
	<b>ME78H-EOS2</b>	<b>10895</b>	<b>11767</b>	<b>13074</b>	144	54	29	485															
	<b>ME78J-EOS2</b>	<b>11640</b>	<b>12571</b>	<b>13968</b>	168	54	29	530															
<b>Veneer species must be noted on each line item</b> Two-piece top, metal X-Bases, two oval electrical access grommets.																							
	<b>ME78K-S</b>	<b>9320</b>	<b>10066</b>	<b>11184</b>	192	54	29	585															
	<b>ME78L-S</b>	<b>10740</b>	<b>11599</b>	<b>12888</b>	216	60	29	670															
<b>Veneer species must be noted on each line item</b> Two-piece top, metal I-Bases.																							
<b>Veneer species must be noted on each line item</b> <table border="0"> <tr> <td><b><u>Veneer Grade 1</u></b></td> <td><b><u>Veneer Grade 2</u></b></td> <td><b><u>Veneer Grade 3</u></b></td> </tr> <tr> <td>Cherry</td> <td>Rift Oak</td> <td>Anigre</td> </tr> <tr> <td>Maple</td> <td>Sapele</td> <td></td> </tr> <tr> <td>Ligno-Grain</td> <td></td> <td></td> </tr> <tr> <td>Walnut</td> <td></td> <td></td> </tr> </table>									<b><u>Veneer Grade 1</u></b>	<b><u>Veneer Grade 2</u></b>	<b><u>Veneer Grade 3</u></b>	Cherry	Rift Oak	Anigre	Maple	Sapele		Ligno-Grain			Walnut		
<b><u>Veneer Grade 1</u></b>	<b><u>Veneer Grade 2</u></b>	<b><u>Veneer Grade 3</u></b>																					
Cherry	Rift Oak	Anigre																					
Maple	Sapele																						
Ligno-Grain																							
Walnut																							

# HBF Mercer Conference Tables

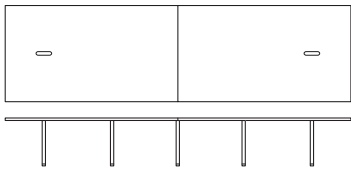
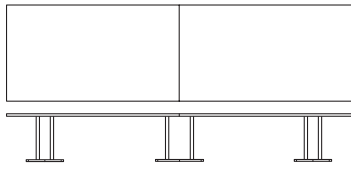
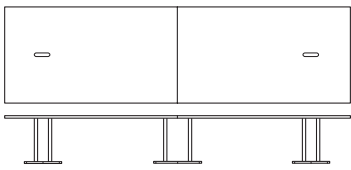
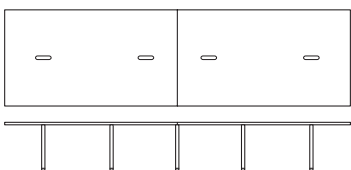
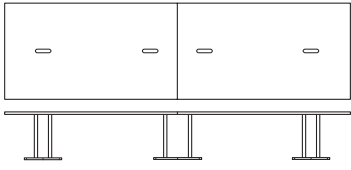
Style Number	List Price			Dimensions			DIA	Weight															
	Veneer 1	Veneer 2	Veneer 3	OW	OD	OH																	
<b>Metal Bases</b>																							
	ME78K-SOS2	11210	12107	13452	192	54	29	595															
	ME78L-SOS2	12630	13640	15156	216	60	29	680															
<b>Veneer species must be noted on each line item</b> Two-piece top, metal I-Bases, two oval electrical access grommets.																							
	ME78K-E	9740	10519	11688	192	54	29	560															
	ME78L-E	11160	12053	13392	216	60	29	640															
<b>Veneer species must be noted on each line item</b> Two-piece top, metal X-Bases.																							
	ME78K-EOS2	11630	12560	13956	192	54	29	570															
	ME78L-EOS2	13050	14094	15660	216	60	29	650															
<b>Veneer species must be noted on each line item</b> Two-piece top, metal X-Bases, two oval electrical access grommets.																							
	ME78K-SOS4	13100	14148	15720	192	54	29	605															
	ME78L-SOS4	14520	15682	17424	216	60	29	690															
<b>Veneer species must be noted on each line item</b> Two-piece top, metal I-Bases, four oval electrical access grommets.																							
	ME78K-EOS4	13520	14602	16224	192	54	29	580															
	ME78L-EOS4	14940	16135	17928	216	60	29	660															
<b>Veneer species must be noted on each line item</b> Two-piece top, metal X-Bases, four oval electrical access grommets.																							
<b>Veneer species must be noted on each line item</b> <table border="0"> <tr> <td><b><u>Veneer Grade 1</u></b></td> <td><b><u>Veneer Grade 2</u></b></td> <td><b><u>Veneer Grade 3</u></b></td> </tr> <tr> <td>Cherry</td> <td>Rift Oak</td> <td>Anigre</td> </tr> <tr> <td>Maple</td> <td>Sapele</td> <td></td> </tr> <tr> <td>Ligno-Grain</td> <td></td> <td></td> </tr> <tr> <td>Walnut</td> <td></td> <td></td> </tr> </table>									<b><u>Veneer Grade 1</u></b>	<b><u>Veneer Grade 2</u></b>	<b><u>Veneer Grade 3</u></b>	Cherry	Rift Oak	Anigre	Maple	Sapele		Ligno-Grain			Walnut		
<b><u>Veneer Grade 1</u></b>	<b><u>Veneer Grade 2</u></b>	<b><u>Veneer Grade 3</u></b>																					
Cherry	Rift Oak	Anigre																					
Maple	Sapele																						
Ligno-Grain																							
Walnut																							

# HBF Mercer Conference Tables

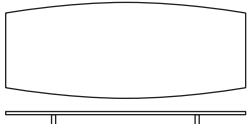
Style Number	List Price			Dimensions			Weight	
	Veneer 1	Veneer 2	Veneer 3	OW	OD	OH		
<b>Metal Bases</b>								
	ME80C-S	3640	3931	4368	72	36	29	190
	ME80D-S	4095	4423	4914	84	42	29	220
	ME80E-S	4595	4963	5514	96	48	29	260
	ME80F-S	5340	5767	6408	108	48	29	280
	ME80G-S	5920	6394	7104	120	48	29	300

Veneer species must be noted on each line item

Boat top, metal I-Bases.

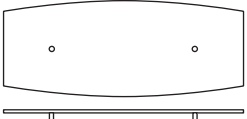
	ME80C-SRS2	5110	5519	6132	72	36	29	200
	ME80D-SRS2	5565	6010	6678	84	42	29	230
	ME80E-SRS2	6065	6550	7278	96	48	29	270
	ME80F-SRS2	6810	7355	8172	108	48	29	290
	ME80G-SRS2	7390	7981	8868	120	48	29	310

Veneer species must be noted on each line item

Boat top, metal I-Bases, two round electrical access grommets.

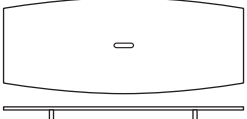
	ME80C-SOS1	4585	4952	5502	72	36	29	200
	ME80D-SOS1	5040	5443	6048	84	42	29	230
	ME80E-SOS1	5540	5983	6648	96	48	29	270
	ME80F-SOS1	6285	6788	7542	108	48	29	290
	ME80G-SOS1	6865	7414	8238	120	48	29	310

Veneer species must be noted on each line item

Boat top, metal I-Bases, one oval electrical access grommet.

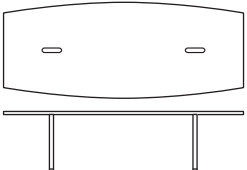
	ME80G-SOS2	7810	8435	9372	120	48	29	310
---	------------	------	------	------	-----	----	----	-----

Veneer species must be noted on each line item

Boat top, metal I-Bases, two oval electrical access grommets.

	ME80C-E	4480	4838	5376	72	36	29	230
	ME80D-E	4935	5330	5922	84	42	29	260
	ME80E-E	5435	5870	6522	96	48	29	295
	ME80F-E	6180	6674	7416	108	48	29	320
	ME80G-E	6760	7301	8112	120	48	29	335

Veneer species must be noted on each line item

Boat top, metal X-Bases.

Veneer species must be noted on each line item

Veneer Grade 1	Veneer Grade 2	Veneer Grade 3
Cherry	Rift Oak	Anigre
Maple	Sapele	
Ligno-Grain		
Walnut		

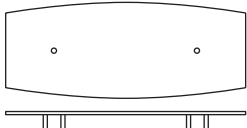

# HBF Mercer Conference Tables

Style Number	List Price			Dimensions			Weight	
	Veneer 1	Veneer 2	Veneer 3	OW	OD	OH		
	ME80C-ERS2	5950	6426	7140	72	36	29	190
	ME80D-ERS2	6405	6917	7686	84	42	29	220
	ME80E-ERS2	6905	7457	8286	96	48	29	260
	ME80F-ERS2	7650	8262	9180	108	48	29	280
	ME80G-ERS2	8230	8888	9876	120	48	29	300

Veneer species must be noted on each line item

Boat top, metal X-Bases, two round electrical access grommets.

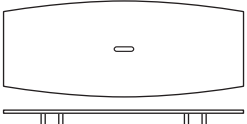
	ME80C-EOS1	5425	5859	6510	72	36	29	235
	ME80D-EOS1	5880	6350	7056	84	42	29	265
	ME80E-EOS1	6380	6890	7656	96	48	29	300
	ME80F-EOS1	7125	7695	8550	108	48	29	325
	ME80G-EOS1	7705	8321	9246	120	48	29	340

Veneer species must be noted on each line item

Boat top, metal X-Bases, one oval electrical access grommet.

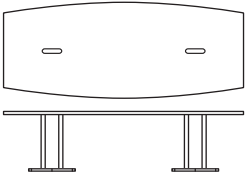
	ME80G-EOS2	8650	9342	10380	120	48	29	345
--	------------	------	------	-------	-----	----	----	-----

Veneer species must be noted on each line item

Boat top, metal X-Bases, two oval electrical access grommets.

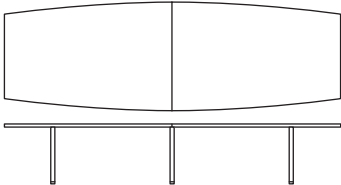
	ME80H-S	7995	8635	9594	144	54	29	420
	ME80J-S	8740	9439	10488	168	54	29	460

Veneer species must be noted on each line item

Boat two-piece top, metal I-Bases.

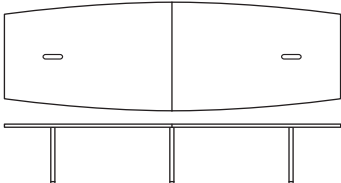
	ME80H-SOS2	9885	10676	11862	144	54	29	430
	ME80J-SOS2	10630	11480	12756	168	54	29	470

Veneer species must be noted on each line item

Boat two-piece top, metal I-Bases, two oval electrical access grommets.

Veneer species must be noted on each line item

Veneer Grade 1	Veneer Grade 2	Veneer Grade 3
Cherry	Rift Oak	Anigre
Maple	Sapele	
Ligno-Grain		
Walnut		

# HBF Mercer Conference Tables

Style Number	List Price			Dimensions			DIA	Weight
	Veneer 1	Veneer 2	Veneer 3	OW	OD	OH		

## Metal Bases

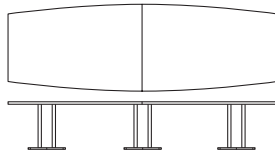

<b>ME80H-E</b>	<b>9255</b>	<b>9995</b>	<b>11106</b>	144	54	29		475
<b>ME80J-E</b>	<b>10000</b>	<b>10800</b>	<b>12000</b>	168	54	29		520

**Veneer species must be noted on each line item**

Boat two-piece top, metal X-Bases.

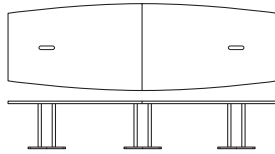

<b>ME80H-EOS2</b>	<b>11145</b>	<b>12037</b>	<b>13374</b>	144	54	29		485
<b>ME80J-EOS2</b>	<b>11890</b>	<b>12841</b>	<b>14268</b>	168	54	29		530

**Veneer species must be noted on each line item**

Boat two-piece top, metal X-Bases, two oval electrical access grommets.

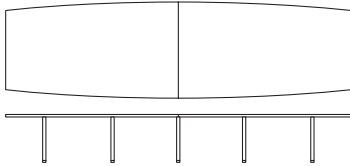

<b>ME80K-S</b>	<b>9570</b>	<b>10366</b>	<b>11484</b>	144	60	29		485
<b>ME80L-S</b>	<b>10990</b>	<b>11869</b>	<b>13188</b>	168	60	29		530

**Veneer species must be noted on each line item**

Boat two-piece top, metal I-Bases.

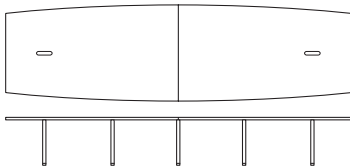

<b>ME80K-SOS2</b>	<b>11460</b>	<b>12377</b>	<b>13752</b>	192	60	29		570
<b>ME80L-SOS2</b>	<b>12880</b>	<b>13910</b>	<b>15456</b>	216	60	29		650

**Veneer species must be noted on each line item**

Boat two-piece top, metal I-Bases, two oval electrical access grommets.

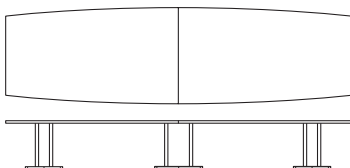

<b>ME80K-E</b>	<b>9990</b>	<b>10789</b>	<b>11988</b>	192	60	29		585
<b>ME80L-E</b>	<b>11410</b>	<b>12323</b>	<b>13692</b>	216	60	29		670

**Veneer species must be noted on each line item**

Boat two-piece top, metal X-Bases.

**Veneer species must be noted on each line item**

<u>Veneer Grade 1</u>	<u>Veneer Grade 2</u>	<u>Veneer Grade 3</u>
Cherry	Rift Oak	Anigre
Maple	Sapele	
Ligno-Grain		
Walnut		

# HBF Mercer Conference Tables

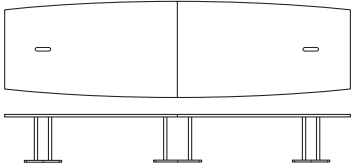
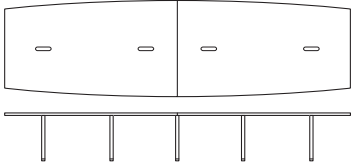
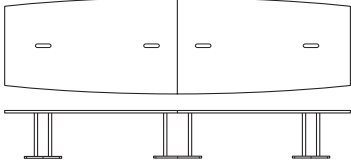
Style Number	List Price			Dimensions			DIA	Weight
	Veneer 1	Veneer 2	Veneer 3	OW	OD	OH		
<b>Metal Bases</b>								
	<b>ME80K-EOS2</b>	<b>11880</b>	<b>12830</b>	<b>14256</b>	192	54	29	595
	<b>ME80L-EOS2</b>	<b>13300</b>	<b>14364</b>	<b>15960</b>	216	60	29	680
<b>Veneer species must be noted on each line item</b>								
Boat two-piece top, metal X-Bases, two oval electrical access grommets.								
	<b>ME80K-SOS4</b>	<b>13350</b>	<b>14418</b>	<b>16020</b>	192	60	29	580
	<b>ME80L-SOS4</b>	<b>14770</b>	<b>15952</b>	<b>17724</b>	216	60	29	660
<b>Veneer species must be noted on each line item</b>								
Boat two-piece top, metal I-Bases, four oval electrical access grommets.								
	<b>ME80K-EOS4</b>	<b>13370</b>	<b>14872</b>	<b>16524</b>	192	60	29	580
	<b>ME80L-EOS4</b>	<b>15190</b>	<b>16405</b>	<b>18228</b>	216	60	29	660
<b>Veneer species must be noted on each line item</b>								
Boat two-piece top, metal X-Bases, four oval electrical access grommets.								

**Veneer species must be noted on each line item**

<u>Veneer Grade 1</u>	<u>Veneer Grade 2</u>	<u>Veneer Grade 3</u>
Cherry	Rift Oak	Anigre
Maple	Sapele	
Ligno-Grain		
Walnut		

# HBF Mercer Conference Cabinetry

Style Number	List Price			Dimensions				Weight
	Veneer 1	Veneer 2	Veneer 3	OW	OD	OH	DIA	

## Audio Visual Cart

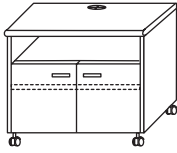

<b>ME53A</b>	<b>2700</b>	<b>2916</b>	<b>3240</b>	36	24	29	192
--------------	-------------	-------------	-------------	----	----	----	-----

**Veneer species must be noted on each line item**

Cart with open shelf. Lower storage compartment has one adjustable shelf, back is fully finished, casters. Power/communication strip mounted in back of cabinet, includes four electrical outlets and one cable line. Optional black power/data unit can be supplied to mount on any surface of cart. Softwired unit provides two 110 volt electrical outlets and two data jacks. Specify **AC96NB**, add **\$295 List**.

## Audio Visual Storage Cabinet, Top without Profile Edge Detail

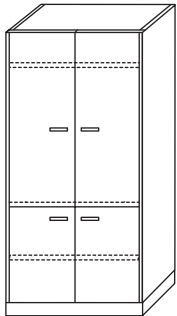

<b>ME53D</b>	<b>6430</b>	<b>6944</b>	<b>7716</b>	38	30	71 1/2	271
--------------	-------------	-------------	-------------	----	----	--------	-----

**Veneer species must be noted on each line item**

Standard black unfinished back. Power/communication strip mounted in back of cabinet and includes four electrical outlets and one cable line. Upper storage area accessed through pocket doors. The extendable turntable supports up to 200 lbs., interior dimensions of upper storage area are 31" OW x 29" OD x 40 1/4 OH.

## Audio Visual Storage Cabinet, Top with Profile Edge Detail

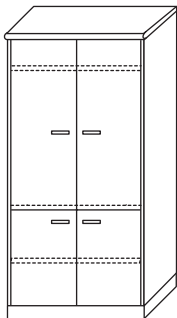

<b>ME53D-C</b>	<b>6830</b>	<b>7376</b>	<b>8196</b>	38	30	73 ME	286
----------------	-------------	-------------	-------------	----	----	-------	-----

**Veneer species must be noted on each line item**

Standard black unfinished back. Power/communication strip mounted in back of cabinet and includes four electrical outlets and one cable line. Upper storage area accessed through pocket doors. The extendable turntable supports up to 200 lbs., interior dimensions of upper storage area are 31" OW x 29" OD x 40 1/4 OH.

## Wall Mounted Presentation Cabinet, Top without Profile Edge Detail

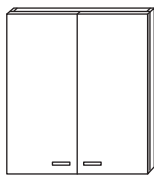

<b>ME37M</b>	<b>2090</b>	<b>2257</b>	<b>2508</b>	48	7	48	210
--------------	-------------	-------------	-------------	----	---	----	-----

<b>ME37N</b>	<b>2715</b>	<b>2932</b>	<b>3258</b>	60	7	48	210
--------------	-------------	-------------	-------------	----	---	----	-----

**Veneer species must be noted on each line item**

Presentation cabinet, white marker board (markers and eraser included), pull down projection screen, wood pencil/marker tray. Fabric covered tackboards on inside of each door, fabric requirement is 3 yards per unit. List price includes application of COM, COM must be acrylic backed prior to shipment to HBF. For specification of any HBF Textiles product, add 5% List.

**Veneer species must be noted on each line item**

<u>Veneer Grade 1</u>	<u>Veneer Grade 2</u>	<u>Veneer Grade 3</u>
Cherry	Rift Oak	Anigre
Maple	Sapele	
Ligno-Grain		
Walnut		

# HBF Mercer Conference Cabinetry

Style Number	List Price			Dimensions				Weight
	Veneer 1	Veneer 2	Veneer 3	OW	OD	OH	DIA	

## Wall Mounted Presentation Cabinet, Top with Profile Edge Detail

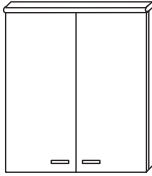

ME37M-C	2390	2581	2868	48	7	49 1/2	210
ME37N-C	3015	3256	3618	60	7	49 1/2	210

Veneer species must be noted on each line item

Presentation cabinet, white marker board (markers and eraser included), pull down projection screen, wood pencil/marker tray. Fabric covered tackboards on inside of each door, fabric requirement is 3 yards per unit. List price includes application of COM, COM must be acrylic backed prior to shipment to HBF. For specification of any HBF Textiles product, add 5% List.

## Plasma Screen Enclosure, Top without Profile Edge Detail

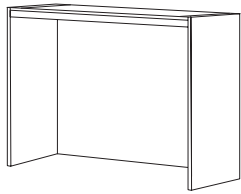

ME54M	1895	2047	2274	48	15	42 1/4	145
ME54A	2525	2727	3030	72	15	42 1/4	165
ME54B	2985	3224	3582	84	15	42 1/4	185

Veneer species must be noted on each line item

## Plasma Screen Enclosure, Top with Profile Edge Detail

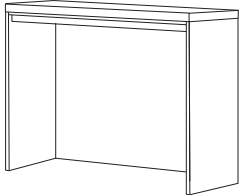

ME54M-C	2195	2371	2634	48	15	43 5/8	150
ME54A-C	2825	3051	3390	72	15	43 5/8	170
ME54B-C	3285	3548	3942	84	15	43 5/8	190

Veneer species must be noted on each line item

## Plasma Screen Enclosure, Top without Profile Edge Detail (Double High)

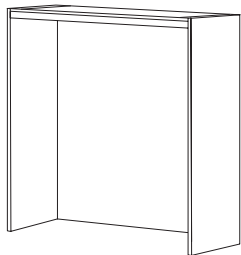

ME54M2	2595	2803	3114	48	15	56	167
ME54A2	3225	3483	3870	72	15	56	187
ME54B2	3685	3980	4422	84	15	56	207

Veneer species must be noted on each line item

## Plasma Screen Enclosure, Top with Profile Edge Detail (Double High)

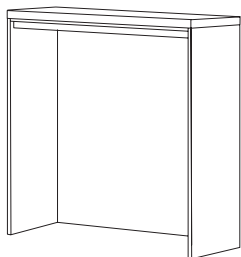

ME54M2-C	2895	3127	3474	48	15	57 3/8	172
ME54A2-C	3525	3807	4230	72	15	57 3/8	192
ME54B2-C	3985	4304	4782	84	15	57 3/8	212

Veneer species must be noted on each line item

Veneer species must be noted on each line item

Veneer Grade 1	Veneer Grade 2	Veneer Grade 3
Cherry	Rift Oak	Anigre
Maple	Sapele	
Ligno-Grain		
Walnut		

# HBF Mercer Conference Cabinetry

Style Number	List Price			Dimensions			DIA	Weight
	Veneer 1	Veneer 2	Veneer 3	OW	OD	OH		
<b>Lectern</b>								
<b>ME53P</b>	<b>4195</b>	<b>4531</b>	<b>5034</b>	31 1/4	27 1/2	48		105

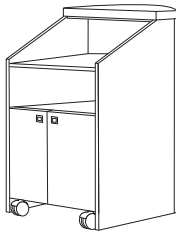

Veneer species must be noted on each line item

**Veneer species must be noted on each line item**

<u>Veneer Grade 1</u>	<u>Veneer Grade 2</u>	<u>Veneer Grade 3</u>
Cherry	Rift Oak	Anigre
Maple	Sapele	
Ligno-Grain		
Walnut		