

F A I R M O N T
C A S E G O O D S
C O N F E R E N C E
L I S T P R I C E S E F F E C T I V E
M A R C H 1 , 2 0 0 8

F A I R M O N T



2 0 0 8

HBF 2008 Price List Contents

Effective Date: March 1, 2008

Mailing Address:
HBF/HBF Textiles
PO Box 8
Hickory, NC 28603-0008

Shipping Address:
HBF/HBF Textiles
900-12th Street Drive NW
Hickory, NC 28601-4763

Phone: 828.328.2064
Fax: 828.485.2690
info: info@hbf.com
www.hbf.com
www.hbftextiles.com

CONTENTS

	PAGE		PAGE
CASEGOOD SPECIFICATIONS		CONFERENCE PRODUCTS	
Access Panels, Removable	.3	Conference Table Specifications - Metal Bases	
Base Details	.3	Base Options	.97
Edge Details	.2	Edge Details	.97
Doors	.3	Electrical Access Grommets	.98
Drawers	.3	Power/Data Plates	.98
Finishes	.2	Veneer	.97
Grommets	.4	Worksurfaces	.97
Hardware	.3	Conference Tables - Metal Bases	.99
Levelers	.3	Conference Table Specifications - Wood Bases	
Locks	.3	Base Options	.92
Modesty Panels	.3	Base Placement	.93
Pedestals	.3	Edge Details	.92
Suspension	.3	Electrical Access Grommets	.92, 93
Veneer	.2	Power/Data Plates	.92, 93
Worksurfaces	.2	Veneer	.92
CASEGOODS		Worksurfaces	.92
Bookcases, Double High	.85	Conference Tables - Wood Bases	.94
Bookcases, Single High	.84	Conference Cabinetry	
Bridges	.35	Audio/Visual Cart, Mobile	.107
Casegood Accessories		Audio/Visual Vertical Storage Cabinet	.107
Pedestal Shelves	.91	Lectern	.108
Pedestal Dividers	.91	Plasma Screen Enclosure	.108
Stack Shelves	.91	Wall Mounted Presentation Cabinet	.107
Worksurface Shelves	.91		
Corner Units	.35		
Credenzas	.20		
Credenza Storage Towers	.41		
Desk Extensions	.37		
Desks	.5		
File Pedestal, Mobile	.41		
Reception Desks	.87		
Lateral Files	.86		
Overhead Cabinets, Double High	.48		
Overhead Cabinets, Single High	.44		
Returns	.31		
Table Desks	.19		
Vertical Storage, Double High	.80		
Vertical Storage, Single High	.76		
Wardrobe Unit	.77		

HBF Fairmont Casegood Specifications

All HBF casegood orders must be accompanied by suite layout drawings.
 Drawings are needed to confirm proper unit configuration.
 If drawings are not included, orders may be delayed to confirm specifications.

Profile Edge Details



Worksurfaces

Fairmont has a 1 3/8" (35mm) thick worksurface and premium grade veneer top faces, edges are bordered with veneer solids.

Veneer

The following slip matched, plain sliced veneers are available with the finish options as shown below. Pricing for these veneers are shown by veneer grade.

Anigre: Color and grain variations are typical characteristics of anigre veneer. Color may range from light yellow to pale brown, sometimes with a pink tint. The grain pattern of anigre will also vary in frequency and size; grain pattern changes should be expected within a given product or suite of furniture.

Veneer Grade 1

Cherry
 Maple
 Ligno-Grain
 Walnut

Veneer Grade 2

Rift Oak
 Sapele

Veneer Grade 3

Anigre

Finish Availability Chart

	Cherry	Veneer Grade 1 Maple	Ligno-Grain	Walnut	Veneer Grade 2 Rift Oak	Sapele	Veneer Grade 3 Anigre
01 Centennial	•		•				
02 Espresso	•		•				
03 Imperial	•		•				
05 Tuscan	•		•				
06 Amber	•		•			•	
07 Chestnut	•		•				
09 Onyx	•		•				
10 Honey	•		•				
11 Amazon	•		•				
12 Wheat		•	•				
16 Caramel		•	•		•		
17 Scone						•	
18 Biscotti		M*					
19 Butterscotch							•
20 Hazelnut		M*					
21 Chai							•
22 Cider		M*					
23 Mocha					•		
24 Chocolat		M*					
25 Cocoa				•			
26 Latte		M*					
27 Honeycomb				•			
28 Nectar		M*					
29 Nutmeg				•			
30 Toffee		M*					

M* (maple): These finishes are available only on maple seating and occasional table products and allow the specifier to create a finish that is complementary to non-maple veneers available on conference and casegood products. HBF's maple seating and occasional table products can therefore be specified with HBF conference and casegoods constructed with the available non-maple veneers and create an office environment with complementary wood tones. These finishes are not available on conference or casegood products.

18 Biscotti on maple complements 17 Scone on sapele
 20 Hazelnut on maple complements 19 Butterscotch on anigre
 22 Cider on maple complements 21 Chai on anigre
 24 Chocolat on maple complements 23 Mocha on rift oak
 26 Latte on maple complements 25 Cocoa on walnut
 28 Nectar on maple complements 27 Honeycomb on walnut
 30 Toffee on maple complements 29 Nutmeg on walnut

All conference and casegood products are standard with a 30° sheen.

An upcharge of **10% Net** per unit for conference and casegood products, with a minimum upcharge of **\$375 Net** per order will apply for any custom wood finish.

HBF Fairmont Casegood Specifications

Pedestals	Three depths (24", 30" and 36")
Doors	Three (3) ply veneer mounted with universal adjustment concealed hinges.
Levelers	All floor casegoods have adjustable levelers.
Modesty Panels	Desk modesty panels are available as finished, fixed panels either recessed 4" or flushed. Credenza, return and bridge modesty panels are available as finished, fixed panels or as recessed, unfinished back removable access panels.
Drawers	<p>Box and file drawers are 1/2" wood, doweled to form a four (4) sided rectangle with separate drawer front.</p> <p>Drawer bottoms are 1/4" thick and fitted in a dado groove so it is captured on four sides.</p> <p>Drawer faces are mechanically attached to allow for easy alignment.</p> <p>Each desk equipped with a box/box/file pedestal will include one maple divider and one maple pencil tray.</p> <p>Center drawers are optional and include a cherry or maple pencil and paper clip tray, see HBF Casegood Accessories.</p> <p>Center drawers are standard on all Fairmont table desks.</p>
Suspension	<p>All box drawers are standard with telescopic, full extension, ball-bearing slides.</p> <p>All file drawers are standard with fully progressive, full extension, ball-bearing slides.</p>
Base Details	Fairmont incorporates a scored base detail on the user and guest sides of the pedestals.
Removable Access Panels	<p>Fairmont credenzas or returns without a finished back can be specified with removable access panels in the kneespace. This panel can be easily removed to allow for complete wall access. When installed, the top of the access panel will be 3 1/4" from the underside of the worksurface to allow for wire or cable egress. The back of this panel and the back of pedestals are unfinished.</p> <p>Fairmont credenzas or returns specified with a finished back will be constructed with a fully finished, fixed modesty panel.</p>
Pull Hardware Options	Fairmont products are standard with the Gaston, Johnston or Chatham pull in a satin nickel finish. These products may also be specified with any of the pulls from HBF's Ashton, Courant, Legacy or Mercer product lines. Each order must specify pull and finish before order entry can proceed.

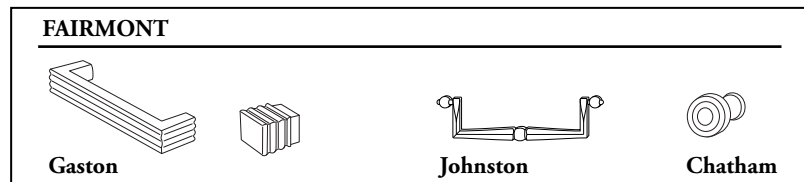

Locks All pedestals are standard with face locks. All credenza storage towers, vertical storage cabinets, overhead cabinets and bookcases with doors are available with optional face locks. **Add \$95 List** per lock for factory installation. (Locks standard on vertical cabinet file drawers)

Each individual unit (i.e. desk, credenza, overhead storage unit, etc.) will be keyed alike. Lock finish will match pull finish unless specified otherwise. If complete offices are required to be keyed alike, this designation must appear on each order. Units will be shipped with the lock barrels and locking mechanisms in place. A separate package will contain the appropriately numbered cylinders for field installations. If no specific lock instructions accompany the order, random keying between complete units will be installed.

HBF Fairmont Casegood Specifications

Grommets

Grommets are optional on all Fairmont desks, credenzas, returns, bridges, table desks, corner units and desk extensions. **Add \$95 List** for each factory installed grommet. Field installed circular grommets are available, **add \$40 List**. Finishes available are satin nickel, matte black powder coat and polished brass and will match specified finish for the pull hardware, unless otherwise noted. The 2" circular grommet is used on all desks and desk extensions. The 3" circular grommet is used on all credenzas, returns, bridges, and corner units.



For added convenience, the drawings below should be used to define the placement of each optional grommet location. Please attach a copy to the order.

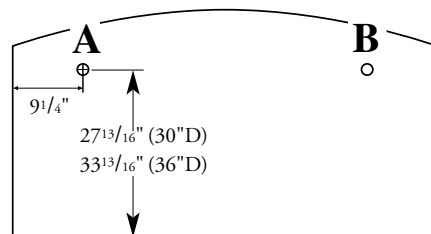

Desk- Bow Front Top

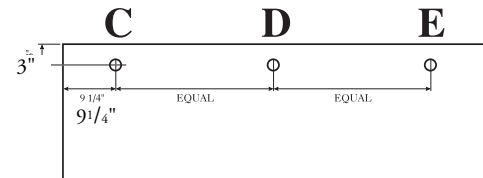

Credenza, Return, Bridge

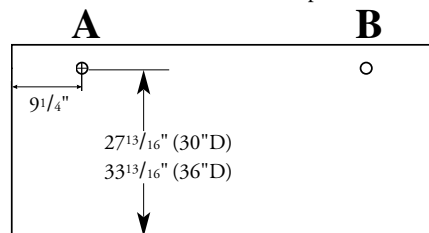

Desk - Rectangular Top

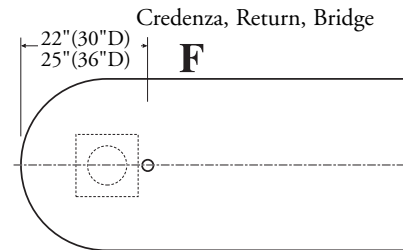

All Desk Extensions

If standard grommet placement locations do not provide suitable accessibility, a formal drawing of specified grommet location showing exact dimensions must accompany the order. No order specifying non-standard grommet placement will be entered until these drawings are received and approved by HBF.

Mobile Audio/Visual Cart Electrical Access

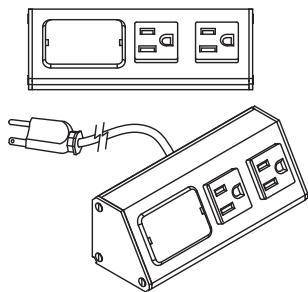

The Fairmont mobile audio/visual cart may be specified with a power/data unit that can be mounted to any surface on the cart. The unit is standard in a black finish and will be supplied for the end user to mount as needed to meet their specific requirements. Specify **AC96NB**, add **\$295 List**.

This power/data unit provides two 110 volt electrical outlets and two data jacks. The unit uses a soft cord with grounded plug.

The electrical components provided within this group of furniture are engineered and manufactured in compliance with NEC regulation, **however it is the responsibility of the specifier and contracted installer of the furniture to be aware of the local building and electrical restrictions.** Electrical components meet both Chicago and New York electrical codes.

HBF Fairmont Casegoods - Desks

Style Number	List Price			Dimensions			Weight
	Veneer 1	Veneer 2	Veneer 3	OW	OD	OH	

Rectangular Double Pedestal Desk - Recessed Modesty Panel

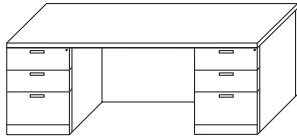

FA01A-AHA	4826	5212	5791	66	30	29	442
FA01C-AHA	4908	5301	5890	66	36	29	461
FA01D-AHA	4908	5301	5890	72	30	29	447
FA01F-AHA	4990	5390	5988	72	36	29	476
FA01G-AHA	5330	5757	6396	78	36	29	499

Veneer species must be noted on each line item

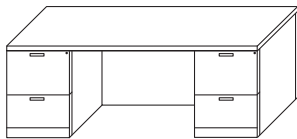

FA01A-BHB	4826	5212	5791	66	30	29	442
FA01C-BHB	4908	5301	5890	66	36	29	461
FA01D-BHB	4908	5301	5890	72	30	29	447
FA01F-BHB	4990	5390	5988	72	36	29	476
FA01G-BHB	5330	5757	6396	78	36	29	499

Veneer species must be noted on each line item

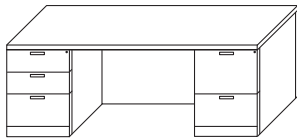

FA01A-AHB	4826	5212	5791	66	30	29	442
FA01C-AHB	4908	5301	5890	66	36	29	461
FA01D-AHB	4908	5301	5890	72	30	29	447
FA01F-AHB	4990	5390	5988	72	36	29	476
FA01G-AHB	5330	5757	6396	78	36	29	499

Veneer species must be noted on each line item

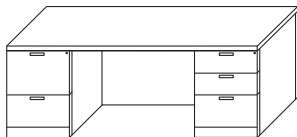

FA01A-BHA	4826	5212	5791	66	30	29	442
FA01C-BHA	4908	5301	5890	66	36	29	461
FA01D-BHA	4908	5301	5890	72	30	29	447
FA01F-BHA	4990	5390	5988	72	36	29	476
FA01G-BHA	5330	5757	6396	78	36	29	499

Veneer species must be noted on each line item

Rectangular Double Pedestal Desk - Flush Modesty Panel

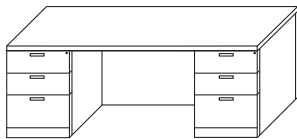

FA02A-AHA	4743	5123	5692	66	30	29	442
FA02C-AHA	4826	5212	5791	66	36	29	461
FA02D-AHA	4826	5212	5791	72	30	29	447
FA02F-AHA	4908	5301	5890	72	36	29	476
FA02G-AHA	5248	5668	6297	78	36	29	499

Veneer species must be noted on each line item

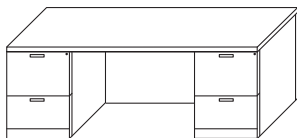

FA02A-BHB	4743	5123	5692	66	30	29	442
FA02C-BHB	4826	5212	5791	66	36	29	461
FA02D-BHB	4826	5212	5791	72	30	29	447
FA02F-BHB	4908	5301	5890	72	36	29	476
FA02G-BHB	5248	5668	6297	78	36	29	499

Veneer species must be noted on each line item

Veneer species must be noted on each line item

Veneer Grade 1	Veneer Grade 2	Veneer Grade 3
Cherry	Rift Oak	Anigre
Maple	Sapele	
Ligno-Grain		
Walnut		

HBF Fairmont Casegoods - Desks

Style Number	List Price			Dimensions			Weight
	Veneer 1	Veneer 2	Veneer 3	OW	OD	OH	

Rectangular Double Pedestal Desk - Flush Modesty Panel

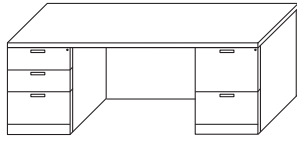

FA02A-AHB	4743	5123	5692	66	30	29	442
FA02C-AHB	4826	5212	5791	66	36	29	461
FA02D-AHB	4826	5212	5791	72	30	29	447
FA02F-AHB	4908	5301	5890	72	36	29	476
FA02G-AHB	5248	5668	6297	78	36	29	499

Veneer species must be noted on each line item

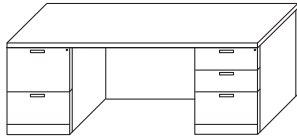

FA02A-BHA	4743	5123	5692	66	30	29	442
FA02C-BHA	4826	5212	5791	66	36	29	461
FA02D-BHA	4826	5212	5791	72	30	29	447
FA02F-BHA	4908	5301	5890	72	36	29	476
FA02G-BHA	5248	5668	6297	78	36	29	499

Veneer species must be noted on each line item

Rectangular Double Pedestal Desk - Recessed Modesty Panel, Front Overhang

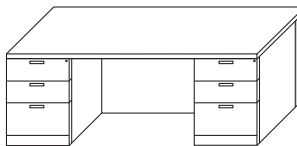

FA05C-AHA	4846	5234	5815	66	36	29	442
FA05H-AHA	4929	5323	5914	66	42	29	461
FA05F-AHA	4949	5345	5939	72	36	29	447
FA05J-AHA	5011	5412	6013	72	42	29	476
FA05K-AHA	5279	5701	6335	78	42	29	499

Veneer species must be noted on each line item

6" overhang visitor side

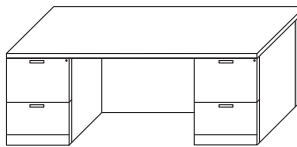

FA05C-BHB	4846	5234	5815	66	36	29	442
FA05H-BHB	4929	5323	5914	66	42	29	461
FA05F-BHB	4949	5345	5939	72	36	29	447
FA05J-BHB	5011	5412	6013	72	42	29	476
FA05K-BHB	5279	5701	6335	78	42	29	499

Veneer species must be noted on each line item

6" overhang visitor side

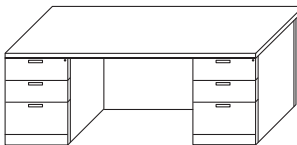

FA06C-AHA	4764	5145	5717	66	36	29	442
FA06H-AHA	4846	5234	5815	66	42	29	461
FA06F-AHA	4867	5256	5840	72	36	29	447
FA06J-AHA	4929	5323	5914	72	42	29	476
FA06K-AHA	5196	5612	6236	78	42	29	499

Veneer species must be noted on each line item

6" overhang visitor side

Veneer species must be noted on each line item

Veneer Grade 1	Veneer Grade 2	Veneer Grade 3
Cherry	Rift Oak	Anigre
Maple	Sapele	
Ligno-Grain		
Walnut		

HBF Fairmont Casegoods - Desks

Style Number	List Price			Dimensions			Weight
	Veneer 1	Veneer 2	Veneer 3	OW	OD	OH	

Rectangular Double Pedestal Desk - Flush Modesty Panel, Front Overhang

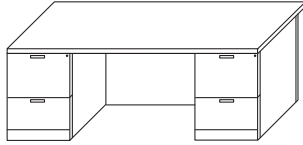

FA06C-BHB	4764	5145	5717	66	36	29	442
FA06H-BHB	4846	5234	5815	66	42	29	461
FA06F-BHB	4867	5256	5840	72	36	29	447
FA06J-BHB	4929	5323	5914	72	42	29	476
FA06K-BHB	5196	5612	6236	78	42	29	499

Veneer species must be noted on each line item

6" overhang visitor side

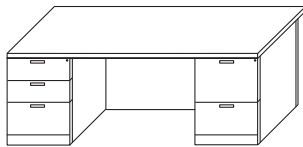

FA06C-AHB	4764	5145	5717	66	36	29	442
FA06H-AHB	4846	5234	5815	66	42	29	461
FA06F-AHB	4867	5256	5840	72	36	29	447
FA06J-AHB	4929	5323	5914	72	42	29	476
FA06K-AHB	5196	5612	6236	78	42	29	499

Veneer species must be noted on each line item

6" overhang visitor side

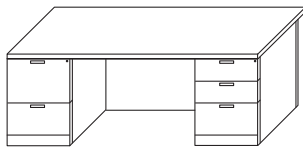

FA06C-BHA	4764	5145	5717	66	36	29	442
FA06H-BHA	4846	5234	5815	66	42	29	461
FA06F-BHA	4867	5256	5840	72	36	29	447
FA06J-BHA	4929	5323	5914	72	42	29	476
FA06K-BHA	5196	5612	6236	78	42	29	499

Veneer species must be noted on each line item

6" overhang visitor side

Bow Front Double Pedestal Desk - Recessed Modesty Panel

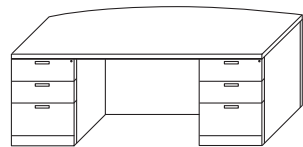

FA03A-AHA	5629	6079	6755	66	30/36	29	464
FA03C-AHA	5722	6179	6866	66	36/42	29	484
FA03D-AHA	5722	6179	6866	72	30/36	29	487
FA03F-AHA	5814	6279	6977	72	36/42	29	508
FA03G-AHA	6185	6680	7422	78	36/42	29	532

Veneer species must be noted on each line item

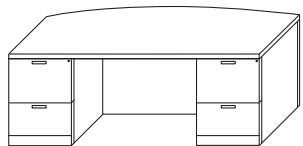

FA03A-BHB	5629	6079	6755	66	30/36	29	464
FA03C-BHB	5722	6179	6866	66	36/42	29	484
FA03D-BHB	5722	6179	6866	72	30/36	29	487
FA03F-BHB	5814	6279	6977	72	36/42	29	508
FA03G-BHB	6185	6680	7422	78	36/42	29	532

Veneer species must be noted on each line item

Veneer species must be noted on each line item

Veneer Grade 1	Veneer Grade 2	Veneer Grade 3
Cherry	Rift Oak	Anigre
Maple	Sapele	
Ligno-Grain		
Walnut		

HBF Fairmont Casegoods - Desks

Style Number	List Price			Dimensions			Weight
	Veneer 1	Veneer 2	Veneer 3	OW	OD	OH	

Bow Front Double Pedestal Desk - Recessed Modesty Panel

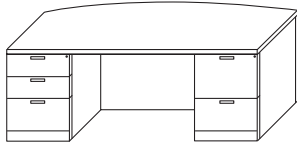

FA03A-AHB	5629	6079	6755	66	30/36	29	464
FA03C-AHB	5722	6179	6866	66	36/42	29	484
FA03D-AHB	5722	6179	6866	72	30/36	29	487
FA03F-AHB	5814	6279	6977	72	36/42	29	508
FA03G-AHB	6185	6680	7422	78	36/42	29	532

Veneer species must be noted on each line item

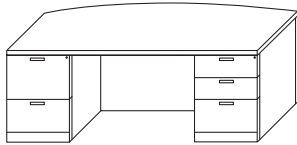

FA03A-BHA	5629	6079	6755	66	30/36	29	464
FA03C-BHA	5722	6179	6866	66	36/42	29	484
FA03D-BHA	5722	6179	6866	72	30/36	29	487
FA03F-BHA	5814	6279	6977	72	36/42	29	508
FA03G-BHA	6185	6680	7422	78	36/42	29	532

Veneer species must be noted on each line item

Bow Front Double Pedestal Desk - Flush Modesty Panel

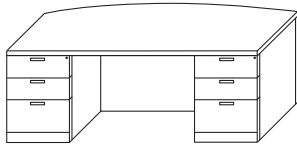

FA04A-AHA	5547	5990	6656	66	30/36	29	464
FA04C-AHA	5639	6090	6767	66	36/42	29	484
FA04D-AHA	5639	6090	6767	72	30/36	29	487
FA04F-AHA	5732	6191	6878	72	36/42	29	508
FA04G-AHA	6103	6591	7323	78	36/42	29	532

Veneer species must be noted on each line item

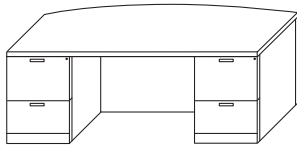

FA04A-BHB	5547	5990	6656	66	30/36	29	464
FA04C-BHB	5639	6090	6767	66	36/42	29	484
FA04D-BHB	5639	6090	6767	72	30/36	29	487
FA04F-BHB	5732	6191	6878	72	36/42	29	508
FA04G-BHB	6103	6591	7323	78	36/42	29	532

Veneer species must be noted on each line item

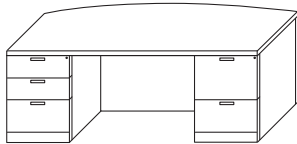

FA04A-AHB	5547	5990	6656	66	30/36	29	464
FA04C-AHB	5639	6090	6767	66	36/42	29	484
FA04D-AHB	5639	6090	6767	72	30/36	29	487
FA04F-AHB	5732	6191	6878	72	36/42	29	508
FA04G-AHB	6103	6591	7323	78	36/42	29	532

Veneer species must be noted on each line item

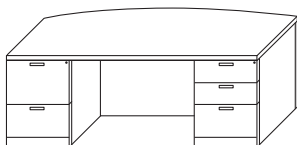

FA04A-BHA	5547	5990	6656	66	30/36	29	464
FA04C-BHA	5639	6090	6767	66	36/42	29	484
FA04D-BHA	5639	6090	6767	72	30/36	29	487
FA04F-BHA	5732	6191	6878	72	36/42	29	508
FA04G-BHA	6103	6591	7323	78	36/42	29	532

Veneer species must be noted on each line item

Veneer species must be noted on each line item

<u>Veneer Grade 1</u>	<u>Veneer Grade 2</u>	<u>Veneer Grade 3</u>
Cherry	Rift Oak	Anigre
Maple	Sapele	
Ligno-Grain		
Walnut		

HBF Fairmont Casegoods - Desks

Style Number	List Price			Dimensions			Weight
	Veneer 1	Veneer 2	Veneer 3	OW	OD	OH	

Rectangular Single Pedestal Desk - Recessed Modesty Panel

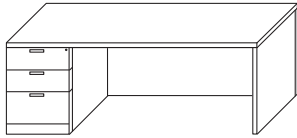

FA10A-AHK	4084	4411	4901	66	30	29	419
FA10C-AHK	4156	4489	4987	66	36	29	439
FA10D-AHK	4156	4489	4987	72	30	29	425
FA10F-AHK	4238	4578	5086	72	36	29	455
FA10G-AHK	4578	4945	5494	78	36	29	479

Veneer species must be noted on each line item

Flush, finished end panels, used with finished back returns and bridges.

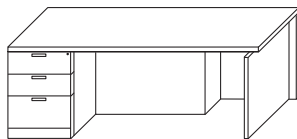

FA10A-AHL	3981	4299	4777	66	30	29	419
FA10C-AHL	4053	4377	4864	66	36	29	439
FA10D-AHL	4053	4377	4864	72	30	29	425
FA10F-AHL	4135	4466	4963	72	36	29	455
FA10G-AHL	4475	4833	5370	78	36	29	479

Veneer species must be noted on each line item

Recessed end panels, used with returns and bridges with removable backs. Standard black outside finish to allow placement against wall.

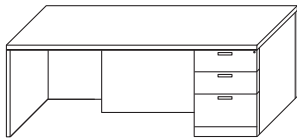

FA10A-KHA	4084	4411	4901	66	30	29	419
FA10C-KHA	4156	4489	4987	66	36	29	439
FA10D-KHA	4156	4489	4987	72	30	29	425
FA10F-KHA	4238	4578	5086	72	36	29	455
FA10G-KHA	4578	4945	5494	78	36	29	479

Veneer species must be noted on each line item

Flush, finished end panels, used with finished back returns and bridges.

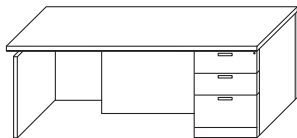

FA10A-LHA	3981	4299	4777	66	30	29	419
FA10C-LHA	4053	4377	4864	66	36	29	439
FA10D-LHA	4053	4377	4864	72	30	29	425
FA10F-LHA	4135	4466	4963	72	36	29	455
FA10G-LHA	4475	4833	5370	78	36	29	479

Veneer species must be noted on each line item

Recessed end panels, used with returns and bridges with removable backs. Standard black outside finish to allow placement against wall.

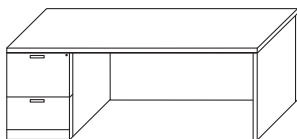

FA10A-BHK	4084	4411	4901	66	30	29	419
FA10C-BHK	4156	4489	4987	66	36	29	439
FA10D-BHK	4156	4489	4987	72	30	29	425
FA10F-BHK	4238	4578	5086	72	36	29	455
FA10G-BHK	4578	4945	5494	78	36	29	479

Veneer species must be noted on each line item

Flush, finished end panels, used with finished back returns and bridges.

Veneer species must be noted on each line item

Veneer Grade 1	Veneer Grade 2	Veneer Grade 3
Cherry	Rift Oak	Anigre
Maple	Sapele	
Ligno-Grain		
Walnut		

HBF Fairmont Casegoods - Desks

Style Number	List Price			Dimensions			Weight
	Veneer 1	Veneer 2	Veneer 3	OW	OD	OH	

Rectangular Single Pedestal Desk - Recessed Modesty Panel

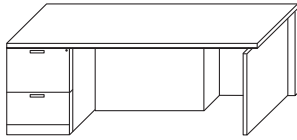

FA10A-BHL	3981	4299	4777	66	30	29	419
FA10C-BHL	4053	4377	4864	66	36	29	439
FA10D-BHL	4053	4377	4864	72	30	29	425
FA10F-BHL	4135	4466	4963	72	36	29	455
FA10G-BHL	4475	4833	5370	78	36	29	479

Veneer species must be noted on each line item

Recessed end panels, used with returns and bridges with removable backs. Standard black outside finish to allow placement against wall.

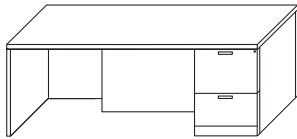

FA10A-KHB	4084	4411	4901	66	30	29	419
FA10C-KHB	4156	4489	4987	66	36	29	439
FA10D-KHB	4156	4489	4987	72	30	29	425
FA10F-KHB	4238	4578	5086	72	36	29	455
FA10G-KHB	4578	4945	5494	78	36	29	479

Veneer species must be noted on each line item

Flush, finished end panels, used with finished back returns and bridges.

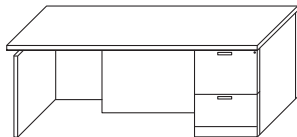

FA10A-LHB	3981	4299	4777	66	30	29	419
FA10C-LHB	4053	4377	4864	66	36	29	439
FA10D-LHB	4053	4377	4864	72	30	29	425
FA10F-LHB	4135	4466	4963	72	36	29	455
FA10G-LHB	4475	4833	5370	78	36	29	479

Veneer species must be noted on each line item

Recessed end panels, used with returns and bridges with removable backs. Standard black outside finish to allow placement against wall.

Rectangular Single Pedestal Desk - Flush Modesty Panel

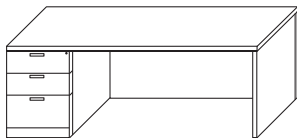

FA11A-AHK	4002	4322	4802	66	30	29	419
FA11C-AHK	4074	4400	4888	66	36	29	439
FA11D-AHK	4074	4400	4888	72	30	29	425
FA11F-AHK	4156	4489	4987	72	36	29	455
FA11G-AHK	4496	4856	5395	78	36	29	479

Veneer species must be noted on each line item

Flush, finished end panels, used with finished back returns and bridges.

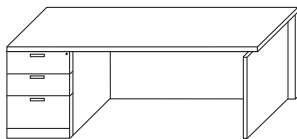

FA11A-AHL	3899	4210	4678	66	30	29	419
FA11C-AHL	3971	4288	4765	66	36	29	439
FA11D-AHL	3971	4288	4765	72	30	29	425
FA11F-AHL	4053	4377	4864	72	36	29	455
FA11G-AHL	4393	4744	5272	78	36	29	479

Veneer species must be noted on each line item

Recessed end panels, used with returns and bridges with removable backs. Standard black outside finish to allow placement against wall.

Veneer species must be noted on each line item

Veneer Grade 1	Veneer Grade 2	Veneer Grade 3
Cherry	Rift Oak	Anigre
Maple	Sapele	
Ligno-Grain		
Walnut		

HBF Fairmont Casegoods - Desks

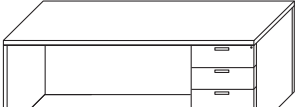
Style Number	List Price			Dimensions			Weight	
	Veneer 1	Veneer 2	Veneer 3	OW	OD	OH		
Rectangular Single Pedestal Desk - Flush Modesty Panel								
	FA11A-KHA	4002	4322	4802	66	30	29	419
	FA11C-KHA	4074	4400	4888	66	36	29	439
	FA11D-KHA	4074	4400	4888	72	30	29	425
	FA11F-KHA	4156	4489	4987	72	36	29	455
	FA11G-KHA	4496	4856	5395	78	36	29	479

Veneer species must be noted on each line item

Flush, finished end panels, used with finished back returns and bridges.

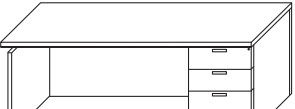
	FA11A-LHA	3899	4210	4678	66	30	29	419
	FA11C-LHA	3971	4288	4765	66	36	29	439
	FA11D-LHA	3971	4288	4765	72	30	29	425
	FA11F-LHA	4053	4377	4864	72	36	29	455
	FA11G-LHA	4393	4744	5272	78	36	29	479

Veneer species must be noted on each line item

Recessed end panels, used with returns and bridges with removable backs. Standard black outside finish to allow placement against wall.

	FA11A-BHK	4002	4322	4802	66	30	29	419
	FA11C-BHK	4074	4400	4888	66	36	29	439
	FA11D-BHK	4074	4400	4888	72	30	29	425
	FA11F-BHK	4156	4489	4987	72	36	29	455
	FA11G-BHK	4496	4856	5395	78	36	29	479

Veneer species must be noted on each line item

Flush, finished end panels, used with finished back returns and bridges.

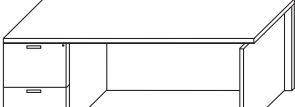
	FA11A-BHL	3899	4210	4678	66	30	29	419
	FA11C-BHL	3971	4288	4765	66	36	29	439
	FA11D-BHL	3971	4288	4765	72	30	29	425
	FA11F-BHL	4053	4377	4864	72	36	29	455
	FA11G-BHL	4393	4744	5272	78	36	29	479

Veneer species must be noted on each line item

Recessed end panels, used with returns and bridges with removable backs. Standard black outside finish to allow placement against wall.

Rectangular Single Pedestal Desk - Recessed Modesty Panel, Front Overhang

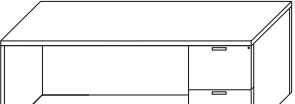
	FA11A-KHB	4002	4322	4802	66	30	29	419
	FA11C-KHB	4074	4400	4888	66	36	29	439
	FA11D-KHB	4074	4400	4888	72	30	29	425
	FA11F-KHB	4156	4489	4987	72	36	29	455
	FA11G-KHB	4496	4856	5395	78	36	29	479

Veneer species must be noted on each line item

Flush, finished end panels, used with finished back returns and bridges.

Veneer species must be noted on each line item

<u>Veneer Grade 1</u>	<u>Veneer Grade 2</u>	<u>Veneer Grade 3</u>
Cherry	Rift Oak	Anigre
Maple	Sapele	
Ligno-Grain		
Walnut		

HBF Fairmont Casegoods - Desks

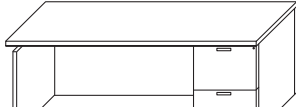
Style Number	List Price			Dimensions			Weight	
	Veneer 1	Veneer 2	Veneer 3	OW	OD	OH		
Rectangular Single Pedestal Desk - Recessed Modesty Panel, Front Overhang								
	FA11A-LHB	3899	4210	4678	66	30	29	419
	FA11C-LHB	3971	4288	4765	66	36	29	439
	FA11D-LHB	3971	4288	4765	72	30	29	425
	FA11F-LHB	4053	4377	4864	72	36	29	455
	FA11G-LHB	4393	4744	5272	78	36	29	479

Veneer species must be noted on each line item

Recessed end panels, used with returns and bridges with removable backs. Standard black outside finish to allow placement against wall.

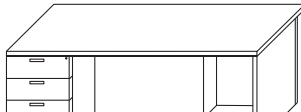
	FA08C-AHK	4105	4433	4925	66	36	29	419
	FA08H-AHK	4177	4511	5012	66	42	29	439
	FA08F-AHK	4177	4511	5012	72	36	29	425
	FA08J-AHK	4259	4600	5111	72	42	29	455
	FA08K-AHK	4599	4967	5519	78	42	29	479

Veneer species must be noted on each line item

Flush, finished end panels, used with finished back returns and bridges. 6" overhang visitor side.

	FA08C-AHL	4002	4322	4802	66	36	29	419
	FA08H-AHL	4074	4400	4888	66	42	29	439
	FA08F-AHL	4074	4400	4888	72	36	29	425
	FA08J-AHL	4156	4489	4987	72	42	29	455
	FA08K-AHL	4496	4856	5395	78	42	29	479

Veneer species must be noted on each line item

Recessed end panels, used with returns and bridges with removable backs. Standard black outside finish to allow placement against wall. 6" overhang visitor side.

	FA08C-KHA	4105	4433	4925	66	36	29	419
	FA08H-KHA	4177	4511	5012	66	42	29	439
	FA08F-KHA	4177	4511	5012	72	36	29	425
	FA08J-KHA	4259	4600	5111	72	42	29	455
	FA08K-KHA	4599	4967	5519	78	42	29	479

Veneer species must be noted on each line item

Flush, finished end panels, used with finished back returns and bridges. 6" overhang visitor side.

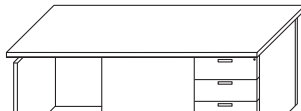
	FA08C-LHA	4002	4322	4802	66	36	29	419
	FA08H-LHA	4074	4400	4888	66	42	29	439
	FA08F-LHA	4074	4400	4888	72	36	29	425
	FA08J-LHA	4156	4489	4987	72	42	29	455
	FA08K-LHA	4496	4856	5395	78	42	29	479

Veneer species must be noted on each line item

Recessed end panels, used with returns and bridges with removable backs. Standard black outside finish to allow placement against wall. 6" overhang visitor side.

Veneer species must be noted on each line item

Veneer Grade 1	Veneer Grade 2	Veneer Grade 3
Cherry	Rift Oak	Anigre
Maple	Sapele	
Ligno-Grain		
Walnut		

HBF Fairmont Casegoods - Desks

Style Number	List Price			Dimensions			Weight
	Veneer 1	Veneer 2	Veneer 3	OW	OD	OH	

Rectangular Single Pedestal Desk - Recessed Modesty Panel, Front Overhang

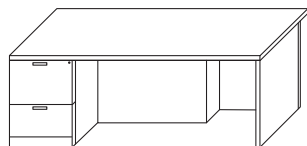

FA08C-BHK	4105	4433	4925	66	36	29	419
FA08H-BHK	4177	4511	5012	66	42	29	439
FA08F-BHK	4177	4511	5012	72	36	29	425
FA08J-BHK	4259	4600	5111	72	42	29	455
FA08K-BHK	4599	4967	5519	78	42	29	479

Veneer species must be noted on each line item

Flush, finished end panels, used with finished back returns and bridges. 6" overhang visitor side.

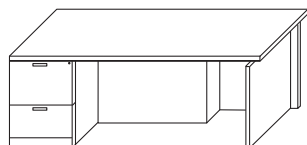

FA08C-BHL	4002	4322	4802	66	36	29	419
FA08H-BHL	4074	4400	4888	66	42	29	439
FA08F-BHL	4074	4400	4888	72	36	29	425
FA08J-BHL	4156	4489	4987	72	42	29	455
FA08K-BHL	4496	4856	5395	78	42	29	479

Veneer species must be noted on each line item

Recessed end panels, used with returns and bridges with removable backs. Standard black outside finish to allow placement against wall. 6" overhang visitor side.

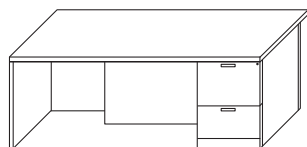

FA08C-KHB	4105	4433	4925	66	36	29	419
FA08H-KHB	4177	4511	5012	66	42	29	439
FA08F-KHB	4177	4511	5012	72	36	29	425
FA08J-KHB	4259	4600	5111	72	42	29	455
FA08K-KHB	4599	4967	5519	78	42	29	479

Veneer species must be noted on each line item

Flush, finished end panels, used with finished back returns and bridges. 6" overhang visitor side.

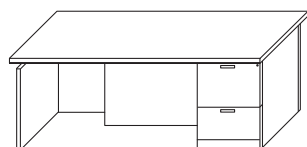

FA08C-LHB	4002	4322	4802	66	36	29	419
FA08H-LHB	4074	4400	4888	66	42	29	439
FA08F-LHB	4074	4400	4888	72	36	29	425
FA08J-LHB	4156	4489	4987	72	42	29	455
FA08K-LHB	4496	4856	5395	78	42	29	479

Veneer species must be noted on each line item

Recessed end panels, used with returns and bridges with removable backs. Standard black outside finish to allow placement against wall. 6" overhang visitor side.

Rectangular Single Pedestal Desk - Flush Modesty Panel, Front Overhang

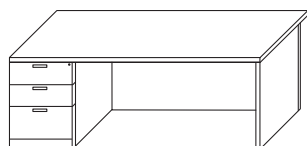

FA09C-AHK	4022	4344	4827	66	36	29	419
FA09H-AHK	4094	4422	4913	66	42	29	439
FA09F-AHK	4094	4422	4913	72	36	29	425
FA09J-AHK	4177	4511	5012	72	42	29	455
FA09K-AHK	4517	4878	5420	78	42	29	479

Veneer species must be noted on each line item

Flush, finished end panels, used with finished back returns and bridges. 6" overhang visitor side.

Veneer species must be noted on each line item

Veneer Grade 1	Veneer Grade 2	Veneer Grade 3
Cherry	Rift Oak	Anigre
Maple	Sapele	
Ligno-Grain		
Walnut		

HBF Fairmont Casegoods - Desks

Style Number	List Price			Dimensions			Weight
	Veneer 1	Veneer 2	Veneer 3	OW	OD	OH	

Rectangular Single Pedestal Desk - Flush Modesty Panel, Front Overhang

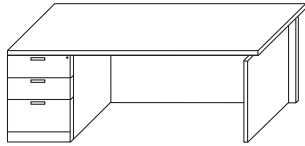

FA09C-AHL	3919	4233	4703	66	36	29	419
FA09H-AHL	3991	4311	4790	66	42	29	439
FA09F-AHL	3991	4311	4790	72	36	29	425
FA09J-AHL	4074	4400	4888	72	42	29	455
FA09K-AHL	4414	4767	5296	78	42	29	479

Veneer species must be noted on each line item

Recessed end panels, used with returns and bridges with removable backs. Standard black outside finish to allow placement against wall. 6" overhang visitor side.

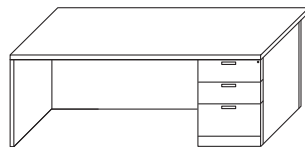

FA09C-KHA	4022	4344	4827	66	36	29	419
FA09H-KHA	4094	4422	4913	66	42	29	439
FA09F-KHA	4094	4422	4913	72	36	29	425
FA09J-KHA	4177	4511	5012	72	42	29	455
FA09K-KHA	4517	4878	5420	78	42	29	479

Veneer species must be noted on each line item

Flush, finished end panels, used with finished back returns and bridges. 6" overhang visitor side.

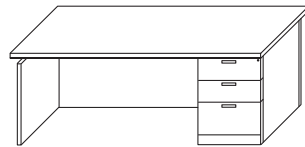

FA09C-LHA	3919	4233	4703	66	36	29	419
FA09H-LHA	3991	4311	4790	66	42	29	439
FA09F-LHA	3991	4311	4790	72	36	29	425
FA09J-LHA	4074	4400	4888	72	42	29	455
FA09K-LHA	4414	4767	5296	78	42	29	479

Veneer species must be noted on each line item

Recessed end panels, used with returns and bridges with removable backs. Standard black outside finish to allow placement against wall. 6" overhang visitor side.

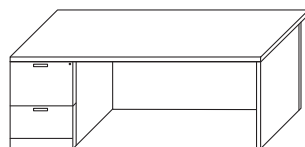

FA09C-BHK	4022	4344	4827	66	36	29	419
FA09H-BHK	4094	4422	4913	66	42	29	439
FA09F-BHK	4094	4422	4913	72	36	29	425
FA09J-BHK	4177	4511	5012	72	42	29	455
FA09K-BHK	4517	4878	5420	78	42	29	479

Veneer species must be noted on each line item

Flush, finished end panels, used with finished back returns and bridges. 6" overhang visitor side.

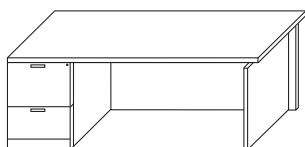

FA09C-BHL	3919	4233	4703	66	36	29	419
FA09H-BHL	3991	4311	4790	66	42	29	439
FA09F-BHL	3991	4311	4790	72	36	29	425
FA09J-BHL	4074	4400	4888	72	42	29	455
FA09K-BHL	4414	4767	5296	78	42	29	479

Veneer species must be noted on each line item

Recessed end panels, used with returns and bridges with removable backs. Standard black outside finish to allow placement against wall. 6" overhang visitor side.

Veneer species must be noted on each line item

Veneer Grade 1	Veneer Grade 2	Veneer Grade 3
Cherry	Rift Oak	Anigre
Maple	Sapele	
Ligno-Grain		
Walnut		

HBF Fairmont Casegoods - Desks

Style Number	List Price			Dimensions			Weight
	Veneer 1	Veneer 2	Veneer 3	OW	OD	OH	

Rectangular Single Pedestal Desk - Flush Modesty Panel, Front Overhang

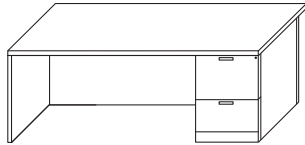

FA09C-KHB	4022	4344	4827	66	36	29	419
FA09H-KHB	4094	4422	4913	66	42	29	439
FA09F-KHB	4094	4422	4913	72	36	29	425
FA09J-KHB	4177	4511	5012	72	42	29	455
FA09K-KHB	4517	4878	5420	78	42	29	479

Veneer species must be noted on each line item

Flush, finished end panels, used with finished back returns and bridges. 6" overhang visitor side.

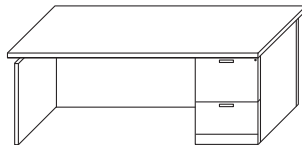

FA09C-LHB	3919	4233	4703	66	36	29	419
FA09H-LHB	3991	4311	4790	66	42	29	439
FA09F-LHB	3991	4311	4790	72	36	29	425
FA09J-LHB	4074	4400	4888	72	42	29	455
FA09K-LHB	4414	4767	5296	78	42	29	479

Veneer species must be noted on each line item

Recessed end panels, used with returns and bridges with removable backs. Standard black outside finish to allow placement against wall. 6" overhang visitor side.

Bow Front Single Pedestal Desk - Recessed Modesty Panel

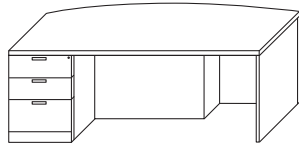

FA12A-AHK	4887	5278	5865	66	30/36	29	443
FA12C-AHK	4959	5356	5951	66	36/42	29	464
FA12D-AHK	4959	5356	5951	72	30/36	29	466
FA12F-AHK	5042	5445	6050	72	36/42	29	488
FA12G-AHK	5382	5812	6458	78	36/42	29	514

Veneer species must be noted on each line item

Flush, finished end panels, used with finished back returns and bridges.

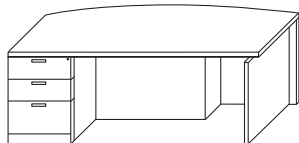

FA12A-AHL	4784	5167	5741	66	30/36	29	443
FA12C-AHL	4856	5245	5828	66	36/42	29	464
FA12D-AHL	4856	5245	5828	72	30/36	29	466
FA12F-AHL	4939	5334	5927	72	36/42	29	488
FA12G-AHL	5279	5701	6335	78	36/42	29	514

Veneer species must be noted on each line item

Recessed end panels, used with returns and bridges with removable backs. Standard black outside finish to allow placement against wall.

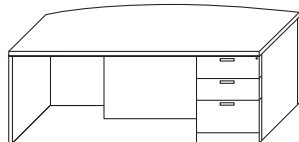

FA12A-KHA	4887	5278	5865	66	30/36	29	443
FA12C-KHA	4959	5356	5951	66	36/42	29	464
FA12D-KHA	4959	5356	5951	72	30/36	29	466
FA12F-KHA	5042	5445	6050	72	36/42	29	488
FA12G-KHA	5382	5812	6458	78	36/42	29	514

Veneer species must be noted on each line item

Flush, finished end panels, used with finished back returns and bridges.

Veneer species must be noted on each line item

Veneer Grade 1	Veneer Grade 2	Veneer Grade 3
Cherry	Rift Oak	Anigre
Maple	Sapele	
Ligno-Grain		
Walnut		

HBF Fairmont Casegoods - Desks

Style Number	List Price			Dimensions			Weight	
	Veneer 1	Veneer 2	Veneer 3	OW	OD	OH		
Bow Front Single Pedestal Desk - Recessed Modesty Panel								
	FA12A-LHA	4784	5167	5741	66	30/36	29	443
	FA12C-LHA	4856	5245	5828	66	36/42	29	464
	FA12D-LHA	4856	5245	5828	72	30/36	29	466
	FA12F-LHA	4939	5334	5927	72	36/42	29	488
	FA12G-LHA	5279	5701	6335	78	36/42	29	514

Veneer species must be noted on each line item

Recessed end panels, used with returns and bridges with removable backs. Standard black outside finish to allow placement against wall.

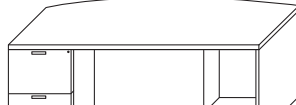
	FA12A-BHK	4887	5278	5865	66	30/36	29	443
	FA12C-BHK	4959	5356	5951	66	36/42	29	464
	FA12D-BHK	4959	5356	5951	72	30/36	29	466
	FA12F-BHK	5042	5445	6050	72	36/42	29	488
	FA12G-BHK	5382	5812	6458	78	36/42	29	514

Veneer species must be noted on each line item

Flush, finished end panels, used with finished back returns and bridges.

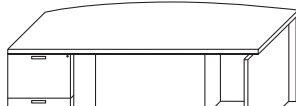
	FA12A-BHL	4784	5167	5741	66	30/36	29	443
	FA12C-BHL	4856	5245	5828	66	36/42	29	464
	FA12D-BHL	4856	5245	5828	72	30/36	29	466
	FA12F-BHL	4939	5334	5927	72	36/42	29	488
	FA12G-BHL	5279	5701	6335	78	36/42	29	514

Veneer species must be noted on each line item

Recessed end panels, used with returns and bridges with removable backs. Standard black outside finish to allow placement against wall.

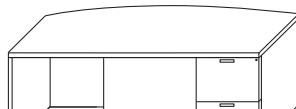
	FA12A-KHB	4887	5278	5865	66	30/36	29	443
	FA12C-KHB	4959	5356	5951	66	36/42	29	464
	FA12D-KHB	4959	5356	5951	72	30/36	29	466
	FA12F-KHB	5042	5445	6050	72	36/42	29	488
	FA12G-KHB	5382	5812	6458	78	36/42	29	514

Veneer species must be noted on each line item

Flush, finished end panels, used with finished back returns and bridges.

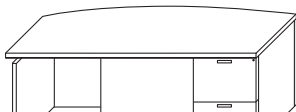
	FA12A-LHB	4784	5167	5741	66	30/36	29	443
	FA12C-LHB	4856	5245	5828	66	36/42	29	464
	FA12D-LHB	4856	5245	5828	72	30/36	29	466
	FA12F-LHB	4939	5334	5927	72	36/42	29	488
	FA12G-LHB	5279	5701	6335	78	36/42	29	514

Veneer species must be noted on each line item

Recessed end panels, used with returns and bridges with removable backs. Standard black outside finish to allow placement against wall.

Veneer species must be noted on each line item

<u>Veneer Grade 1</u>	<u>Veneer Grade 2</u>	<u>Veneer Grade 3</u>
Cherry	Rift Oak	Anigre
Maple	Sapele	
Ligno-Grain		
Walnut		

HBF Fairmont Casegoods - Desks

Style Number	List Price			Dimensions			Weight	
	Veneer 1	Veneer 2	Veneer 3	OW	OD	OH		
Bow Front Single Pedestal Desk - Flush Modesty Panel								
	FA13A-AHK	4805	5189	5766	66	30/36	29	443
	FA13C-AHK	4877	5267	5852	66	36/42	29	464
	FA13D-AHK	4877	5267	5852	72	30/36	29	466
	FA13F-AHK	4959	5356	5951	72	36/42	29	488
	FA13G-AHK	5299	5723	6359	78	36/42	29	514

Veneer species must be noted on each line item

Flush, finished end panels, used with finished back returns and bridges.

	FA13A-AHL	4702	5078	5642	66	30/36	29	443
	FA13C-AHL	4774	5156	5729	66	36/42	29	464
	FA13D-AHL	4774	5156	5729	72	30/36	29	466
	FA13F-AHL	4856	5245	5828	72	36/42	29	488
	FA13G-AHL	5196	5612	6236	78	36/42	29	514

Veneer species must be noted on each line item

Recessed end panels, used with returns and bridges with removable backs. Standard black outside finish to allow placement against wall.

	FA13A-KHA	4805	5189	5766	66	30/36	29	443
	FA13C-KHA	4877	5267	5852	66	36/42	29	464
	FA13D-KHA	4877	5267	5852	72	30/36	29	466
	FA13F-KHA	4959	5356	5951	72	36/42	29	488
	FA13G-KHA	5299	5723	6359	78	36/42	29	514

Veneer species must be noted on each line item

Flush, finished end panels, used with finished back returns and bridges.

	FA13A-LHA	4702	5078	5642	66	30/36	29	443
	FA13C-LHA	4774	5156	5729	66	36/42	29	464
	FA13D-LHA	4774	5156	5729	72	30/36	29	466
	FA13F-LHA	4856	5245	5828	72	36/42	29	488
	FA13G-LHA	5196	5612	6236	78	36/42	29	514

Veneer species must be noted on each line item

Recessed end panels, used with returns and bridges with removable backs. Standard black outside finish to allow placement against wall.

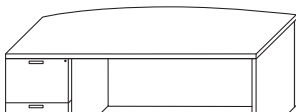
	FA13A-BHK	4805	5189	5766	66	30/36	29	443
	FA13C-BHK	4877	5267	5852	66	36/42	29	464
	FA13D-BHK	4877	5267	5852	72	30/36	29	466
	FA13F-BHK	4959	5356	5951	72	36/42	29	488
	FA13G-BHK	5299	5723	6359	78	36/42	29	514

Veneer species must be noted on each line item

Flush, finished end panels, used with finished back returns and bridges.

Veneer species must be noted on each line item

<u>Veneer Grade 1</u>	<u>Veneer Grade 2</u>	<u>Veneer Grade 3</u>
Cherry	Rift Oak	Anigre
Maple	Sapele	
Ligno-Grain		
Walnut		

HBF Fairmont Casegoods - Desks

Style Number	List Price			Dimensions			Weight
	Veneer 1	Veneer 2	Veneer 3	OW	OD	OH	

Bow Front Single Pedestal Desk - Flush Modesty Panel

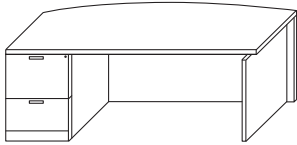

FA13A-BHL	4702	5078	5642	66	30/36	29	443
FA13C-BHL	4774	5156	5729	66	36/42	29	464
FA13D-BHL	4774	5156	5729	72	30/36	29	466
FA13F-BHL	4856	5245	5828	72	36/42	29	488
FA13G-BHL	5196	5612	6236	78	36/42	29	514

Veneer species must be noted on each line item

Recessed end panels, used with returns and bridges with removable backs. Standard black outside finish to allow placement against wall.

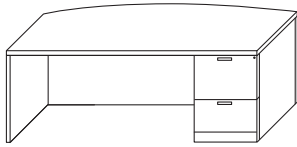

FA13A-KHB	4805	5189	5766	66	30/36	29	443
FA13C-KHB	4877	5267	5852	66	36/42	29	464
FA13D-KHB	4877	5267	5852	72	30/36	29	466
FA13F-KHB	4959	5356	5951	72	36/42	29	488
FA13G-KHB	5299	5723	6359	78	36/42	29	514

Veneer species must be noted on each line item

Flush, finished end panels, used with finished back returns and bridges.

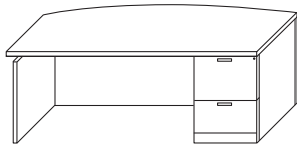

FA13A-LHB	4702	5078	5642	66	30/36	29	443
FA13C-LHB	4774	5156	5729	66	36/42	29	464
FA13D-LHB	4774	5156	5729	72	30/36	29	466
FA13F-LHB	4856	5245	5828	72	36/42	29	488
FA13G-LHB	5196	5612	6236	78	36/42	29	514

Veneer species must be noted on each line item

Recessed end panels, used with returns and bridges with removable backs. Standard black outside finish to allow placement against wall.

Veneer species must be noted on each line item

Veneer Grade 1	Veneer Grade 2	Veneer Grade 3
Cherry	Rift Oak	Anigre
Maple	Sapele	
Ligno-Grain		
Walnut		

HBF Fairmont Casegoods - Table Desks

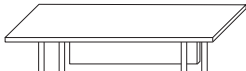
Style Number	List Price			Dimensions			Weight	
	Veneer 1	Veneer 2	Veneer 3	OW	OD	OH		
	FA07A-T	3672	3966	4406	66	30	29	199
	FA07D-T	3693	3988	4431	72	30	29	224
	FA07F-T	3765	4066	4518	72	36	29	252

Veneer species must be noted on each line item

Center drawer, modesty panel. Metal legs available in satin nickel or black powder coat finish, please specify on order. Casters available on all table desks, please specify on order. Optional border inlay available on top surface of Fairmont only, add \$650 List.

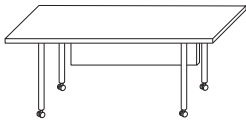

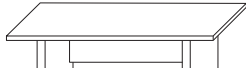
	FA07A-M	4290	4633	5148	66	30	29	239
	FA07D-M	4311	4655	5173	72	30	29	264
	FA07F-M	4383	4733	5259	72	36	29	282

Veneer species must be noted on each line item

Center drawer, modesty panel, panel base. Optional border inlay available on top surface of Fairmont only, add \$650 List.

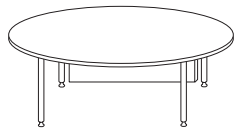

FA18K-T	4393	4744	5272	78	42	29	265
---------	------	------	------	----	----	----	-----

Veneer species must be noted on each line item

Ellipse with center drawer, modesty panel. Metal legs available in satin nickel or black powder coat finish, please specify on order. Casters available on all table desks, please specify on order.

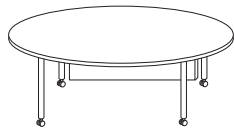

	FA19A-T	4393	4744	5272	66	30/36	29	209
	FA19D-T	4414	4767	5296	72	30/36	29	234
	FA19F-T	4486	4845	5383	72	36/42	29	262

Veneer species must be noted on each line item

Bow front with center drawer, modesty panel. Metal legs available in satin nickel or black powder coat finish, please specify on order. Casters available on all table desks, please specify on order. Optional border inlay available on top surface of Fairmont only, add \$650 List.

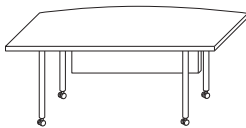

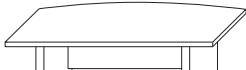
	FA19A-M	5011	5412	6013	66	30/36	29	249
	FA19D-M	5032	5434	6038	72	30/36	29	274
	FA19F-M	5104	5512	6124	72	36/42	29	292

Veneer species must be noted on each line item

Bow front with center drawer, modesty panel and panel base. Optional border inlay available on top surface of Fairmont only, add \$850 List.

Veneer species must be noted on each line item

<u>Veneer Grade 1</u>	<u>Veneer Grade 2</u>	<u>Veneer Grade 3</u>
Cherry	Rift Oak	Anigre
Maple	Sapele	
Ligno-Grain		
Walnut		

HBF Fairmont Casegoods - Credenzas

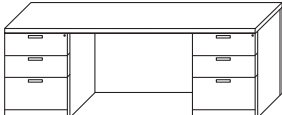
Style Number	List Price			Dimensions			Weight	
	Veneer 1	Veneer 2	Veneer 3	OW	OD	OH		
Double Pedestal Credenza								
	FA31D-AGA	4018	4340	4821	66	24	29	437
	FA31E-AGA	4121	4450	4945	72	24	29	447
	FA31F-AGA	4265	4606	5118	78	24	29	457
	FA31G-AGA	4311	4650	5174	84	24	29	465
	FA31H-AGA	4368	4717	5242	90	24	29	475
	FA31J-AGA	4414	4767	5297	96	24	29	485

Veneer species must be noted on each line item
Removable access panel with standard black unfinished back.

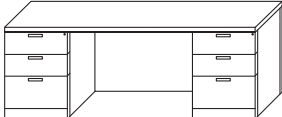
	FA32D-AGA	4018	4340	4821	66	24	29	437
	FA32E-AGA	4121	4450	4945	72	24	29	447
	FA32F-AGA	4265	4606	5118	78	24	29	457
	FA32G-AGA	4311	4650	5174	84	24	29	465
	FA32H-AGA	4368	4717	5242	90	24	29	475
	FA32J-AGA	4414	4767	5297	96	24	29	485

Veneer species must be noted on each line item
Removable access panel with standard black unfinished back.

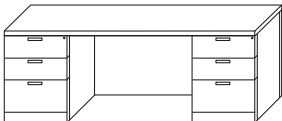
	FA33D-AGA	4018	4340	4821	66	24	29	437
	FA33E-AGA	4121	4450	4945	72	24	29	447
	FA33F-AGA	4265	4606	5118	78	24	29	457
	FA33G-AGA	4311	4650	5174	84	24	29	465
	FA33H-AGA	4368	4717	5242	90	24	29	475
	FA33J-AGA	4414	4767	5297	96	24	29	485

Veneer species must be noted on each line item
Removable access panel with standard black unfinished back.

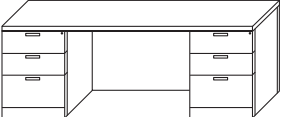
	FA34D-AHA	4368	4717	5242	66	25	29	488
	FA34E-AHA	4409	4762	5291	72	25	29	501
	FA34F-AHA	4754	5135	5705	78	25	29	515
	FA34G-AHA	4800	5185	5761	84	25	29	527
	FA34H-AHA	4949	5346	5940	90	25	29	541
	FA34J-AHA	4996	5396	5995	96	25	29	555

Veneer species must be noted on each line item
Finished, fixed back panel.

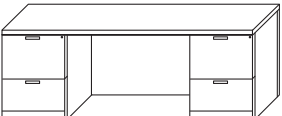
	FA31D-BGB	4018	4340	4821	66	24	29	437
	FA31E-BGB	4121	4450	4945	72	24	29	447
	FA31F-BGB	4265	4606	5118	78	24	29	457
	FA31G-BGB	4311	4650	5174	84	24	29	465
	FA31H-BGB	4368	4717	5242	90	24	29	475
	FA31J-BGB	4414	4767	5297	96	24	29	485

Veneer species must be noted on each line item
Removable access panel with standard black unfinished back.

Veneer species must be noted on each line item

Veneer Grade 1	Veneer Grade 2	Veneer Grade 3
Cherry	Rift Oak	Anigre
Maple	Sapele	
Ligno-Grain		
Walnut		

HBF Fairmont Casegoods - Credenzas

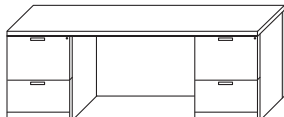
Style Number	List Price			Dimensions			Weight	
	Veneer 1	Veneer 2	Veneer 3	OW	OD	OH		
Double Pedestal Credenza								
	FA32D-BGB	4018	4340	4821	66	24	29	437
	FA32E-BGB	4121	4450	4945	72	24	29	447
	FA32F-BGB	4265	4606	5118	78	24	29	457
	FA32G-BGB	4311	4650	5174	84	24	29	465
	FA32H-BGB	4368	4717	5242	90	24	29	475
	FA32J-BGB	4414	4767	5297	96	24	29	485

Veneer species must be noted on each line item
Removable access panel with standard black unfinished back.

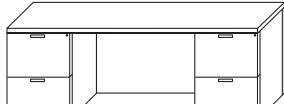
	FA33D-BGB	4018	4340	4821	66	24	29	437
	FA33E-BGB	4121	4450	4945	72	24	29	447
	FA33F-BGB	4265	4606	5118	78	24	29	457
	FA33G-BGB	4311	4650	5174	84	24	29	465
	FA33H-BGB	4368	4717	5242	90	24	29	475
	FA33J-BGB	4414	4767	5297	96	24	29	485

Veneer species must be noted on each line item
Removable access panel with standard black unfinished back.

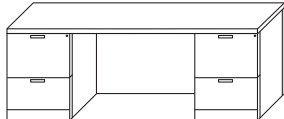
	FA34D-BHB	4368	4717	5242	66	25	29	488
	FA34E-BHB	4409	4762	5291	72	25	29	501
	FA34F-BHB	4754	5135	5705	78	25	29	515
	FA34G-BHB	4800	5185	5761	84	25	29	527
	FA34H-BHB	4949	5346	5940	90	25	29	541
	FA34J-BHB	4996	5396	5995	96	25	29	555

Veneer species must be noted on each line item
Finished, fixed back panel.

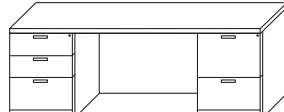
	FA31D-AGB	4018	4340	4821	66	24	29	437
	FA31E-AGB	4121	4450	4945	72	24	29	447
	FA31F-AGB	4265	4606	5118	78	24	29	457
	FA31G-AGB	4311	4650	5174	84	24	29	465
	FA31H-AGB	4368	4717	5242	90	24	29	475
	FA31J-AGB	4414	4767	5297	96	24	29	485

Veneer species must be noted on each line item
Removable access panel with standard black unfinished back.

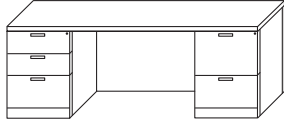
	FA32D-AGB	4018	4340	4821	66	24	29	437
	FA32E-AGB	4121	4450	4945	72	24	29	447
	FA32F-AGB	4265	4606	5118	78	24	29	457
	FA32G-AGB	4311	4650	5174	84	24	29	465
	FA32H-AGB	4368	4717	5242	90	24	29	475
	FA32J-AGB	4414	4767	5297	96	24	29	485

Veneer species must be noted on each line item
Removable access panel with standard black unfinished back.

Veneer species must be noted on each line item

<u>Veneer Grade 1</u>	<u>Veneer Grade 2</u>	<u>Veneer Grade 3</u>
Cherry	Rift Oak	Anigre
Maple	Sapele	
Ligno-Grain		
Walnut		

HBF Fairmont Casegoods - Credenzas

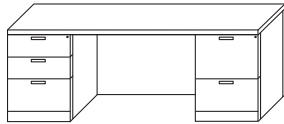
Style Number	List Price			Dimensions			Weight	
	Veneer 1	Veneer 2	Veneer 3	OW	OD	OH		
Double Pedestal Credenza								
	FA33D-AGB	4018	4340	4821	66	24	29	437
	FA33E-AGB	4121	4450	4945	72	24	29	447
	FA33F-AGB	4265	4606	5118	78	24	29	457
	FA33G-AGB	4311	4650	5174	84	24	29	465
	FA33H-AGB	4368	4717	5242	90	24	29	475
	FA33J-AGB	4414	4767	5297	96	24	29	485

Veneer species must be noted on each line item

Removable access panel with standard black unfinished back.

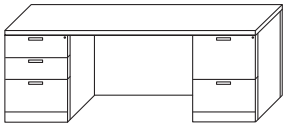
	FA34D-AHB	4368	4717	5242	66	25	29	488
	FA34E-AHB	4409	4762	5291	72	25	29	501
	FA34F-AHB	4754	5135	5705	78	25	29	515
	FA34G-AHB	4800	5185	5761	84	25	29	527
	FA34H-AHB	4949	5346	5940	90	25	29	541
	FA34J-AHB	4996	5396	5995	96	25	29	555

Veneer species must be noted on each line item

Finished, fixed back panel.

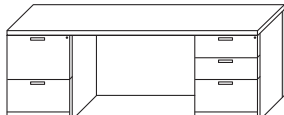
	FA31D-BGA	4018	4340	4821	66	24	29	437
	FA31E-BGA	4121	4450	4945	72	24	29	447
	FA31F-BGA	4265	4606	5118	78	24	29	457
	FA31G-BGA	4311	4650	5174	84	24	29	465
	FA31H-BGA	4368	4717	5242	90	24	29	475
	FA31J-BGA	4414	4767	5297	96	24	29	485

Veneer species must be noted on each line item

Removable access panel with standard black unfinished back.

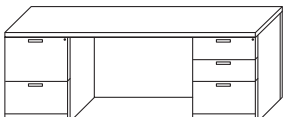
	FA32D-BGA	4018	4340	4821	66	24	29	437
	FA32E-BGA	4121	4450	4945	72	24	29	447
	FA32F-BGA	4265	4606	5118	78	24	29	457
	FA32G-BGA	4311	4650	5174	84	24	29	465
	FA32H-BGA	4368	4717	5242	90	24	29	475
	FA32J-BGA	4414	4767	5297	96	24	29	485

Veneer species must be noted on each line item

Removable access panel with standard black unfinished back.

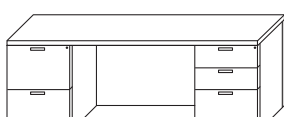
	FA33D-BGA	4018	4340	4821	66	24	29	437
	FA33E-BGA	4121	4450	4945	72	24	29	447
	FA33F-BGA	4265	4606	5118	78	24	29	457
	FA33G-BGA	4311	4650	5174	84	24	29	465
	FA33H-BGA	4368	4717	5242	90	24	29	475
	FA33J-BGA	4414	4767	5297	96	24	29	485

Veneer species must be noted on each line item

Removable access panel with standard black unfinished back.

Veneer species must be noted on each line item

<u>Veneer Grade 1</u>	<u>Veneer Grade 2</u>	<u>Veneer Grade 3</u>
Cherry	Rift Oak	Anigre
Maple	Sapele	
Ligno-Grain		
Walnut		

HBF Fairmont Casegoods - Credenzas

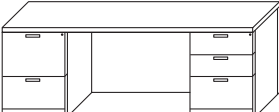
Style Number	List Price			Dimensions			Weight	
	Veneer 1	Veneer 2	Veneer 3	OW	OD	OH		
Double Pedestal Credenza								
	FA34D-BHA	4368	4717	5242	66	25	29	488
	FA34E-BHA	4409	4762	5291	72	25	29	501
	FA34F-BHA	4754	5135	5705	78	25	29	515
	FA34G-BHA	4800	5185	5761	84	25	29	527
	FA34H-BHA	4949	5346	5940	90	25	29	541
	FA34J-BHA	4996	5396	5995	96	25	29	555

Veneer species must be noted on each line item

Finished, fixed back panel.

Single Pedestal Credenza

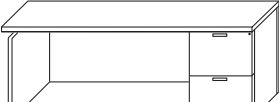
	FA31D-LGB	2937	3171	3523	66	24	29	326
	FA31E-LGB	2978	3215	3573	72	24	29	336
	FA31F-LGB	3122	3371	3746	78	24	29	346
	FA31G-LGB	3492	3772	4191	84	24	29	372
	FA31H-LGB	3549	3833	4259	90	24	29	390
	FA31J-LGB	3595	3883	4314	96	24	29	408

Veneer species must be noted on each line item

Removable access panel with standard black unfinished back.

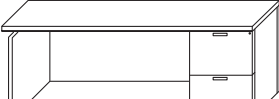
	FA32D-LGB	2937	3171	3523	66	24	29	326
	FA32E-LGB	2978	3215	3573	72	24	29	336
	FA32F-LGB	3122	3371	3746	78	24	29	346
	FA32G-LGB	3492	3772	4191	84	24	29	372
	FA32H-LGB	3549	3833	4259	90	24	29	390
	FA32J-LGB	3595	3883	4314	96	24	29	408

Veneer species must be noted on each line item

Removable access panel with standard black unfinished back.

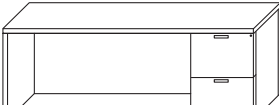
	FA33D-KGB	3122	3371	3745	66	24	29	326
	FA33E-KGB	3163	3415	3795	72	24	29	336
	FA33F-KGB	3307	3571	3968	78	24	29	346
	FA33G-KGB	3677	3972	4413	84	24	29	372
	FA33H-KGB	3734	4033	4481	90	24	29	390
	FA33J-KGB	3780	4083	4536	96	24	29	408

Veneer species must be noted on each line item

Removable access panel with standard black unfinished back.

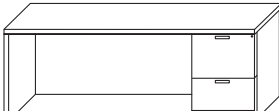
	FA34D-KHB	3410	3682	4091	66	25	29	377
	FA34E-KHB	3451	3727	4141	72	25	29	390
	FA34F-KHB	3796	4100	4555	78	25	29	404
	FA34G-KHB	3842	4150	4611	84	25	29	434
	FA34H-KHB	3991	4311	4790	90	25	29	456
	FA34J-KHB	4038	4361	4845	96	25	29	478

Veneer species must be noted on each line item

Finished, fixed back panel.

Veneer species must be noted on each line item

Veneer Grade 1	Veneer Grade 2	Veneer Grade 3
Cherry	Rift Oak	Anigre
Maple	Sapele	
Ligno-Grain		
Walnut		

HBF Fairmont Casegoods - Credenzas

Style Number	List Price			Dimensions			Weight
	Veneer 1	Veneer 2	Veneer 3	OW	OD	OH	

Single Pedestal Credenza

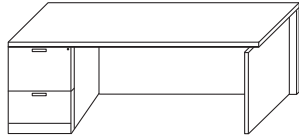

FA31D-BGL	2937	3171	3523	66	24	29	326
FA31E-BGL	2978	3215	3573	72	24	29	336
FA31F-BGL	3122	3371	3746	78	24	29	346
FA31G-BGL	3492	3772	4191	84	24	29	372
FA31H-BGL	3549	3833	4259	90	24	29	390
FA31J-BGL	3595	3883	4314	96	24	29	408

Veneer species must be noted on each line item

Removable access panel with standard black unfinished back.

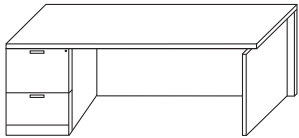

FA32D-BGL	2937	3171	3523	66	24	29	326
FA32E-BGL	2978	3215	3573	72	24	29	336
FA32F-BGL	3122	3371	3746	78	24	29	346
FA32G-BGL	3492	3772	4191	84	24	29	372
FA32H-BGL	3549	3833	4259	90	24	29	390
FA32J-BGL	3595	3883	4314	96	24	29	408

Veneer species must be noted on each line item

Removable access panel with standard black unfinished back.

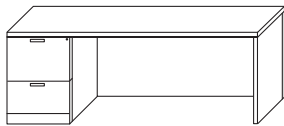

FA33D-BGK	3122	3371	3745	66	24	29	326
FA33E-BGK	3163	3415	3795	72	24	29	336
FA33F-BGK	3307	3571	3968	78	24	29	346
FA33G-BGK	3677	3972	4413	84	24	29	372
FA33H-BGK	3734	4033	4481	90	24	29	390
FA33J-BGK	3780	4083	4536	96	24	29	408

Veneer species must be noted on each line item

Removable access panel with standard black unfinished back.

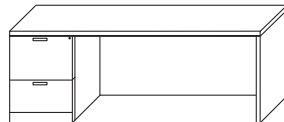

FA34D-BHK	3410	3682	4091	66	25	29	377
FA34E-BHK	3451	3727	4141	72	25	29	390
FA34F-BHK	3796	4100	4555	78	25	29	404
FA34G-BHK	3842	4150	4611	84	25	29	434
FA34H-BHK	3991	4311	4790	90	25	29	456
FA34J-BHK	4038	4361	4845	96	25	29	478

Veneer species must be noted on each line item

Finished, fixed back panel.

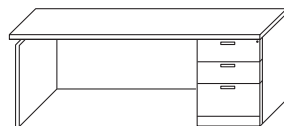

FA31D-LGA	2937	3171	3523	66	24	29	326
FA31E-LGA	2978	3215	3573	72	24	29	336
FA31F-LGA	3122	3371	3746	78	24	29	346
FA31G-LGA	3492	3772	4191	84	24	29	372
FA31H-LGA	3549	3833	4259	90	24	29	390
FA31J-LGA	3595	3883	4314	96	24	29	408

Veneer species must be noted on each line item

Removable access panel with standard black unfinished back.

Veneer species must be noted on each line item

Veneer Grade 1	Veneer Grade 2	Veneer Grade 3
Cherry	Rift Oak	Anigre
Maple	Sapele	
Ligno-Grain		
Walnut		

HBF Fairmont Casegoods - Credenzas

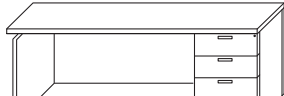
Style Number	List Price			Dimensions			Weight	
	Veneer 1	Veneer 2	Veneer 3	OW	OD	OH		
Single Pedestal Credenza								
	FA32D-LGA	2937	3171	3523	66	24	29	326
	FA32E-LGA	2978	3215	3573	72	24	29	336
	FA32F-LGA	3122	3371	3746	78	24	29	346
	FA32G-LGA	3492	3772	4191	84	24	29	372
	FA32H-LGA	3549	3833	4259	90	24	29	390
	FA32J-LGA	3595	3883	4314	96	24	29	408

Veneer species must be noted on each line item

Removable access panel with standard black unfinished back.

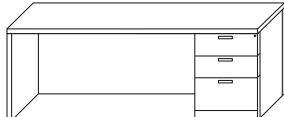
	FA33D-KGA	3122	3371	3745	66	24	29	326
	FA33E-KGA	3163	3415	3795	72	24	29	336
	FA33F-KGA	3307	3571	3968	78	24	29	346
	FA33G-KGA	3677	3972	4413	84	24	29	372
	FA33H-KGA	3734	4033	4481	90	24	29	390
	FA33J-KGA	3780	4083	4536	96	24	29	408

Veneer species must be noted on each line item

Removable access panel with standard black unfinished back.

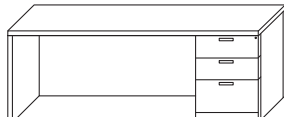
	FA34D-KHA	3410	3682	4091	66	25	29	377
	FA34E-KHA	3451	3727	4141	72	25	29	390
	FA34F-KHA	3796	4100	4555	78	25	29	404
	FA34G-KHA	3842	4150	4611	84	25	29	434
	FA34H-KHA	3991	4311	4790	90	25	29	456
	FA34J-KHA	4038	4361	4845	96	25	29	478

Veneer species must be noted on each line item

Finished, fixed back panel.

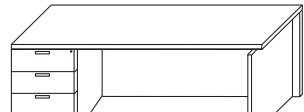
	FA31D-AGL	2937	3171	3523	66	24	29	326
	FA31E-AGL	2978	3215	3573	72	24	29	336
	FA31F-AGL	3122	3371	3746	78	24	29	346
	FA31G-AGL	3492	3772	4191	84	24	29	372
	FA31H-AGL	3549	3833	4259	90	24	29	390
	FA31J-AGL	3595	3883	4314	96	24	29	408

Veneer species must be noted on each line item

Removable access panel with standard black unfinished back.

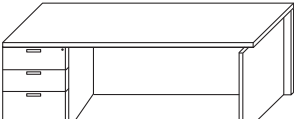
	FA32D-AGL	2937	3171	3523	66	24	29	326
	FA32E-AGL	2978	3215	3573	72	24	29	336
	FA32F-AGL	3122	3371	3746	78	24	29	346
	FA32G-AGL	3492	3772	4191	84	24	29	372
	FA32H-AGL	3549	3833	4259	90	24	29	390
	FA32J-AGL	3595	3883	4314	96	24	29	408

Veneer species must be noted on each line item

Removable access panel with standard black unfinished back.

Veneer species must be noted on each line item

<u>Veneer Grade 1</u>	<u>Veneer Grade 2</u>	<u>Veneer Grade 3</u>
Cherry	Rift Oak	Anigre
Maple	Sapele	
Ligno-Grain		
Walnut		

HBF Fairmont Casegoods - Credenzas

Style Number	List Price			Dimensions			Weight
	Veneer 1	Veneer 2	Veneer 3	OW	OD	OH	

Single Pedestal Credenza

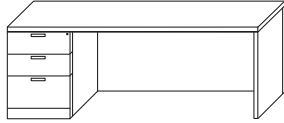

FA33D-AGK	3122	3371	3745	66	24	29	326
FA33E-AGK	3163	3415	3795	72	24	29	336
FA33F-AGK	3307	3571	3968	78	24	29	346
FA33G-AGK	3677	3972	4413	84	24	29	372
FA33H-AGK	3734	4033	4481	90	24	29	390
FA33J-AGK	3780	4083	4536	96	24	29	408

Veneer species must be noted on each line item

Removable access panel with standard black unfinished back.

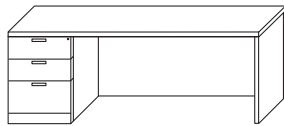

FA34D-AHK	3410	3682	4091	66	25	29	377
FA34E-AHK	3451	3727	4141	72	25	29	390
FA34F-AHK	3796	4100	4555	78	25	29	404
FA34G-AHK	3842	4150	4611	84	25	29	434
FA34H-AHK	3991	4311	4790	90	25	29	456
FA34J-AHK	4038	4361	4845	96	25	29	478

Veneer species must be noted on each line item

Finished, fixed back panel.

Double Pedestal Credenza, Center Doors

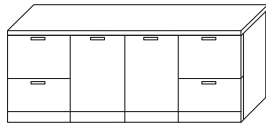

FA31D-BEB	5043	5446	6051	66	24	29	400
FA32D-BEB	5043	5446	6051	66	24	29	400
FA33D-BEB	5043	5446	6051	66	24	29	400
FA34D-BEB	5728	6185	6873	66	25	29	400

Veneer species must be noted on each line item

Two-door cabinet is 30" OW, one adjustable shelf.

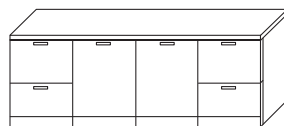

FA31E-BFB	5109	5518	6131	72	24	29	415
FA32E-BFB	5109	5518	6131	72	24	29	415
FA33E-BFB	5109	5518	6131	72	24	29	415
FA34E-BFB	5794	6258	6953	72	25	29	415

Veneer species must be noted on each line item

Two-door cabinet is 36" OW, one adjustable shelf.

Veneer species must be noted on each line item

<u>Veneer Grade 1</u>	<u>Veneer Grade 2</u>	<u>Veneer Grade 3</u>
Cherry	Rift Oak	Anigre
Maple	Sapele	
Ligno-Grain		
Walnut		

HBF Fairmont Casegoods - Credenzas

Style Number	List Price			Dimensions			Weight
	Veneer 1	Veneer 2	Veneer 3	OW	OD	OH	

Credenza, Doors

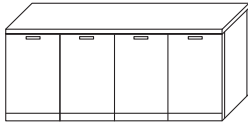

FA31C-EE	3693	3987	4432	60	24	29	423
FA32C-EE	3693	3987	4432	60	24	29	423
FA33C-EE	3693	3987	4432	60	24	29	423
FA34C-EE	4383	4733	5260	60	25	29	423

Veneer species must be noted on each line item

Two-door cabinet is 30" OW, one adjustable shelf per cabinet.

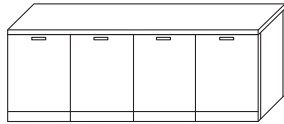

FA31E-FF	3826	4132	4591	72	24	29	453
FA32E-FF	3826	4132	4591	72	24	29	453
FA33E-FF	3826	4132	4591	72	24	29	453
FA34E-FF	4511	4872	5413	72	25	29	453

Veneer species must be noted on each line item

Two-door cabinet is 36" OW, one adjustable shelf per cabinet.

Veneer species must be noted on each line item

<u>Veneer Grade 1</u>	<u>Veneer Grade 2</u>	<u>Veneer Grade 3</u>
Cherry	Rift Oak	Anigre
Maple	Sapele	
Ligno-Grain		
Walnut		

HBF Fairmont Casegoods - Credenzas

Credenzas - Other Configurations

HBF Fairmont credenzas are offered in many different sizes and pedestal configurations for maximum flexibility. For ease in specification, use the style number creation system described below. This system allows you to select a variety of credenza widths and place components in any configuration. Credenza pricing is calculated by totaling the individual prices of all components and the credenza top price. *Several commonly used credenzas are listed on the previous pages for your convenience.*

Style Number Creation System

Example Credenza

<u>Product Code</u>	<u>Width Code</u>	=	<u>Component Configuration</u>
31 ↓	H ↓		ABGK ↓
31 Credenza - Front finished	M 18"		A Box/Box/File 18"
32 Credenza - Front and one end finished	N 24"		B File/File 18"
33 Credenza - Front and both ends finished	P 30"		C Lateral File 30"
34 Credenza - Front, back and both ends finished	R 36"		D Lateral File 36"
	S 42"		M Open Lateral File 30"
	A 48"		N Open Lateral File 36"
	B 54"		U Single Door 18"
	C 60"		E Double Door 30"
	D 66"		F Double Door 36"
	E 72"		G Removable Access Panel
	F 78"		H Finished Modesty Panel
	G 84"		J Open - No Modesty Panel
	H 90"		K End Panel - Finished
	J 96"		L Recessed End Panel Unfinished
	K 102"		
	L 108"		
	T 114"		
	U 120"		

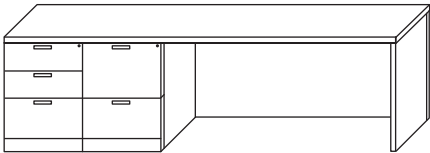

OW 90"
OD 24"
OH 29"

Note: Fairmont units have two (2) pulls per lateral file drawer (Components C and D)

Style Number Descriptions

Product Code: Denotes the product as a credenza and also specifies the number of credenza finished sides.

31 - 1 Side: Only the front (user side) is finished. These units have unfinished backs.

32 - 2 Sides: Front and one end is finished. Credenza back is unfinished.

33 - 3 Sides: Front and both ends are finished. Credenza back is unfinished.

34 - 4 Sides: Front, back and both ends are finished. Credenza back is finished.

Fairmont: Edge detail each finished side, no overhang.



Finished - 1 Side (**31**)

Actual Depth = 24"

Unfinished Back



Finished - 2 Sides (**32**)

Actual Depth = 24"

Unfinished Back



Finished - 3 Sides (**33**)

Actual Depth = 24"

Unfinished Back



Finished - 4 Sides (**34**)

Actual Depth = 24 3/4"

Note: Additional 3/4" added to depth for Product Code 34

Finished Back

Width Code: Denotes the actual width of the credenza.

Note: Credenza pedestal back recessed 4" to allow for wall access and wire management.

HBF Fairmont Casegoods - Credenzas

Credenzas - Other Configurations

Credenza Tops, Descriptions and Pricing

All available sizes of Fairmont credenza tops are listed below. To calculate the price of a credenza, total the individual prices of all components and the credenza top price. Individual component prices are contained in the lists below. All credenza tops with an edge detail on the front (user side) profile are Product Code 31. Credenza tops with edge details on the front (user side) and back profiles, Product Code 34, include a finished back panel. Pricing examples are calculated on the following page.

Credenza Top Width	Width Code	Credenza Top List Price			Weight	Product Code 34 Credenzas			Weight
		Product Code 31, 32, 33 Credenzas	Veneer 1	Veneer 2		Veneer 3	Veneer 1	Veneer 2	
18"	M	386	417	464	35	984	1062	1180	62
24"	N	422	456	507	45	1020	1101	1224	75
30"	P	525	567	630	55	1123	1213	1347	88
36"	R	567	612	680	65	1174	1268	1409	101
42"	S	618	667	742	78	1221	1318	1465	114
48"	A	664	717	797	85	1267	1368	1520	127
54"	B	937	1012	1125	95	1622	1752	1947	140
60"	C	973	1051	1168	105	1663	1797	1996	153
66"	D	1015	1096	1217	115	1700	1835	2039	166
72"	E	1056	1140	1267	125	1741	1880	2089	179
78"	F	1200	1296	1440	135	2086	2253	2503	193
84"	G	1246	1346	1496	143	2132	2303	2559	205
90"	H	1303	1407	1564	153	2281	2464	2738	219
96"	J	1349	1457	1619	163	2328	2514	2793	233
102"	K	1375	1485	1650	173	2549	2753	3059	248
108"	L	1396	1507	1675	183	2575	2781	3090	263
114"	T	1473	1591	1767	193	2714	2931	3257	278
120"	U	1494	1613	1792	203	2750	2970	3300	293

Credenza Components, Descriptions and Pricing

Component Configuration: Denotes the pedestal/component configuration when viewing the credenza from the user side and reading left to right. When selecting from the following components please ensure the width of credenza top specified will accommodate all selected components. Kneespaces will account for the difference between credenza overall width and the total width of all specified components coded A, B, C, D, U, E and F. Minimum kneespace width should be at least 24".

Casegood Components	Component Code	OW	List Price			Weight
			Veneer 1	Veneer 2	Veneer 3	
Box/box/file	A	18"	1334	1441	1601	125
File/file	B	18"	1334	1441	1601	125
Lateral file	C	30"	1602	1730	1922	140
Lateral file	D	36"	1694	1830	2033	140
Lat/Open	M	30"	1447	1563	1737	85
Lat/Open	N	36"	1540	1663	1848	95
Single door cabinet*	U	18"	1097	1185	1316	95
Double door cabinet	E	30"	1360	1468	1632	95
Double door cabinet	F	36"	1385	1496	1662	95
Removable access panel	G	6" - 30"	335	362	402	24
		31" - 60"	397	428	476	42
		61" (2 panels)	721	779	865	60

Note: Fairmont units have two (2) pulls per lateral file drawer (Components C and D)

This kneespace panel is completely removable to allow for wall access. It has a standard black unfinished back and is finished inside. The width will vary based upon credenza top width selected and the width of all specified components. The removable access panel price is based on its width. Only specified for Product Code 31, 32, 33.

Finished modesty panel	H	varies	No Charge (Product Code 34)	N/A
<i>The panel is fixed and is finished on both sides. This kneespace panel is standard on all kneespace credenzas with edge details on the front and back profiles (Product Code 34). Its size will be automatically selected. There is no charge for a finished modesty panel as its cost is contained in the pricing above for credenza tops with front and back edge details. Only specified for Product Code 34.</i>				
Open back	J	varies	No Charge	N/A
<i>No removable access panel or finished modesty panel will be placed in the back of the kneespace.</i>				

Note: *1. Specify left hinge or right hinge on single door cabinets.

HBF Fairmont Casegoods - Credenzas

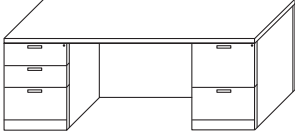

Credenzas Pricing Examples

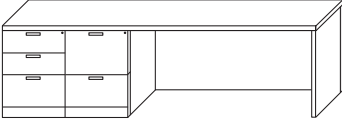
	Component Description	Width Code	Component Code	List Price	
FA33E-AGB 	72" Top	E		\$1267	
	Box/box/file		A	\$1601	
	36" Removable access panel - unfinished back		G	\$476	
	File/file		B	\$1601	
	Total			\$4945	Veneer Grade 3

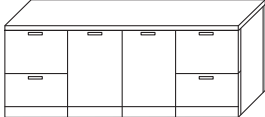
FA33H-ABG 	90" Top	H		\$1407	
	Box/box/file		A	\$1441	
	File/file		B	\$1441	
	54" Removable access panel - unfinished back		G	\$428	
	Total			\$4717	Veneer Grade 2

FA34D-BEB 	66" Top (finished back panel)	D		\$1700	
	File/file		B	\$1334	
	Double door cabinet - 30"		E	\$1360	
	File/file		B	\$1334	
	Total			\$5728	Veneer Grade 1

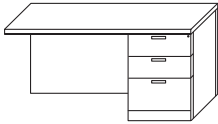
HBF Fairmont Casegoods - Returns

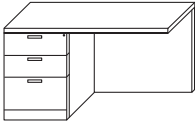
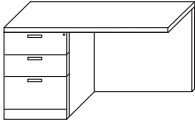
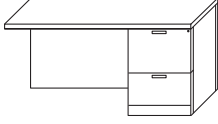
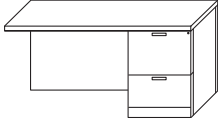
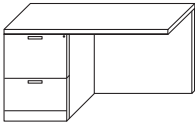
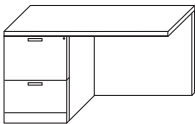
	Style Number	List Price			Dimensions			Weight
		Veneer 1	Veneer 2	Veneer 3	OW	OD	OH	
Returns with Pedestals								
	FA44S-HA	2544	2759	3065	42	24	29	254
	FA44A-HA	2601	2809	3121	48	24	29	266
	FA44B-HA	2956	3193	3547	54	24	29	278
Veneer species must be noted on each line item								
Finished, fixed modesty panel.								
	FA43S-GA	2287	2470	2744	42	24	29	249
	FA43A-GA	2333	2520	2800	48	24	29	262
	FA43B-GA	2668	2881	3201	54	24	29	274
Veneer species must be noted on each line item								
Removable access panel with unfinished back.								
	FA44S-AH	2544	2759	3065	42	24	29	254
	FA44A-AH	2601	2809	3121	48	24	29	266
	FA44B-AH	2956	3193	3547	54	24	29	278
Veneer species must be noted on each line item								
Finished, fixed modesty panel.								
	FA43S-AG	2287	2470	2744	42	24	29	249
	FA43A-AG	2333	2520	2800	48	24	29	262
	FA43B-AG	2668	2881	3201	54	24	29	274
Veneer species must be noted on each line item								
Removable access panel with unfinished back.								
	FA44S-HB	2544	2759	3065	42	24	29	254
	FA44A-HB	2601	2809	3121	48	24	29	266
	FA44B-HB	2956	3193	3547	54	24	29	278
Veneer species must be noted on each line item								
Finished, fixed modesty panel.								
	FA43S-GB	2287	2470	2744	42	24	29	249
	FA43A-GB	2333	2520	2800	48	24	29	262
	FA43B-GB	2668	2881	3201	54	24	29	274
Veneer species must be noted on each line item								
Removable access panel with unfinished back.								
	FA44S-BH	2544	2759	3065	42	24	29	254
	FA44A-BH	2601	2809	3121	48	24	29	266
	FA44B-BH	2956	3193	3547	54	24	29	278
Veneer species must be noted on each line item								
Finished, fixed modesty panel.								
	FA43S-BG	2287	2470	2744	42	24	29	249
	FA43A-BG	2333	2520	2800	48	24	29	262
	FA43B-BG	2668	2881	3201	54	24	29	274
Veneer species must be noted on each line item								
Removable access panel with unfinished back.								
Veneer species must be noted on each line item								
<u>Veneer Grade 1</u>			<u>Veneer Grade 2</u>			<u>Veneer Grade 3</u>		
Cherry			Rift Oak			Anigre		
Maple			Sapele					
Ligno-Grain								
Walnut								

HBF Fairmont Casegoods - Returns

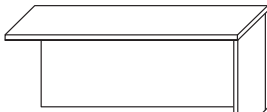
	Style Number	List Price			Dimensions			Weight
		Veneer 1	Veneer 2	Veneer 3	OW	OD	OH	
	FA44C-HK	2039	2203	2447	60	24	29	282
	FA44D-HK	2075	2241	2491	66	24	29	296
	FA44E-HK	2117	2286	2540	72	24	29	309
	FA44F-HK	2462	2659	2954	78	24	29	322
	FA44G-HK	2508	2709	3010	84	24	29	335

Veneer species must be noted on each line item

Finished, fixed modesty panel.

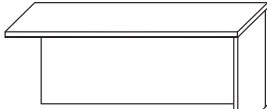
	FA43C-GK	1746	1886	2095	60	24	29	282
	FA43D-GK	2112	2280	2534	66	24	29	296
	FA43E-GK	2153	2325	2583	72	24	29	309
	FA43F-GK	2297	2481	2756	78	24	29	322
	FA43G-GK	2343	2531	2812	84	24	29	335

Veneer species must be noted on each line item

Removable access panel with unfinished back.

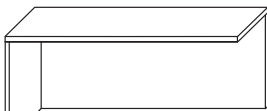
	FA44C-KH	2039	2203	2447	60	24	29	282
	FA44D-KH	2075	2241	2491	66	24	29	296
	FA44E-KH	2117	2286	2540	72	24	29	309
	FA44F-KH	2462	2659	2954	78	24	29	322
	FA44G-KH	2508	2709	3010	84	24	29	335

Veneer species must be noted on each line item

Finished, fixed modesty panel.

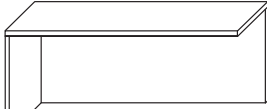
	FA43C-KG	1746	1886	2095	60	24	29	282
	FA43D-KG	2112	2280	2534	66	24	29	296
	FA43E-KG	2153	2325	2583	72	24	29	309
	FA43F-KG	2297	2481	2756	78	24	29	322
	FA43G-KG	2343	2531	2812	84	24	29	335

Veneer species must be noted on each line item

Removable access panel with unfinished back.

Veneer species must be noted on each line item

Veneer Grade 1	Veneer Grade 2	Veneer Grade 3
Cherry	Rift Oak	Anigre
Maple	Sapele	
Ligno-Grain		
Walnut		

HBF Fairmont Casegoods - Returns

Returns - Other Configurations

HBF Fairmont returns are offered in many different sizes and pedestal configurations for maximum flexibility. For ease in specification, use the style number creation system described below. This system allows you to select a variety of return widths and place components in any configuration. Return pricing is calculated by totaling the individual prices of all components and the return top price. *Several commonly used returns are listed on the previous pages for your convenience.*

Style Number Creation System

Example Return

Product Code	Width Code	=	Component Configuration
43 ↓	H ↓		ABG ↓
43 Return - Front and one end finished	M 18"		A Box/Box/File 18"
44 Return - Front, back and one end finished	N 24"		B File/File 18"
	P 30"		C Lateral File 30"
	R 36"		D Lateral File 36"
	S 42"		M Open Lateral File 30"
	A 48"		N Open Lateral File 36"
	B 54"		U Single Door 18"
	C 60"		E Double Door 30"
	D 66"		F Double Door 36"
	E 72"		G Removable Access Panel
	F 78"		H Finished Modesty Panel
	G 84"		J Open - No Modesty Panel
	H 90"		K End Panel - Finished
	J 96"		L Recessed End Panel Unfinished
	K 102"		
	L 108"		
	T 114"		
	U 120"		

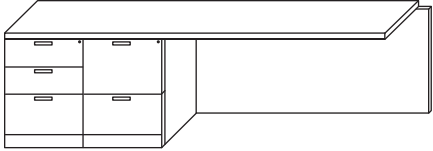

OW 90"
OD 24"
OH 29"

Style Number Descriptions

Product Code: Denotes the product as a return and also specifies the number of return finished sides.

43 - 2 Sides: Front and one end finished. Return back is unfinished.

44 - 3 Sides: Front, back and one end finished. Return back is finished.

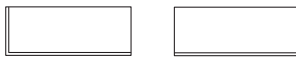

Finished - 2 Sides (**43**)

Actual Depth = 24"

Unfinished Back



Finished - 3 Sides (**44**)

Actual Depth = 24 3/4"

Finished Back

Width Code: Denotes the actual width of the return.

Note: Return pedestal back recessed 4" to allow for wall access and wire management.

HBF Fairmont Casegoods - Returns

Returns - Other Configurations

Return Tops, Descriptions and Pricing

All available sizes of Fairmont return tops are listed below. To calculate the price of a return, total the individual prices of all components and the return top price. Individual component prices are contained in the lists below. All return tops with Product Code 43 have an unfinished back. Return tops with a Product Code 44, *include a finished back panel.*

Return Top Width	Width Code	Return Top List Price			Weight	Product Code 44 Returns			Weight
		Product Code 43 Returns				Product Code 44 Returns			
		Veneer 1	Veneer 2	Veneer 3		Veneer 1	Veneer 2	Veneer 3	
18"	M	386	417	464	35	984	1062	1180	62
24"	N	422	456	507	45	1020	1101	1224	75
30"	P	525	567	630	55	1123	1213	1347	88
36"	R	567	612	680	65	1174	1268	1409	101
42"	S	618	667	742	78	1221	1318	1465	114
48"	A	664	717	797	85	1267	1368	1520	127
54"	B	937	1012	1125	95	1622	1752	1947	140
60"	C	973	1051	1168	105	1663	1797	1996	153
66"	D	1015	1096	1217	115	1700	1835	2039	166
72"	E	1056	1140	1267	125	1741	1880	2089	179
78"	F	1200	1296	1440	135	2086	2253	2503	193
84"	G	1246	1346	1496	143	2132	2303	2559	205
90"	H	1303	1407	1564	153	2281	2464	2738	219
96"	J	1349	1457	1619	163	2328	2514	2793	233
102"	K	1375	1485	1650	173	2549	2753	3059	248
108"	L	1396	1507	1675	183	2575	2781	3090	263
114"	T	1473	1591	1767	193	2714	2931	3257	278
120"	U	1494	1613	1792	203	2750	2970	3300	293

Return Components, Descriptions and Pricing

Component Configuration: Denotes the pedestal/component configuration when viewing the return from the user side and reading left to right. When selecting from the following components please ensure the width of return top specified will accommodate all selected components. Kneespaces will account for the difference between return overall width and the total width of all specified components coded A, B, C, D, U, E and F. Minimum kneespace width should be at least 24".

Casegood Components	Component Code	OW	List Price			Weight
			Veneer 1	Veneer 2	Veneer 3	
Box/box/file	A	18"	1334	1441	1601	125
File/file	B	18"	1334	1441	1601	125
Lateral file	C	30"	1602	1730	1922	140
Lateral file	D	36"	1694	1830	2033	140
Lat/Open	M	30"	1447	1563	1737	85
Lat/Open	N	36"	1540	1663	1848	95
Single door cabinet*	U	18"	1097	1185	1316	95
Double door cabinet	E	30"	1360	1468	1632	95
Double door cabinet	F	36"	1385	1496	1662	95
Removable access panel	G	6" - 30"	335	362	402	24
		31" - 60"	397	428	476	42
		61" (2 panels)	721	779	865	60

This kneespace panel is completely removable to allow for wall access. It has a standard black unfinished back and is finished inside. The width will vary based upon return top width selected and the width of all specified components. The removable access panel price is based on its width. Only specified for Product Code 31, 32, 33.

Finished modesty panel	H	varies	No Charge (Product Code 44)	N/A
<i>The panel is fixed and is finished on both sides. This kneespace panel is standard on all kneespace return with edge details on the front and back profiles (Product Code 44). Its size will be automatically selected. There is no charge for a finished modesty panel as its cost is contained in the pricing above for return tops with front and back edge details. Only specified for Product Code 44.</i>				
Open back	J	varies	No Charge	N/A
<i>No removable access panel or finished modesty panel will be placed in the back of the kneespace.</i>				

Note: *1. Specify left hinge or right hinge on single door cabinets.

HBF Fairmont Casegoods - Bridges, Corner Units

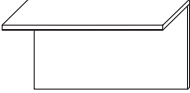
	Style Number	List Price			Dimensions			Weight
		Veneer 1	Veneer 2	Veneer 3	OW	OD	OH	
	FA52D	1200	1296	1440	24	24	29	111
	FA52E	1282	1385	1539	30	24	29	123
	FA52F	1324	1429	1588	36	24	29	135
	FA52A	1375	1485	1650	42	24	29	147
	FA52B	1416	1530	1700	48	24	29	159
	FA52C	1663	1797	1996	54	24	29	171

Veneer species must be noted on each line item

Finished, fixed modesty panel.

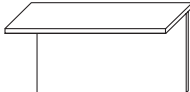
	FA51D	870	940	1044	24	24	29	101
	FA51E	942	1018	1131	30	24	29	113
	FA51F	994	1073	1193	36	24	29	125
	FA51A	1045	1129	1255	42	24	29	137
	FA51B	1087	1174	1304	48	24	29	149
	FA51C	1416	1530	1700	54	24	29	161

Veneer species must be noted on each line item

Removable access panel; standard black, unfinished back.

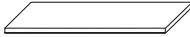
	FA50D	438	473	525	24	24		68
	FA50E	530	573	637	30	24		80
	FA50F	572	617	686	36	24		92
	FA50A	623	673	748	42	24		104
	FA50B	664	717	797	48	24		116
	FA50C	984	1062	1180	54	24		128

Veneer species must be noted on each line item

Bridge top only.

24", 30" and 36" OW bridges are to be used only with corner units. Only bridges 42" OW and greater can be used with u-shaped configurations.

Veneer species must be noted on each line item

<u>Veneer Grade 1</u>	<u>Veneer Grade 2</u>	<u>Veneer Grade 3</u>
Cherry	Rift Oak	Anigre
Maple	Sapele	
Ligno-Grain		
Walnut		

HBF Fairmont Casegoods - Bridges, Corner Units

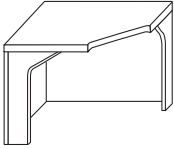
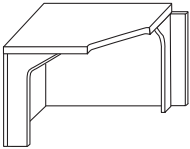
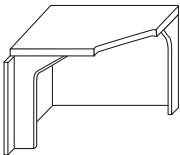
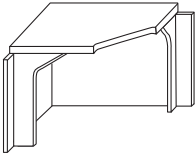
Style Number	List Price			Dimensions			Weight	
	Veneer 1	Veneer 2	Veneer 3	OW	OD	OH		
Corner Units								
	FA55A	3188	3443	3825	42	42	29	147
	FA55B	3239	3498	3887	48	48	29	159
Veneer species must be noted on each line item								
Finished, fixed modesty panel left and right.								
	FA56CL	2766	2987	3319	42	42	29	137
	FA56DL	2817	3042	3380	48	48	29	149
Veneer species must be noted on each line item								
Finished, fixed modesty panel left, removable access panel right.								
	FA56CR	2766	2987	3319	42	42	29	137
	FA56DR	2817	3042	3380	48	48	29	149
Veneer species must be noted on each line item								
Removable access panel left, finished fixed modesty panel right.								
	FA56A	2498	2698	2997	42	42	29	137
	FA56B	2549	2753	3059	48	48	29	149
Veneer species must be noted on each line item								
Removable access panels left and right.								

Corner units used with bridges or returns only.

24", 30" and 36" OW bridges are to be used only with corner units. Only bridges 42" OW and greater can be used with u-shaped configurations.

Veneer species must be noted on each line item

<u>Veneer Grade 1</u>	<u>Veneer Grade 2</u>	<u>Veneer Grade 3</u>
Cherry	Rift Oak	Anigre
Maple	Sapele	
Ligno-Grain		
Walnut		

HBF Fairmont Casegoods - Desk Extensions

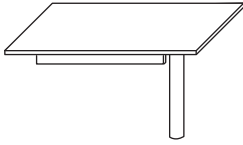
Style Number	List Price			Dimensions			Weight	
	Veneer 1	Veneer 2	Veneer 3	OW	OD	OH		
Desk Extensions								
	FA20A	1839	1986	2206	48	30	29	156
	FA20B	1942	2097	2330	48	36	29	175
	FA20C	1890	2041	2268	54	30	29	174
	FA20D	1983	2141	2379	54	36	29	196
	FA20E	1942	2097	2330	60	30	29	191
	FA20F	2034	2197	2441	60	36	29	226
	FA20G	1983	2141	2379	66	30	29	206
	FA20H	2075	2241	2491	66	36	29	254
	FA20J	2034	2197	2441	72	30	29	222
	FA20K	2117	2286	2540	72	36	29	281

Veneer species must be noted on each line item

Rectangular, end forms joint with the profile of worksurface to which it is connected. Metal base support available in satin nickel or black powder coat finish, please specify on order.

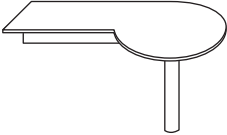
	FA22C	2642	2853	3170	54	30/36	29	196
	FA22D	2786	3009	3343	54	36/42	29	229
	FA22E	2724	2942	3269	60	30/36	29	226
	FA22F	2848	3076	3418	60	36/42	29	254
	FA22G	2786	3009	3343	66	30/36	29	254
	FA22H	2920	3154	3504	66	36/42	29	278
	FA22J	2848	3076	3418	72	30/36	29	281
	FA22K	2982	3220	3578	72	36/42	29	298

Veneer species must be noted on each line item

"P" left hand, end forms joint with the profile of worksurface to which it is connected. Metal base support available in satin nickel or black powder coat finish, please specify on order.

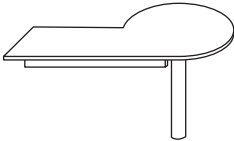
	FA23C	2642	2853	3170	54	30/36	29	196
	FA23D	2786	3009	3343	54	36/42	29	229
	FA23E	2724	2942	3269	60	30/36	29	226
	FA23F	2848	3076	3418	60	36/42	29	254
	FA23G	2786	3009	3343	66	30/36	29	254
	FA23H	2920	3154	3504	66	36/42	29	278
	FA23J	2848	3076	3418	72	30/36	29	281
	FA23K	2982	3220	3578	72	36/42	29	298

Veneer species must be noted on each line item

"P" right hand, end forms joint with the profile of worksurface to which it is connected. Metal base support available in satin nickel or black powder coat finish, please specify on order.

Veneer species must be noted on each line item

Veneer Grade 1	Veneer Grade 2	Veneer Grade 3
Cherry	Rift Oak	Anigre
Maple	Sapele	
Ligno-Grain		
Walnut		

HBF Fairmont Casegoods - Desk Extensions

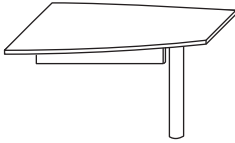
Style Number	List Price			Dimensions			Weight	
	Veneer 1	Veneer 2	Veneer 3	OW	OD	OH		
Desk Extensions								
	FA24A	2220	2397	2664	48	24/30	29	156
	FA24B	2312	2497	2775	48	30/36	29	175
	FA24C	2271	2453	2725	54	24/30	29	174
	FA24D	2364	2553	2837	54	30/36	29	196
	FA24E	2312	2497	2775	60	24/30	29	191
	FA24F	2405	2597	2886	60	30/36	29	226
	FA24G	2364	2553	2837	66	24/30	29	206
	FA24H	2457	2653	2948	66	30/36	29	254
	FA24J	2405	2597	2886	72	24/30	29	222
	FA24K	2498	2698	2997	72	30/36	29	281

Veneer species must be noted on each line item

Half boat, end forms joint with the profile of worksurface to which it is connected. Metal base support available in satin nickel or black powder coat finish, please specify on order.

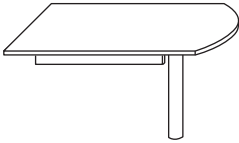
	FA25A	2106	2275	2528	48	30	29	156
	FA25B	2199	2375	2639	48	36	29	175
	FA25C	2158	2330	2589	54	30	29	174
	FA25D	2240	2419	2688	54	36	29	196
	FA25E	2199	2375	2639	60	30	29	191
	FA25F	2292	2475	2750	60	36	29	226
	FA25G	2240	2419	2688	66	30	29	206
	FA25H	2333	2520	2800	66	36	29	254
	FA25J	2281	2464	2738	72	30	29	222
	FA25K	2374	2564	2849	72	36	29	281

Veneer species must be noted on each line item

Arç'd end, end forms joint with the profile of worksurface to which it is connected. Metal base support available in satin nickel or black powder coat finish, please specify on order.

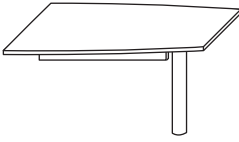
	FA26A	2106	2275	2528	48	27/30	29	156
	FA26B	2199	2375	2639	48	33/36	29	175
	FA26C	2158	2330	2589	54	27/30	29	174
	FA26D	2240	2419	2688	54	33/36	29	196
	FA26E	2199	2375	2639	60	27/30	29	191
	FA26F	2292	2475	2750	60	33/36	29	226
	FA26G	2240	2419	2688	66	27/30	29	206
	FA26H	2333	2520	2800	66	33/36	29	254
	FA26J	2281	2464	2738	72	27/30	29	222
	FA26K	2374	2564	2849	72	33/36	29	281

Veneer species must be noted on each line item

Quarter boat left hand, end forms joint with the profile of worksurface to which it is connected. Metal base support available in satin nickel or black powder coat finish, please specify on order.

Veneer species must be noted on each line item

<u>Veneer Grade 1</u>	<u>Veneer Grade 2</u>	<u>Veneer Grade 3</u>
Cherry	Rift Oak	Anigre
Maple	Sapele	
Ligno-Grain		
Walnut		

HBF Fairmont Casegoods - Desk Extensions

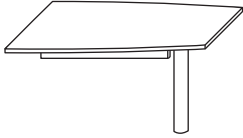
Style Number	List Price			Dimensions			Weight	
	Veneer 1	Veneer 2	Veneer 3	OW	OD	OH		
Desk Extensions								
	FA27A	2106	2275	2528	48	27/30	29	156
	FA27B	2199	2375	2639	48	33/36	29	175
	FA27C	2158	2330	2589	54	27/30	29	174
	FA27D	2240	2419	2688	54	33/36	29	196
	FA27E	2199	2375	2639	60	27/30	29	191
	FA27F	2292	2475	2750	60	33/36	29	226
	FA27G	2240	2419	2688	66	27/30	29	206
	FA27H	2333	2520	2800	66	33/36	29	254
	FA27J	2281	2464	2738	72	27/30	29	222
	FA27K	2374	2564	2849	72	33/36	29	281

Veneer species must be noted on each line item

Quarter boat right hand, end forms joint with the profile of worksurface to which it is connected. Metal base support available in satin nickel or black powder coat finish, please specify on order.

Desk Extensions with end panel

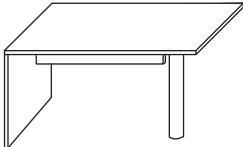
	FA20J-K	2601	2809	3121	72	30	29	251
	FA20K-K	2673	2887	3207	72	36	29	261
	FA20L-K	2642	2853	3170	84	30	29	266
	FA20M-K	2714	2931	3257	84	36	29	271
	FA20N-K	2683	2898	3220	96	30	29	276
	FA20P-K	2755	2976	3306	96	36	29	281

Veneer species must be noted on each line item

Rectangular, metal base support available in satin nickel or black powder coat finish, please specify on order.

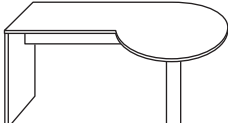
	FA22J-K	3414	3688	4097	72	30/36	29	310
	FA22K-K	3528	3810	4233	72	36/42	29	320
	FA22L-K	3476	3754	4172	84	30/36	29	325
	FA22M-K	3590	3877	4307	84	36/42	29	330
	FA22N-K	3538	3821	4246	96	30/36	29	335
	FA22P-K	3651	3943	4382	96	36/42	29	340

Veneer species must be noted on each line item

"P" left hand, metal base support available in satin nickel or black powder coat finish, please specify on order.

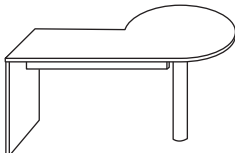
	FA23J-K	3414	3688	4097	72	30/36	29	310
	FA23K-K	3528	3810	4233	72	36/42	29	320
	FA23L-K	3476	3754	4172	84	30/36	29	325
	FA23M-K	3590	3877	4307	84	36/42	29	330
	FA23N-K	3538	3821	4246	96	30/36	29	335
	FA23P-K	3651	3943	4382	96	36/42	29	340

Veneer species must be noted on each line item

"P" right hand, metal base support available in satin nickel or black powder coat finish, please specify on order.

Veneer species must be noted on each line item

Veneer Grade 1	Veneer Grade 2	Veneer Grade 3
Cherry	Rift Oak	Anigre
Maple	Sapele	
Ligno-Grain		
Walnut		

HBF Fairmont Casegoods - Desk Extensions

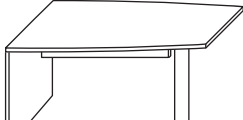
Style Number	List Price			Dimensions			Weight	
	Veneer 1	Veneer 2	Veneer 3	OW	OD	OH		
Desk Extensions with end panel								
	FA24J-K	2972	3209	3566	72	24/30	29	251
	FA24K-K	3054	3298	3665	72	30/36	29	261
	FA24L-K	3013	3254	3615	84	24/30	29	266
	FA24M-K	3095	3343	3715	84	30/36	29	271
	FA24N-K	3054	3298	3665	96	24/30	29	276
	FA24P-K	3136	3387	3764	96	30/36	29	281

Veneer species must be noted on each line item

Half boat, metal base support available in satin nickel or black powder coat finish, please specify on order.

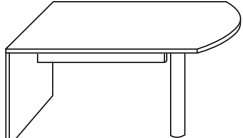
	FA25J-K	2858	3087	3430	72	30	29	251
	FA25K-K	2941	3176	3529	72	36	29	261
	FA25L-K	2899	3131	3479	84	30	29	266
	FA25M-K	2982	3220	3578	84	36	29	271
	FA25N-K	2941	3176	3529	96	30	29	276
	FA25P-K	3020	3262	3624	96	36	29	281

Veneer species must be noted on each line item

Arc'd end, metal base support available in satin nickel or black powder coat finish, please specify on order.

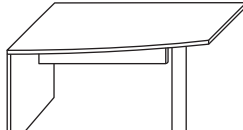
	FA26J-K	2858	3087	3430	72	27/30	29	251
	FA26K-K	2941	3176	3529	72	33/36	29	261
	FA26L-K	2899	3131	3479	84	27/30	29	266
	FA26M-K	2982	3220	3578	84	33/36	29	271
	FA26N-K	2941	3176	3529	96	27/30	29	276
	FA26P-K	3023	3265	3624	96	33/36	29	281

Veneer species must be noted on each line item

Quarter boat left hand, metal base support available in satin nickel or black powder coat finish, please specify on order.

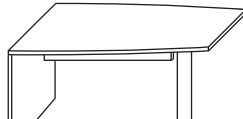
	FA27J-K	2858	3087	3430	72	27/30	29	251
	FA27K-K	2941	3176	3529	72	33/36	29	261
	FA27L-K	2899	3131	3479	84	27/30	29	266
	FA27M-K	2982	3220	3578	84	33/36	29	271
	FA27N-K	2941	3176	3529	96	27/30	29	276
	FA27P-K	3023	3265	3628	96	33/36	29	281

Veneer species must be noted on each line item

Quarter boat right hand, metal base support available in satin nickel or black powder coat finish, please specify on order.

Veneer species must be noted on each line item

Veneer Grade 1	Veneer Grade 2	Veneer Grade 3
Cherry	Rift Oak	Anigre
Maple	Sapele	
Ligno-Grain		
Walnut		

HBF Fairmont Casegoods - Storage Units

Style Number	List Price			Dimensions			Weight
	Veneer 1	Veneer 2	Veneer 3	OW	OD	OH	

Mobile File Pedestal

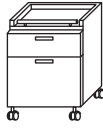

FA30	1746	1886	2095	18	20	24 1/2	147
------	------	------	------	----	----	--------	-----

Veneer species must be noted on each line item

Casters, one box drawer and one file drawer. Metal pull on front to provide ease of movement, face lock. File pedestal will nest under any 29" OH worksurface.

Credenza Storage Towers

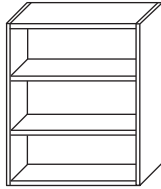
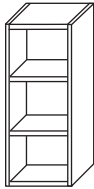

FA68F	1736	1874	2083	18	14 7/8	42 1/4	87
FA68D	2302	2486	2762	30	14 7/8	42 1/4	97
FA68E	2446	2642	2936	36	14 7/8	42 1/4	97

Veneer species must be noted on each line item

Flush top, no profile edge detail, two adjustable shelves, unfinished back, sits on credenza.

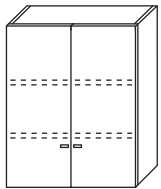
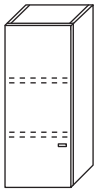

FA69F	2271	2453	2725	18	15 3/4	42 1/4	97
FA69D	2807	3031	3368	30	15 3/4	42 1/4	117
FA69E	2930	3165	3516	36	15 3/4	42 1/4	117

Veneer species must be noted on each line item

Flush top, no profile edge detail, two adjustable shelves, unfinished back, sits on credenza. 18" OW storage towers are one-door units, specify left or right hinge. 30" and 36" OW towers are two-door units.

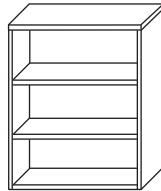
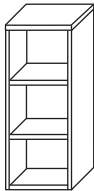

FA68C	1972	2130	2367	18	14 7/8	43 5/8	87
FA68A	2601	2809	3121	30	14 7/8	43 5/8	97
FA68B	2807	3031	3368	36	14 7/8	43 5/8	97

Veneer species must be noted on each line item

Top profile edge detail, two adjustable shelves, unfinished back, sits on credenza.

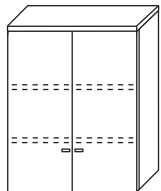
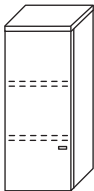

FA69C	2508	2709	3010	18	15 3/4	43 5/8	97
FA69A	3116	3365	3739	30	15 3/4	43 5/8	117
FA69B	3311	3576	3974	36	15 3/4	43 5/8	117

Veneer species must be noted on each line item

Top profile edge detail, two adjustable shelves, unfinished back, sits on credenza. 18" OW storage towers are one-door units, specify left or right hinge. 30" and 36" OW towers are two-door units.

Veneer species must be noted on each line item

Veneer Grade 1	Veneer Grade 2	Veneer Grade 3
Cherry	Rift Oak	Anigre
Maple	Sapele	
Ligno-Grain		
Walnut		

HBF Fairmont Casegoods - Storage Units

Style Number	List Price			Dimensions			Weight
	Veneer 1	Veneer 2	Veneer 3	OW	OD	OH	

Credenza Storage Towers

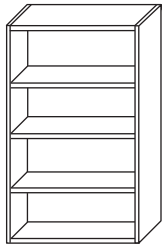
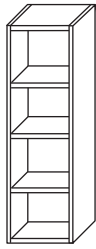

FA68F2	2354	2542	2824	18	14 7/8	56	95
FA68D2	3105	3354	3727	30	14 7/8	56	106
FA68E2	3311	3576	3974	36	14 7/8	56	106

Veneer species must be noted on each line item

Flush top, no profile edge detail, three adjustable shelves, unfinished back, sits on credenza.

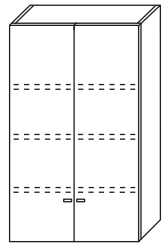
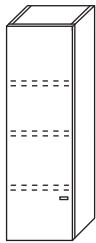

FA69F2	3064	3309	3677	18	15 3/4	56	106
FA69D2	3785	4088	4542	30	15 3/4	56	127
FA69E2	3960	4277	4752	36	15 3/4	56	127

Veneer species must be noted on each line item

Flush top, no profile edge detail, three adjustable shelves, unfinished back, sits on credenza. 18" OW storage towers are one-door units, specify left or right hinge. 30" and 36" OW towers are two-door units.

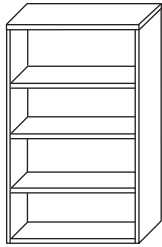
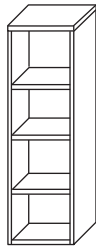

FA68C2	2663	2876	3195	18	14 7/8	57 3/8	95
FA68A2	3517	3799	4221	30	14 7/8	57 3/8	106
FA68B2	3785	4088	4542	36	14 7/8	57 3/8	106

Veneer species must be noted on each line item

Top profile edge detail, three adjustable shelves, unfinished back, sits on credenza.

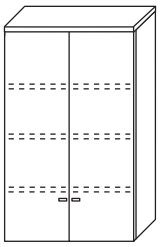
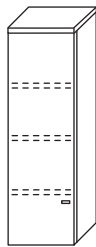

FA69C2	3394	3665	4073	18	15 3/4	57 3/8	106
FA69A2	4208	4544	5049	30	15 3/4	57 3/8	127
FA69B2	4465	4822	5358	36	15 3/4	57 3/8	127

Veneer species must be noted on each line item

Top profile edge detail, three adjustable shelves, unfinished back, sits on credenza. 18" OW storage towers are one-door units, specify left or right hinge. 30" and 36" OW towers are two-door units.

Veneer species must be noted on each line item

<u>Veneer Grade 1</u>	<u>Veneer Grade 2</u>	<u>Veneer Grade 3</u>
Cherry	Rift Oak	Anigre
Maple	Sapele	
Ligno-Grain		
Walnut		

HBF Fairmont Casegoods - Storage Units

Style Number	List Price			Dimensions			Weight
	Veneer 1	Veneer 2	Veneer 3	OW	OD	OH	

Credenza Storage Towers

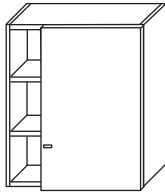

FA69D-P	3085	3332	3702	30	15 3/4	42 1/4	94
FA69E-P	3229	3487	3875	36	15 3/4	42 1/4	114

Veneer species must be noted on each line item

Flush top, no profile edge detail, two adjustable shelves, unfinished back, sits on credenza. All storage towers are one-door units, specify left or right hinge. Open storage area 7 3/4" wide.

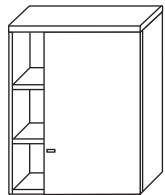

FA69A-P	3425	3699	4110	30	15 3/4	43 5/8	94
FA69B-P	3641	3932	4369	36	15 3/4	43 5/8	114

Veneer species must be noted on each line item

Top profile edge detail, two adjustable shelves, unfinished back, sits on credenza. All storage towers are one-door units, specify left or right hinge. Open storage area 7 3/4" wide.

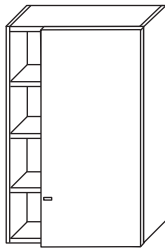

FA69D2-P	4166	4500	5000	30	15 3/4	56	103
FA69E2-P	4362	4711	5234	36	15 3/4	56	125

Veneer species must be noted on each line item

Flush top, no profile edge detail, three adjustable shelves, unfinished back, sits on credenza. All storage towers are one-door units, specify left or right hinge. Open storage area 7 3/4" wide.

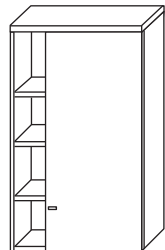

FA69A2-P	4630	5000	5556	30	15 3/4	57 3/8	103
FA69B2-P	4918	5312	5902	36	15 3/4	57 3/8	125

Veneer species must be noted on each line item

Top profile edge detail, three adjustable shelves, unfinished back, sits on credenza. All storage towers are one-door units, specify left or right hinge. Open storage area 7 3/4" wide.

Veneer species must be noted on each line item

<u>Veneer Grade 1</u>	<u>Veneer Grade 2</u>	<u>Veneer Grade 3</u>
Cherry	Rift Oak	Anigre
Maple	Sapele	
Ligno-Grain		
Walnut		

HBF Fairmont Casegoods - Overhead Cabinets

Style Number	Fabric	List Price			Dimensions			Weight
		Veneer 1	Veneer 2	Veneer 3	OW	OD	OH	

Overhead Cabinets, Top without Profile Edge Detail, Wood Panel Support

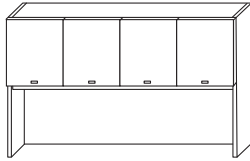

FA62M-FNP	3 yds	3384	3654	4060	72	15 3/4	42 1/4	282
------------------	-------	-------------	-------------	-------------	----	--------	--------	-----

Veneer species must be noted on each line item

Flush top without profile edge detail, fabric tack panel (fabric not included, COM must be acrylic backed), cabinet back unfinished. Optional task lights available, see HBF Casegood Accessories.

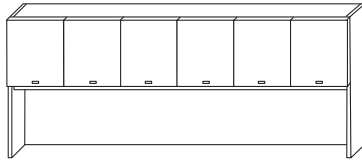

FA62N-FNP	3 yds	3857	4166	4629	78	15 3/4	42 1/4	289
FA62P-FNP	3 yds	4043	4366	4851	84	15 3/4	42 1/4	296
FA62R-FNP	3 yds	4208	4544	5049	90	15 3/4	42 1/4	339
FA62S-FNP	3 1/4 yds	4383	4733	5259	96	15 3/4	42 1/4	351
FA62T-FNP	3 1/2 yds	4568	4933	5482	102	15 3/4	42 1/4	365
FA62U-FNP	3 3/4 yds	4733	5111	5679	108	15 3/4	42 1/4	376
FA62V-FNP	4 1/4 yds	4918	5312	5902	114	15 3/4	42 1/4	391
FA62W-FNP	4 1/4 yds	5104	5512	6124	120	15 3/4	42 1/4	406

Veneer species must be noted on each line item

Flush top without profile edge detail, fabric tack panel (fabric not included, COM must be acrylic backed), cabinet back unfinished. Optional task lights available, see HBF Casegood Accessories.

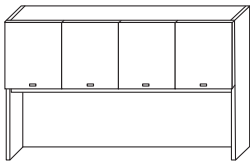

FA63M-FNP		3600	3888	4320	72	15 3/4	42 1/4	282
------------------	--	-------------	-------------	-------------	----	--------	--------	-----

Veneer species must be noted on each line item

Flush top without profile edge detail, finished wood panel, cabinet back unfinished. Optional task lights available, see HBF Casegood Accessories.

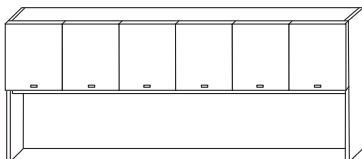

FA63N-FNP		4105	4433	4925	78	15 3/4	42 1/4	289
FA63P-FNP		4300	4644	5160	84	15 3/4	42 1/4	296
FA63R-FNP		4475	4833	5370	90	15 3/4	42 1/4	339
FA63S-FNP		4661	5034	5593	96	15 3/4	42 1/4	351
FA63T-FNP		4860	5248	5831	102	15 3/4	42 1/4	365
FA63U-FNP		5032	5434	6038	108	15 3/4	42 1/4	376
FA63V-FNP		5217	5634	6260	114	15 3/4	42 1/4	391
FA63W-FNP		5402	5835	6483	120	15 3/4	42 1/4	406

Veneer species must be noted on each line item

Flush top without profile edge detail, finished wood panel, cabinet back unfinished. Optional task lights available, see HBF Casegood Accessories.

Veneer species must be noted on each line item

<u>Veneer Grade 1</u>	<u>Veneer Grade 2</u>	<u>Veneer Grade 3</u>
Cherry	Rift Oak	Anigre
Maple	Sapele	
Ligno-Grain		
Walnut		

HBF Fairmont Casegoods - Overhead Cabinets

Style Number	Fabric	List Price			Dimensions			Weight
		Veneer 1	Veneer 2	Veneer 3	OW	OD	OH	

Overhead Cabinets, Top without Profile Edge Detail, Wood Panel Support

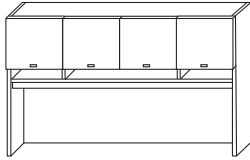

FA62M-FWP	3 yds	3723	4021	4468	72	15 3/4	42 1/4	282
------------------	-------	-------------	-------------	-------------	----	--------	--------	-----

Veneer species must be noted on each line item

Flush top without profile edge detail, fabric tack panel (fabric not included, COM must be acrylic backed). Open project shelf storage 3" high. Cabinet back unfinished. Optional task lights available, see HBF Casegood Accessories.

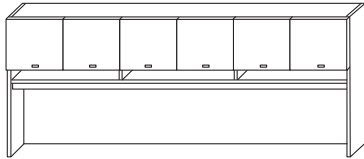

FA62N-FWP	3 yds	4249	4589	5099	78	15 3/4	42 1/4	289
FA62P-FWP	3 yds	4444	4800	5333	84	15 3/4	42 1/4	296
FA62R-FWP	3 yds	4630	5000	5556	90	15 3/4	42 1/4	339
FA62S-FWP	3 1/4 yds	4826	5212	5791	96	15 3/4	42 1/4	351
FA62T-FWP	3 1/2 yds	5021	5423	6026	102	15 3/4	42 1/4	365
FA62U-FWP	3 3/4 yds	5207	5623	6248	108	15 3/4	42 1/4	376
FA62V-FWP	4 1/4 yds	5392	5823	6470	114	15 3/4	42 1/4	391
FA62W-FWP	4 1/4 yds	5577	6024	6693	120	15 3/4	42 1/4	406

Veneer species must be noted on each line item

Flush top without profile edge detail, fabric tack panel (fabric not included, COM must be acrylic backed). Open project shelf storage 3" high. Cabinet back unfinished. Optional task lights available, see HBF Casegood Accessories.

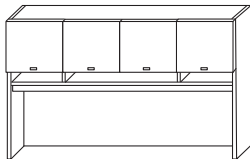

FA63M-FWP		3960	4277	4752	72	15 3/4	42 1/4	282
------------------	--	-------------	-------------	-------------	----	--------	--------	-----

Veneer species must be noted on each line item

Flush top without profile edge detail, finished wood panel. Open project shelf storage 3" high. Cabinet back unfinished. Optional task lights available, see HBF Casegood Accessories.

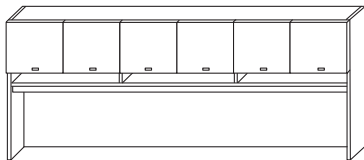

FA63N-FWP		4517	4878	5420	78	15 3/4	42 1/4	289
FA63P-FWP		4733	5111	5679	84	15 3/4	42 1/4	296
FA63R-FWP		4929	5323	5914	90	15 3/4	42 1/4	339
FA63S-FWP		5135	5545	6161	96	15 3/4	42 1/4	351
FA63T-FWP		5351	5779	6421	102	15 3/4	42 1/4	365
FA63U-FWP		5536	5979	6644	108	15 3/4	42 1/4	376
FA63V-FWP		5722	6179	6866	114	15 3/4	42 1/4	391
FA63W-FWP		5907	6380	7088	120	15 3/4	42 1/4	406

Veneer species must be noted on each line item

Flush top without profile edge detail, finished wood panel. Open project shelf storage 3" high. Cabinet back unfinished. Optional task lights available, see HBF Casegood Accessories.

Veneer species must be noted on each line item

<u>Veneer Grade 1</u>	<u>Veneer Grade 2</u>	<u>Veneer Grade 3</u>
Cherry	Rift Oak	Anigre
Maple	Sapele	
Ligno-Grain		
Walnut		

HBF Fairmont Casegoods - Overhead Cabinets

Style Number	Fabric	List Price			Dimensions			Weight
		Veneer 1	Veneer 2	Veneer 3	OW	OD	OH	

Overhead Cabinets, Top without Profile Edge Detail, Wood Panel Support

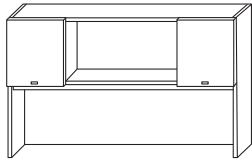

FA62M-PNP	3 yds	3208	3465	3850	72	15 3/4	42 1/4	282
------------------	-------	-------------	-------------	-------------	----	--------	--------	-----

Veneer species must be noted on each line item

Flush top without profile edge detail, fabric tack panel (fabric not included, COM must be acrylic backed). Open center storage. Cabinet back unfinished. Optional task lights available, see HBF Casegood Accessories.

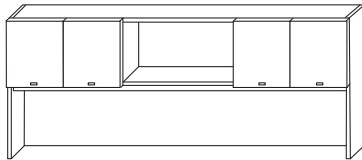

FA62N-PNP	3 yds	3672	3966	4406	78	15 3/4	42 1/4	289
FA62P-PNP	3 yds	3837	4144	4604	84	15 3/4	42 1/4	296
FA62R-PNP	3 yds	4002	4322	4802	90	15 3/4	42 1/4	339
FA62S-PNP	3 1/4 yds	4166	4500	5000	96	15 3/4	42 1/4	351
FA62T-PNP	3 1/2 yds	4331	4678	5197	102	15 3/4	42 1/4	365
FA62U-PNP	3 3/4 yds	4496	4856	5395	108	15 3/4	42 1/4	376
FA62V-PNP	4 1/4 yds	4681	5056	5618	114	15 3/4	42 1/4	391
FA62W-PNP	4 1/4 yds	4867	5256	5840	120	15 3/4	42 1/4	406

Veneer species must be noted on each line item

Flush top without profile edge detail, fabric tack panel (fabric not included, COM must be acrylic backed). Open center storage. Cabinet back unfinished. Optional task lights available, see HBF Casegood Accessories.

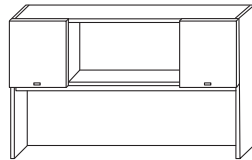

FA63M-PNP		3425	3699	4110	72	15 3/4	42 1/4	282
------------------	--	-------------	-------------	-------------	----	--------	--------	-----

Veneer species must be noted on each line item

Flush top without profile edge detail, finished wood panel. Open center storage. Cabinet back unfinished. Optional task lights available, see HBF Casegood Accessories.

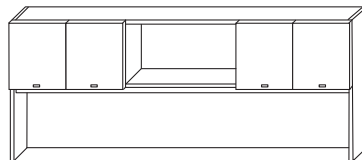

FA63N-PNP		3899	4210	4678	78	15 3/4	42 1/4	289
FA63P-PNP		4084	4411	4901	84	15 3/4	42 1/4	296
FA63R-PNP		4249	4589	5099	90	15 3/4	42 1/4	339
FA63S-PNP		4434	4789	5321	96	15 3/4	42 1/4	351
FA63T-PNP		4620	4989	5543	102	15 3/4	42 1/4	365
FA63U-PNP		4784	5167	5741	108	15 3/4	42 1/4	376
FA63V-PNP		4970	5367	5964	114	15 3/4	42 1/4	391
FA63W-PNP		5155	5568	6186	120	15 3/4	42 1/4	406

Veneer species must be noted on each line item

Flush top without profile edge detail, finished wood panel. Open center storage. Cabinet back unfinished. Optional task lights available, see HBF Casegood Accessories.

Veneer species must be noted on each line item

<u>Veneer Grade 1</u>	<u>Veneer Grade 2</u>	<u>Veneer Grade 3</u>
Cherry	Rift Oak	Anigre
Maple	Sapele	
Ligno-Grain		
Walnut		

HBF Fairmont Casegoods - Overhead Cabinets

Style Number	Fabric	List Price			Dimensions			Weight
		Veneer 1	Veneer 2	Veneer 3	OW	OD	OH	

Overhead Cabinets, Top without Profile Edge Detail, Wood Panel Support

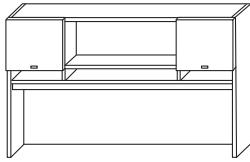

FA62M-PWP	3 yds	3548	3832	4258	72	15 3/4	42 1/4	282
------------------	-------	-------------	-------------	-------------	----	--------	--------	-----

Veneer species must be noted on each line item

Flush top without profile edge detail, fabric tack panel (fabric not included, COM must be acrylic backed). Open project shelf storage 3" high and open center storage. Cabinet back unfinished. Optional task lights available, see HBF Casegood Accessories.

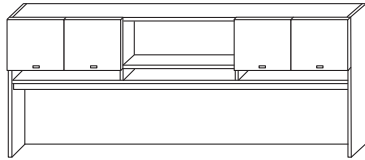

FA62N-PWP	3 yds	4053	4377	4864	78	15 3/4	42 1/4	289
FA62P-PWP	3 yds	4249	4589	5099	84	15 3/4	42 1/4	296
FA62R-PWP	3 yds	4424	4778	5309	90	15 3/4	42 1/4	339
FA62S-PWP	3 1/4 yds	4599	4967	5519	96	15 3/4	42 1/4	351
FA62T-PWP	3 1/2 yds	4795	5178	5754	102	15 3/4	42 1/4	365
FA62U-PWP	3 3/4 yds	4970	5367	5964	108	15 3/4	42 1/4	376
FA62V-PWP	4 1/4 yds	5155	5568	6186	114	15 3/4	42 1/4	391
FA62W-PWP	4 1/4 yds	5341	5768	6409	120	15 3/4	42 1/4	406

Veneer species must be noted on each line item

Flush top without profile edge detail, fabric tack panel (fabric not included, COM must be acrylic backed). Open project shelf storage 3" high and open center storage. Cabinet back unfinished. Optional task lights available, see HBF Casegood Accessories.

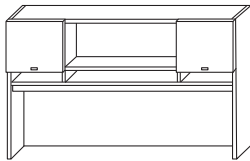

FA63M-PWP		3785	4088	4542	72	15 3/4	42 1/4	282
------------------	--	-------------	-------------	-------------	----	--------	--------	-----

Veneer species must be noted on each line item

Flush top without profile edge detail, finished wood panel. Open project shelf storage 3" high and open center storage. Cabinet back unfinished. Optional task lights available, see HBF Casegood Accessories.

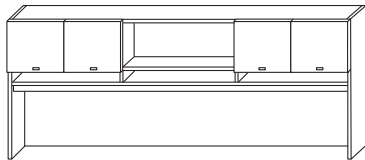

FA63N-PWP		4311	4655	5173	78	15 3/4	42 1/4	289
FA63P-PWP		4517	4878	5420	84	15 3/4	42 1/4	296
FA63R-PWP		4702	5078	5642	90	15 3/4	42 1/4	339
FA63S-PWP		4898	5289	5877	96	15 3/4	42 1/4	351
FA63T-PWP		5104	5512	6124	102	15 3/4	42 1/4	365
FA63U-PWP		5289	5712	6347	108	15 3/4	42 1/4	376
FA63V-PWP		5474	5912	6569	114	15 3/4	42 1/4	391
FA63W-PWP		5660	6113	6792	120	15 3/4	42 1/4	406

Veneer species must be noted on each line item

Flush top without profile edge detail, finished wood panel. Open project shelf storage 3" high and open center storage. Cabinet back unfinished. Optional task lights available, see HBF Casegood Accessories.

Veneer species must be noted on each line item

<u>Veneer Grade 1</u>	<u>Veneer Grade 2</u>	<u>Veneer Grade 3</u>
Cherry	Rift Oak	Anigre
Maple	Sapele	
Ligno-Grain		
Walnut		

HBF Fairmont Casegoods - Overhead Cabinets

Style Number	Fabric	List Price			Dimensions			Weight
		Veneer 1	Veneer 2	Veneer 3	OW	OD	OH	

Overhead Cabinets, Top without Profile Edge Detail, Wood Panel Support (Double High)

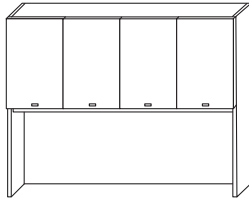

FA62M2-FNP	3 yds	4568	4933	5482	72	15 3/4	56	312
------------	-------	------	------	------	----	--------	----	-----

Veneer species must be noted on each line item

Flush top without profile edge detail, one adjustable shelf, fabric tack panel (fabric not included, COM must be acrylic backed). Cabinet back unfinished. Optional task lights available, see HBF Casegood Accessories.

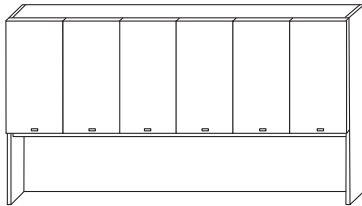

FA62N2-FNP	3 yds	5217	5634	6260	78	15 3/4	56	319
FA62P2-FNP	3 yds	5464	5901	6557	84	15 3/4	56	326
FA62R2-FNP	3 yds	5691	6146	6829	90	15 3/4	56	379
FA62S2-FNP	3 1/4 yds	5928	6402	7113	96	15 3/4	56	391
FA62T2-FNP	3 1/2 yds	6165	6658	7397	102	15 3/4	56	405
FA62U2-FNP	3 3/4 yds	6401	6914	7682	108	15 3/4	56	416
FA62V2-FNP	4 1/4 yds	6638	7169	7966	114	15 3/4	56	441
FA62W2-FNP	4 1/4 yds	6875	7425	8250	120	15 3/4	56	456

Veneer species must be noted on each line item

Flush top without profile edge detail, one adjustable shelf, fabric tack panel (fabric not included, COM must be acrylic backed). Cabinet back unfinished. Optional task lights available, see HBF Casegood Accessories.

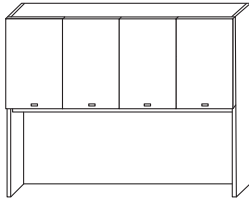

FA63M2-FNP		4867	5256	5840	72	15 3/4	56	312
------------	--	------	------	------	----	--------	----	-----

Veneer species must be noted on each line item

Flush top without profile edge detail, one adjustable shelf, finished wood panel. Cabinet back unfinished. Optional task lights available, see HBF Casegood Accessories.

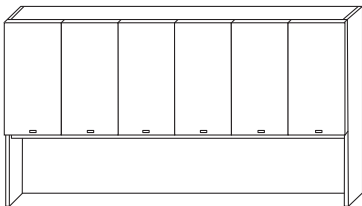

FA63N2-FNP		5547	5990	6656	78	15 3/4	56	319
FA63P2-FNP		5814	6279	6977	84	15 3/4	56	326
FA63R2-FNP		6051	6535	7262	90	15 3/4	56	379
FA63S2-FNP		6298	6802	7558	96	15 3/4	56	391
FA63T2-FNP		6566	7092	7880	102	15 3/4	56	405
FA63U2-FNP		6803	7347	8164	108	15 3/4	56	416
FA63V2-FNP		7040	7603	8448	114	15 3/4	56	441
FA63W2-FNP		7277	7859	8732	120	15 3/4	56	456

Veneer species must be noted on each line item

Flush top without profile edge detail, one adjustable shelf, finished wood panel. Cabinet back unfinished. Optional task lights available, see HBF Casegood Accessories.

Double high overhead cabinets to be used with double high vertical cabinets.

Veneer species must be noted on each line item

Veneer Grade 1	Veneer Grade 2	Veneer Grade 3
Cherry	Rift Oak	Anigre
Maple	Sapele	
Ligno-Grain		
Walnut		

HBF Fairmont Casegoods - Overhead Cabinets

Style Number	Fabric	List Price			Dimensions			Weight
		Veneer 1	Veneer 2	Veneer 3	OW	OD	OH	

Overhead Cabinets, Top without Profile Edge Detail, Wood Panel Support (Double High)

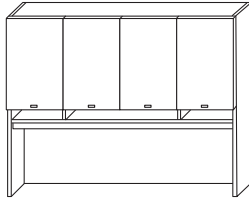

FA62M2-FWP	3 yds	5021	5423	6026	72	15 3/4	56	312
-------------------	-------	-------------	-------------	-------------	----	--------	----	-----

Veneer species must be noted on each line item

Flush top without profile edge detail, one adjustable shelf, fabric tack panel (fabric not included, COM must be acrylic backed). Open project shelf storage 3" high. Cabinet back unfinished. Optional task lights available, see HBF Casegood Accessories.

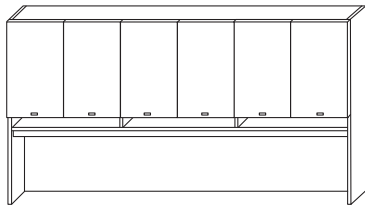

FA62N2-FWP	3 yds	5742	6202	6891	78	15 3/4	56	319
FA62P2-FWP	3 yds	6010	6491	7212	84	15 3/4	56	326
FA62R2-FWP	3 yds	6257	6758	7509	90	15 3/4	56	379
FA62S2-FWP	3 1/4 yds	6515	7036	7818	96	15 3/4	56	391
FA62T2-FWP	3 1/2 yds	6783	7325	8139	102	15 3/4	56	405
FA62U2-FWP	3 3/4 yds	7040	7603	8448	108	15 3/4	56	416
FA62V2-FWP	4 1/4 yds	7277	7859	8732	114	15 3/4	56	441
FA62W2-FWP	4 1/4 yds	7514	8115	9017	120	15 3/4	56	456

Veneer species must be noted on each line item

Flush top without profile edge detail, one adjustable shelf, fabric tack panel (fabric not included, COM must be acrylic backed). Open project shelf storage 3" high. Cabinet back unfinished. Optional task lights available, see HBF Casegood Accessories.

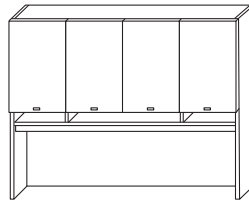

FA63M2-FWP		5351	5779	6421	72	15 3/4	56	312
-------------------	--	-------------	-------------	-------------	----	--------	----	-----

Veneer species must be noted on each line item

Flush top without profile edge detail, one adjustable shelf, finished wood panel. Open project shelf storage 3" high. Cabinet back unfinished. Optional task lights available, see HBF Casegood Accessories.

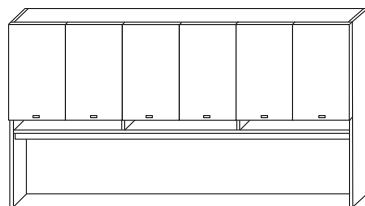

FA63N2-FWP		6103	6591	7323	78	15 3/4	56	319
FA63P2-FWP		6391	6902	7669	84	15 3/4	56	326
FA63R2-FWP		6659	7192	7991	90	15 3/4	56	379
FA63S2-FWP		6927	7481	8312	96	15 3/4	56	391
FA63T2-FWP		7225	7803	8671	102	15 3/4	56	405
FA63U2-FWP		7483	8062	8980	108	15 3/4	56	416
FA63V2-FWP		7720	8337	9264	114	15 3/4	56	441
FA63W2-FWP		7957	8593	9548	120	15 3/4	56	456

Veneer species must be noted on each line item

Flush top without profile edge detail, one adjustable shelf, finished wood panel. Open project shelf storage 3" high. Cabinet back unfinished. Optional task lights available, see HBF Casegood Accessories.

Double high overhead cabinets to be used with double high vertical cabinets.

Veneer species must be noted on each line item

<u>Veneer Grade 1</u>	<u>Veneer Grade 2</u>	<u>Veneer Grade 3</u>
Cherry	Rift Oak	Anigre
Maple	Sapele	
Ligno-Grain		
Walnut		

HBF Fairmont Casegoods - Overhead Cabinets

Style Number	Fabric	List Price			Dimensions			Weight
		Veneer 1	Veneer 2	Veneer 3	OW	OD	OH	

Overhead Cabinets, Top without Profile Edge Detail, Wood Panel Support (Double High)

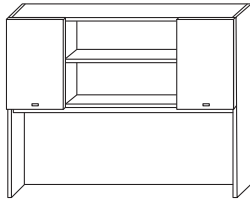

FA62M2-PNP	3 yds	4341	4689	5210	72	15 3/4	56	312
------------	-------	------	------	------	----	--------	----	-----

Veneer species must be noted on each line item

Flush top without profile edge detail, fabric tack panel (fabric not included, COM must be acrylic backed). Open center storage, one adjustable shelf. Cabinet back unfinished. Optional task lights available, see HBF Casegood Accessories.

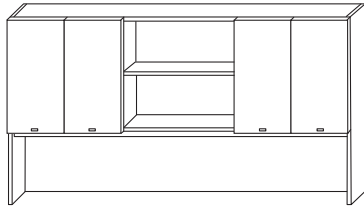

FA62N2-PNP	3 yds	4959	5356	5951	78	15 3/4	56	319
FA62P2-PNP	3 yds	5186	5601	6223	84	15 3/4	56	326
FA62R2-PNP	3 yds	5413	5846	6495	90	15 3/4	56	379
FA62S2-PNP	3 1/4 yds	5629	6079	6755	96	15 3/4	56	391
FA62T2-PNP	3 1/2 yds	5856	6324	7027	102	15 3/4	56	405
FA62U2-PNP	3 3/4 yds	6082	6569	7299	108	15 3/4	56	416
FA62V2-PNP	4 1/4 yds	6319	6825	7583	114	15 3/4	56	441
FA62W2-PNP	4 1/4 yds	6556	7080	7867	120	15 3/4	56	456

Veneer species must be noted on each line item

Flush top without profile edge detail, fabric tack panel (fabric not included, COM must be acrylic backed). Open center storage, one adjustable shelf. Cabinet back unfinished. Optional task lights available, see HBF Casegood Accessories.

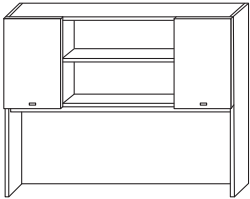

FA63M2-PNP		4620	4989	5543	72	15 3/4	56	312
------------	--	------	------	------	----	--------	----	-----

Veneer species must be noted on each line item

Flush top without profile edge detail, finished wood panel. Open center storage, one adjustable shelf. Cabinet back unfinished. Optional task lights available, see HBF Casegood Accessories.

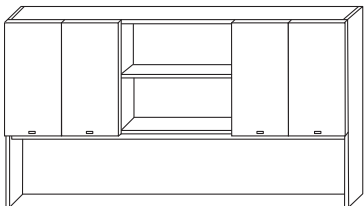

FA63N2-PNP		5268	5690	6322	78	15 3/4	56	319
FA63P2-PNP		5526	5968	6631	84	15 3/4	56	326
FA63R2-PNP		5742	6202	6891	90	15 3/4	56	379
FA63S2-PNP		5989	6469	7187	96	15 3/4	56	391
FA63T2-PNP		6237	6736	7484	102	15 3/4	56	405
FA63U2-PNP		6463	6980	7756	108	15 3/4	56	416
FA63V2-PNP		6700	7236	8040	114	15 3/4	56	441
FA63W2-PNP		6937	7492	8324	120	15 3/4	56	456

Veneer species must be noted on each line item

Flush top without profile edge detail, finished wood panel. Open center storage, one adjustable shelf. Cabinet back unfinished. Optional task lights available, see HBF Casegood Accessories.

Double high overhead cabinets to be used with double high vertical cabinets.

Veneer species must be noted on each line item

Veneer Grade 1	Veneer Grade 2	Veneer Grade 3
Cherry	Rift Oak	Anigre
Maple	Sapele	
Ligno-Grain		
Walnut		

HBF Fairmont Casegoods - Overhead Cabinets

Style Number	Fabric	List Price			Dimensions			Weight
		Veneer 1	Veneer 2	Veneer 3	OW	OD	OH	

Overhead Cabinets, Top without Profile Edge Detail, Wood Panel Support (Double High)

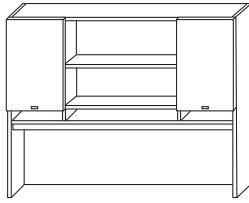

FA62M2-PWP	3 yds	4795	5178	5754	72	15 3/4	56	312
------------	-------	------	------	------	----	--------	----	-----

Veneer species must be noted on each line item

Flush top without profile edge detail, fabric tack panel (fabric not included, COM must be acrylic backed). Open center storage, one adjustable shelf, open project shelf storage 3" high. Cabinet back unfinished. Optional task lights available, see HBF Casegood Accessories.

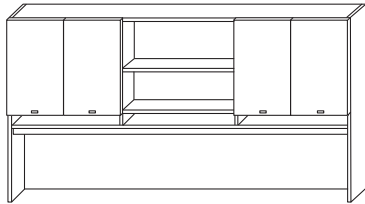

FA62N2-PWP	3 yds	5485	5924	6582	78	15 3/4	56	319
FA62P2-PWP	3 yds	5732	6191	6878	84	15 3/4	56	326
FA62R2-PWP	3 yds	5979	6457	7175	90	15 3/4	56	379
FA62S2-PWP	3 1/4 yds	6216	6713	7459	96	15 3/4	56	391
FA62T2-PWP	3 1/2 yds	6474	6991	7768	102	15 3/4	56	405
FA62U2-PWP	3 3/4 yds	6721	7258	8065	108	15 3/4	56	416
FA62V2-PWP	4 1/4 yds	6958	7514	8349	114	15 3/4	56	441
FA62W2-PWP	4 1/4 yds	7195	7770	8633	120	15 3/4	56	456

Veneer species must be noted on each line item

Flush top without profile edge detail, fabric tack panel (fabric not included, COM must be acrylic backed). Open center storage, one adjustable shelf, open project shelf storage 3" high. Cabinet back unfinished. Optional task lights available, see HBF Casegood Accessories.

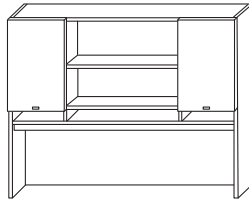

FA63M2-PWP		5104	5512	6124	72	15 3/4	56	312
------------	--	------	------	------	----	--------	----	-----

Veneer species must be noted on each line item

Flush top without profile edge detail, finished wood panel. Open center storage, one adjustable shelf, open project shelf storage 3" high. Cabinet back unfinished. Optional task lights available, see HBF Casegood Accessories.

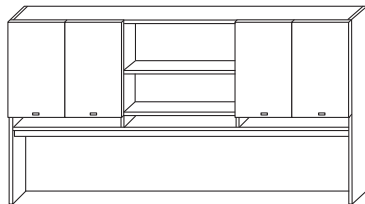

FA63N2-PWP		5825	6291	6990	78	15 3/4	56	319
FA63P2-PWP		6103	6591	7323	84	15 3/4	56	326
FA63R2-PWP		6350	6858	7620	90	15 3/4	56	379
FA63S2-PWP		6618	7147	7941	96	15 3/4	56	391
FA63T2-PWP		6896	7448	8275	102	15 3/4	56	405
FA63U2-PWP		7143	7714	8572	108	15 3/4	56	416
FA63V2-PWP		7380	7970	8856	114	15 3/4	56	441
FA63W2-PWP		7617	8226	9140	120	15 3/4	56	456

Veneer species must be noted on each line item

Flush top without profile edge detail, finished wood panel. Open center storage, one adjustable shelf, open project shelf storage 3" high. Cabinet back unfinished. Optional task lights available, see HBF Casegood Accessories.

Double high overhead cabinets to be used with double high vertical cabinets.

Veneer species must be noted on each line item

Veneer Grade 1	Veneer Grade 2	Veneer Grade 3
Cherry	Rift Oak	Anigre
Maple	Sapele	
Ligno-Grain		
Walnut		

HBF Fairmont Casegoods - Overhead Cabinets

Style Number	Fabric	List Price			Dimensions			Weight
		Veneer 1	Veneer 2	Veneer 3	OW	OD	OH	

Overhead Cabinets, Top with Profile Edge Detail, Wood Panel Support

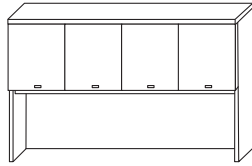

FA62A-FNP	3 yds	3816	4121	4579	72	15 3/4	43 5/8	282
-----------	-------	------	------	------	----	--------	--------	-----

Veneer species must be noted on each line item

Top with profile edge detail, fabric tack panel (fabric not included, COM must be acrylic backed), cabinet back unfinished. Optional task lights available, see HBF Casegood Accessories.

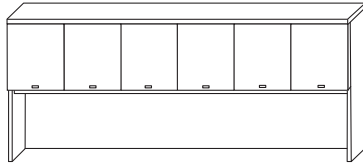

FA62F-FNP	3 yds	4362	4711	5234	78	15 3/4	43 5/8	289
FA62B-FNP	3 yds	4568	4933	5482	84	15 3/4	43 5/8	296
FA62C-FNP	3 yds	4455	4811	5346	90	15 3/4	43 5/8	339
FA62D-FNP	3 1/4 yds	4949	5345	5939	96	15 3/4	43 5/8	351
FA62G-FNP	3 1/2 yds	5155	5568	6186	102	15 3/4	43 5/8	365
FA62E-FNP	3 3/4 yds	5351	5779	6421	108	15 3/4	43 5/8	376
FA62H-FNP	4 1/4 yds	5536	5979	6644	114	15 3/4	43 5/8	391
FA62J-FNP	4 1/4 yds	5722	6179	6866	120	15 3/4	43 5/8	406

Veneer species must be noted on each line item

Top with profile edge detail, fabric tack panel (fabric not included, COM must be acrylic backed), cabinet back unfinished. Optional task lights available, see HBF Casegood Accessories.

Overhead Cabinets, Top with Profile Edge Detail, Wood Panel Support

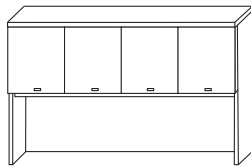

FA63A-FNP		4063	4388	4876	72	15 3/4	43 5/8	282
-----------	--	------	------	------	----	--------	--------	-----

Veneer species must be noted on each line item

Top with profile edge detail, finished wood panel, cabinet back unfinished. Optional task lights available, see HBF Casegood Accessories.

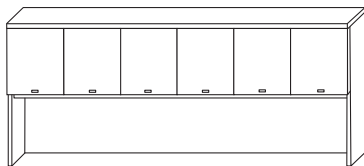

FA63F-FNP		4640	5011	5568	78	15 3/4	43 5/8	289
FA63B-FNP		4856	5245	5828	84	15 3/4	43 5/8	296
FA63C-FNP		5062	5467	6075	90	15 3/4	43 5/8	339
FA63D-FNP		5268	5690	6322	96	15 3/4	43 5/8	351
FA63G-FNP		5495	5935	6594	102	15 3/4	43 5/8	365
FA63E-FNP		5691	6146	6829	108	15 3/4	43 5/8	376
FA63H-FNP		5876	6346	7051	114	15 3/4	43 5/8	391
FA63J-FNP		6062	6546	7274	120	15 3/4	43 5/8	406

Veneer species must be noted on each line item

Top with profile edge detail, finished wood panel, cabinet back unfinished. Optional task lights available, see HBF Casegood Accessories.

Veneer species must be noted on each line item

Veneer Grade 1	Veneer Grade 2	Veneer Grade 3
Cherry	Rift Oak	Anigre
Maple	Sapele	
Ligno-Grain		
Walnut		

HBF Fairmont Casegoods - Overhead Cabinets

Style Number	Fabric	List Price			Dimensions			Weight
		Veneer 1	Veneer 2	Veneer 3	OW	OD	OH	

Overhead Cabinets, Top with Profile Edge Detail, Wood Panel Support

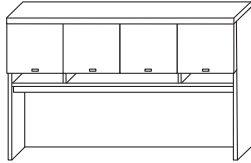

FA62A-FWP	3 yds	4197	4533	5037	72	15 3/4	43 5/8	282
------------------	-------	-------------	-------------	-------------	----	--------	--------	-----

Veneer species must be noted on each line item

Top with profile edge detail, fabric tack panel. Open project shelf storage 3" high. Cabinet back unfinished. Optional task lights available, see HBF Casegood Accessories.

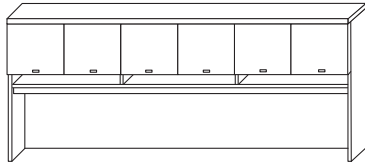

FA62F-FWP	3 yds	4805	5189	5766	78	15 3/4	43 5/8	289
FA62B-FWP	3 yds	5021	5423	6026	84	15 3/4	43 5/8	296
FA62C-FWP	3 yds	5238	5657	6285	90	15 3/4	43 5/8	339
FA62D-FWP	3 1/4 yds	5444	5879	6532	96	15 3/4	43 5/8	351
FA62G-FWP	3 1/2 yds	5670	6124	6804	102	15 3/4	43 5/8	365
FA62E-FWP	3 3/4 yds	5886	6357	7064	108	15 3/4	43 5/8	376
FA62H-FWP	4 1/4 yds	6072	6558	7286	114	15 3/4	43 5/8	391
FA62J-FWP	4 1/4 yds	6257	6758	7509	120	15 3/4	43 5/8	406

Veneer species must be noted on each line item

Top with profile edge detail, fabric tack panel. Open project shelf storage 3" high. Cabinet back unfinished. Optional task lights available, see HBF Casegood Accessories.

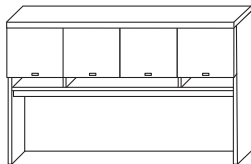

FA63A-FWP		4475	4833	5370	72	15 3/4	43 5/8	282
------------------	--	-------------	-------------	-------------	----	--------	--------	-----

Veneer species must be noted on each line item

Top with profile edge detail, finished wood panel. Open project shelf storage 3" high. Cabinet back unfinished. Optional task lights available, see HBF Casegood Accessories.

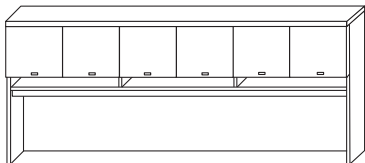

FA63F-FWP		5104	5512	6124	78	15 3/4	43 5/8	289
FA63B-FWP		5351	5779	6421	84	15 3/4	43 5/8	296
FA63C-FWP		5567	6013	6681	90	15 3/4	43 5/8	339
FA63D-FWP		5794	6257	6953	96	15 3/4	43 5/8	351
FA63G-FWP		6041	6524	7249	102	15 3/4	43 5/8	365
FA63E-FWP		6257	6758	7509	108	15 3/4	43 5/8	376
FA63H-FWP		6443	6958	7731	114	15 3/4	43 5/8	391
FA63J-FWP		6628	7158	7954	120	15 3/4	43 5/8	406

Veneer species must be noted on each line item

Top with profile edge detail, finished wood panel. Open project shelf storage 3" high. Cabinet back unfinished. Optional task lights available, see HBF Casegood Accessories.

Veneer species must be noted on each line item

<u>Veneer Grade 1</u>	<u>Veneer Grade 2</u>	<u>Veneer Grade 3</u>
Cherry	Rift Oak	Anigre
Maple	Sapele	
Ligno-Grain		
Walnut		

HBF Fairmont Casegoods - Overhead Cabinets

Style Number	Fabric	List Price			Dimensions			Weight
		Veneer 1	Veneer 2	Veneer 3	OW	OD	OH	

Overhead Cabinets, Top with Profile Edge Detail, Wood Panel Support

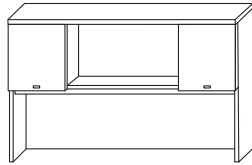

FA62A-PNP	3 yds	3631	3921	4357	72	15 3/4	43 5/8	282
------------------	-------	-------------	-------------	-------------	----	--------	--------	-----

Veneer species must be noted on each line item

Top with profile edge detail, fabric tack panel (fabric not included, COM must be acrylic backed). Open center storage. Cabinet back unfinished. Optional task lights available, see HBF Casegood Accessories.

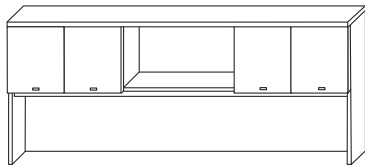

FA62F-PNP	3 yds	4146	4477	4975	78	15 3/4	43 5/8	289
FA62B-PNP	3 yds	4341	4689	5210	84	15 3/4	43 5/8	296
FA62C-PNP	3 yds	4527	4899	5432	90	15 3/4	43 5/8	339
FA62D-PNP	3 1/4 yds	4702	5078	5642	96	15 3/4	43 5/8	351
FA62G-PNP	3 1/2 yds	4898	5289	5877	102	15 3/4	43 5/8	365
FA62E-PNP	3 3/4 yds	5083	5490	6100	108	15 3/4	43 5/8	376
FA62H-PNP	4 1/4 yds	5268	5690	6322	114	15 3/4	43 5/8	391
FA62J-PNP	4 1/4 yds	5454	5890	6545	120	15 3/4	43 5/8	406

Veneer species must be noted on each line item

Top with profile edge detail, fabric tack panel (fabric not included, COM must be acrylic backed). Open center storage. Cabinet back unfinished. Optional task lights available, see HBF Casegood Accessories.

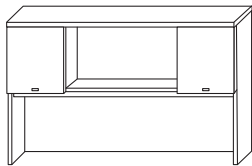

FA63A-PNP		3868	4177	4641	72	15 3/4	43 5/8	282
------------------	--	-------------	-------------	-------------	----	--------	--------	-----

Veneer species must be noted on each line item

Top with profile edge detail, finished wood panel. Open center storage. Cabinet back unfinished. Optional task lights available, see HBF Casegood Accessories.

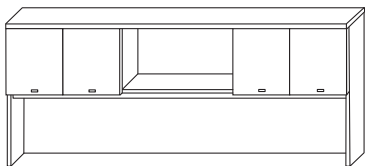

FA63F-PNP		4403	4756	5284	78	15 3/4	43 5/8	289
FA63B-PNP		4620	4989	5543	84	15 3/4	43 5/8	296
FA63C-PNP		4805	5189	5766	90	15 3/4	43 5/8	339
FA63D-PNP		5011	5412	6013	96	15 3/4	43 5/8	351
FA63G-PNP		5217	5634	6260	102	15 3/4	43 5/8	365
FA63E-PNP		5402	5835	6483	108	15 3/4	43 5/8	376
FA63H-PNP		5588	6035	6706	114	15 3/4	43 5/8	391
FA63J-PNP		5773	6235	6928	120	15 3/4	43 5/8	406

Veneer species must be noted on each line item

Top with profile edge detail, finished wood panel. Open center storage. Cabinet back unfinished. Optional task lights available, see HBF Casegood Accessories.

Veneer species must be noted on each line item

<u>Veneer Grade 1</u>	<u>Veneer Grade 2</u>	<u>Veneer Grade 3</u>
Cherry	Rift Oak	Anigre
Maple	Sapele	
Ligno-Grain		
Walnut		

HBF Fairmont Casegoods - Overhead Cabinets

Style Number	Fabric	List Price			Dimensions			Weight
		Veneer 1	Veneer 2	Veneer 3	OW	OD	OH	

Overhead Cabinets, Top with Profile Edge Detail, Wood Panel Support

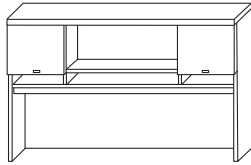

FA62A-PWP	3 yds	3826	4133	4592	72	15 3/4	43 5/8	282
------------------	-------	-------------	-------------	-------------	----	--------	--------	-----

Veneer species must be noted on each line item

Top with profile edge detail, fabric tack panel (fabric not included, COM must be acrylic backed). Open project shelf storage and open center storage 3" high. Cabinet back unfinished. Optional task lights available, see HBF Casegood Accessories.

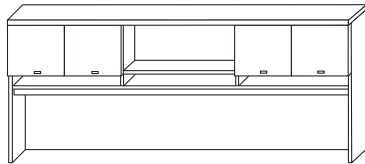

FA62F-PWP	3 yds	4578	4945	5494	78	15 3/4	43 5/8	289
FA62B-PWP	3 yds	4795	5178	5754	84	15 3/4	43 5/8	296
FA62C-PWP	3 yds	5001	5401	6001	90	15 3/4	43 5/8	339
FA62D-PWP	3 1/4 yds	5207	5623	6248	96	15 3/4	43 5/8	351
FA62G-PWP	3 1/2 yds	5413	5846	6495	102	15 3/4	43 5/8	365
FA62E-PWP	3 3/4 yds	5619	6068	6742	108	15 3/4	43 5/8	376
FA62H-PWP	4 1/4 yds	5804	6268	6965	114	15 3/4	43 5/8	391
FA62J-PWP	4 1/4 yds	5989	6469	7187	120	15 3/4	43 5/8	406

Veneer species must be noted on each line item

Top with profile edge detail, fabric tack panel (fabric not included, COM must be acrylic backed). Open project shelf storage and open center storage 3" high. Cabinet back unfinished. Optional task lights available, see HBF Casegood Accessories.

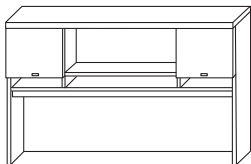

FA63A-PWP		4269	4611	5123	72	15 3/4	43 5/8	282
------------------	--	-------------	-------------	-------------	----	--------	--------	-----

Veneer species must be noted on each line item

Top with profile edge detail, finished wood panel. Open project shelf storage and open center storage 3" high. Cabinet back unfinished. Optional task lights available, see HBF Casegood Accessories.

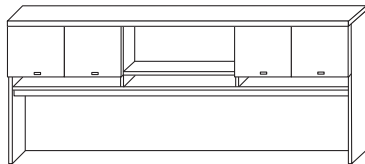

FA63F-PWP		4867	5256	5840	78	15 3/4	43 5/8	289
FA63B-PWP		5104	5512	6124	84	15 3/4	43 5/8	296
FA63C-PWP		5310	5734	6372	90	15 3/4	43 5/8	339
FA63D-PWP		5536	5979	6644	96	15 3/4	43 5/8	351
FA63G-PWP		5763	6224	6915	102	15 3/4	43 5/8	365
FA63E-PWP		5969	6446	7163	108	15 3/4	43 5/8	376
FA63H-PWP		6154	6647	7385	114	15 3/4	43 5/8	391
FA63J-PWP		6340	6847	7608	120	15 3/4	43 5/8	406

Veneer species must be noted on each line item

Top with profile edge detail, finished wood panel. Open project shelf storage and open center storage 3" high. Cabinet back unfinished. Optional task lights available, see HBF Casegood Accessories.

Veneer species must be noted on each line item

<u>Veneer Grade 1</u>	<u>Veneer Grade 2</u>	<u>Veneer Grade 3</u>
Cherry	Rift Oak	Anigre
Maple	Sapele	
Ligno-Grain		
Walnut		

HBF Fairmont Casegoods - Overhead Cabinets

Style Number	Fabric	List Price			Dimensions			Weight
		Veneer 1	Veneer 2	Veneer 3	OW	OD	OH	

Overhead Cabinets, Top with Profile Edge Detail, Wood Panel Support (Double High)

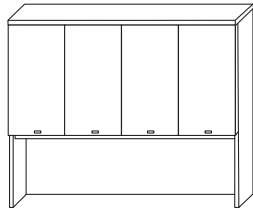

FA62A2-FNP	3 yds	5155	5568	6186	72	15 3/4	57 3/8	282
------------	-------	------	------	------	----	--------	--------	-----

Veneer species must be noted on each line item

Top with profile edge detail, one adjustable shelf, fabric tack panel (fabric not included, COM must be acrylic backed). Cabinet back unfinished. Optional task lights available, see HBF Casegood Accessories.

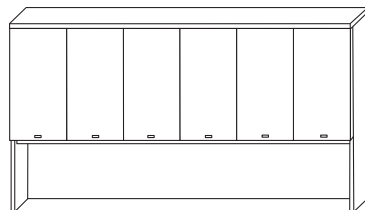

FA62F2-FNP	3 yds	5897	6368	7076	78	15 3/4	57 3/8	289
FA62B2-FNP	3 yds	6175	6669	7410	84	15 3/4	57 3/8	296
FA62C2-FNP	3 yds	6432	6947	7719	90	15 3/4	57 3/8	339
FA62D2-FNP	3 1/4 yds	6690	7225	8028	96	15 3/4	57 3/8	351
FA62G2-FNP	3 1/2 yds	6968	7525	8362	102	15 3/4	57 3/8	365
FA62E2-FNP	3 3/4 yds	7225	7803	8671	108	15 3/4	57 3/8	376
FA62H2-FNP	4 1/4 yds	7462	8059	8955	114	15 3/4	57 3/8	391
FA62J2-FNP	4 1/4 yds	7699	8315	9239	120	15 3/4	57 3/8	406

Veneer species must be noted on each line item

Top with profile edge detail, one adjustable shelf, fabric tack panel (fabric not included, COM must be acrylic backed). Cabinet back unfinished. Optional task lights available, see HBF Casegood Accessories.

Overhead Cabinets, Top with Profile Edge Detail, Wood Panel Support

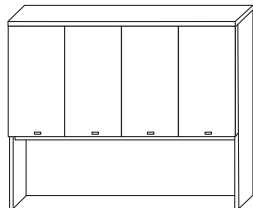

FA63A2-FNP		5495	5935	6594	72	15 3/4	57 3/8	312
------------	--	------	------	------	----	--------	--------	-----

Veneer species must be noted on each line item

Top with profile edge detail, one adjustable shelf, finished wood panel. Cabinet back unfinished. Optional task lights available, see HBF Casegood Accessories.

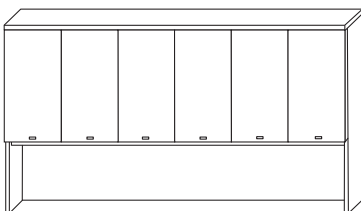

FA63F2-FNP		6268	6769	7521	78	15 3/4	57 3/8	319
FA63B2-FNP		6566	7092	7880	84	15 3/4	57 3/8	326
FA63C2-FNP		6834	7381	8201	90	15 3/4	57 3/8	379
FA63D2-FNP		7122	7692	8547	96	15 3/4	57 3/8	391
FA63G2-FNP		7421	8015	8905	102	15 3/4	57 3/8	405
FA63E2-FNP		7689	8304	9227	108	15 3/4	57 3/8	416
FA63H2-FNP		7926	8560	9511	114	15 3/4	57 3/8	441
FA63J2-FNP		8163	8816	9795	120	15 3/4	57 3/8	456

Veneer species must be noted on each line item

Top with profile edge detail, one adjustable shelf, finished wood panel, Cabinet back unfinished. Optional task lights available, see HBF Casegood Accessories.

Double high overhead cabinets to be used with double high vertical cabinets.

Veneer species must be noted on each line item

Veneer Grade 1	Veneer Grade 2	Veneer Grade 3
Cherry	Rift Oak	Anigre
Maple	Sapele	
Ligno-Grain		
Walnut		

HBF Fairmont Casegoods - Overhead Cabinets

Style Number	Fabric	List Price			Dimensions			Weight
		Veneer 1	Veneer 2	Veneer 3	OW	OD	OH	

Overhead Cabinets, Top with Profile Edge Detail, Wood Panel Support (Double High)

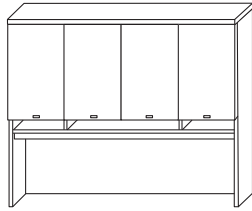

FA62A2-FWP	3 yds	5670	6124	6804	72	15 3/4	57 3/8	312
------------	-------	------	------	------	----	--------	--------	-----

Veneer species must be noted on each line item

Top with profile edge detail, one adjustable shelf, fabric tack panel, (fabric not included, COM must be acrylic backed). Open project shelf storage 3" high. Cabinet back unfinished. Optional task lights available, see HBF Casegood Accessories.

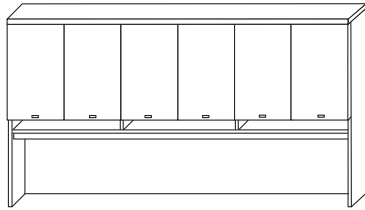

FA62F2-FWP	3 yds	6484	7003	7781	78	15 3/4	57 3/8	319
FA62B2-FWP	3 yds	6793	7336	8151	84	15 3/4	57 3/8	326
FA62C2-FWP	3 yds	7081	7648	8498	90	15 3/4	57 3/8	379
FA62D2-FWP	3 1/4 yds	7359	7948	8831	96	15 3/4	57 3/8	391
FA62G2-FWP	3 1/2 yds	7668	8282	9202	102	15 3/4	57 3/8	405
FA62E2-FWP	3 3/4 yds	7946	8582	9536	108	15 3/4	57 3/8	416
FA62H2-FWP	4 1/4 yds	8183	8838	9820	114	15 3/4	57 3/8	441
FA62J2-FWP	4 1/4 yds	8420	9094	10104	120	15 3/4	57 3/8	456

Veneer species must be noted on each line item

Top with profile edge detail, one adjustable shelf, fabric tack panel, (fabric not included, COM must be acrylic backed). Open project shelf storage 3" high. Cabinet back unfinished. Optional task lights available, see HBF Casegood Accessories.

Overhead Cabinets, Top with Profile Edge Detail, Wood Panel Support

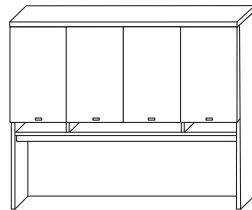

FA63A2-FWP		6051	6535	7262	72	15 3/4	57 3/8	312
------------	--	------	------	------	----	--------	--------	-----

Veneer species must be noted on each line item

Top with profile edge detail, one adjustable shelf, finished wood panel. Open project shelf storage 3" high. Cabinet back unfinished. Optional task lights available, see HBF Casegood Accessories.

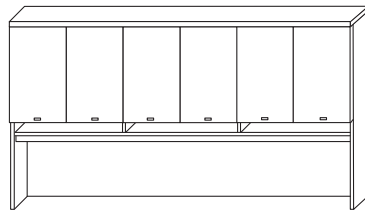

FA63F2-FWP		6896	7448	8275	78	15 3/4	57 3/8	319
FA63B2-FWP		7225	7803	8671	84	15 3/4	57 3/8	326
FA63C2-FWP		7514	8115	9017	90	15 3/4	57 3/8	379
FA63D2-FWP		7833	8460	9400	96	15 3/4	57 3/8	391
FA63G2-FWP		8163	8816	9795	102	15 3/4	57 3/8	405
FA63E2-FWP		8461	9138	10154	108	15 3/4	57 3/8	416
FA63H2-FWP		8698	9394	10438	114	15 3/4	57 3/8	441
FA63J2-FWP		8904	9617	10685	120	15 3/4	57 3/8	456

Veneer species must be noted on each line item

Top with profile edge detail, one adjustable shelf, finished wood panel. Open project shelf storage 3" high. Cabinet back unfinished. Optional task lights available, see HBF Casegood Accessories.

Double high overhead cabinets to be used with double high vertical cabinets.

Veneer species must be noted on each line item

Veneer Grade 1	Veneer Grade 2	Veneer Grade 3
Cherry	Rift Oak	Anigre
Maple	Sapele	
Ligno-Grain		
Walnut		

HBF Fairmont Casegoods - Overhead Cabinets

Style Number	Fabric	List Price			Dimensions			Weight
		Veneer 1	Veneer 2	Veneer 3	OW	OD	OH	

Overhead Cabinets, Top with Profile Edge Detail, Wood Panel Support (Double High)

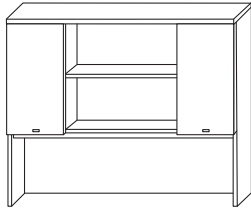

FA62A2-PNP	3 yds	4898	5289	5877	72	15 3/4	57 3/8	312
------------	-------	------	------	------	----	--------	--------	-----

Veneer species must be noted on each line item

Top with profile edge detail, fabric tack panel (fabric not included, COM must be acrylic backed). Open center storage, one adjustable shelf. Cabinet back unfinished. Optional task lights available, see HBF Casegood Accessories.

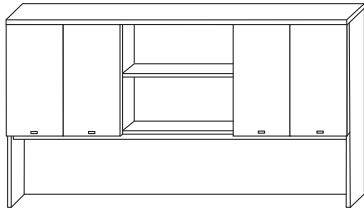

FA62F2-PNP	3 yds	5598	6046	6718	78	15 3/4	57 3/8	319
FA62B2-PNP	3 yds	5866	6335	7039	84	15 3/4	57 3/8	326
FA62C2-PNP	3 yds	6113	6602	7336	90	15 3/4	57 3/8	379
FA62D2-PNP	3 1/4 yds	6360	6869	7632	96	15 3/4	57 3/8	391
FA62G2-PNP	3 1/2 yds	6618	7147	7941	102	15 3/4	57 3/8	405
FA62E2-PNP	3 3/4 yds	6865	7414	8238	108	15 3/4	57 3/8	416
FA62H2-PNP	4 1/4 yds	7102	7670	8522	114	15 3/4	57 3/8	441
FA62J2-PNP	4 1/4 yds	7339	7926	8807	120	15 3/4	57 3/8	456

Veneer species must be noted on each line item

Top with profile edge detail, fabric tack panel (fabric not included, COM must be acrylic backed). Open center storage, one adjustable shelf. Cabinet back unfinished. Optional task lights available, see HBF Casegood Accessories.

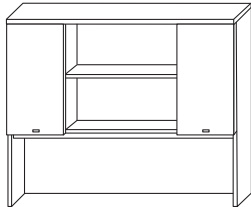

FA63A2-PNP		5227	5645	6273	72	15 3/4	57 3/8	312
------------	--	------	------	------	----	--------	--------	-----

Veneer species must be noted on each line item

Top with profile edge detail, finished wood panel. Open center storage, one adjustable shelf. Cabinet back unfinished. Optional task lights available, see HBF Casegood Accessories.

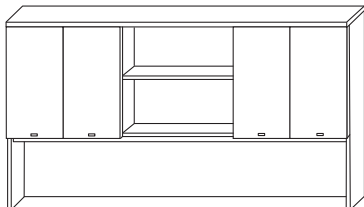

FA63F2-PNP		5959	6435	7150	78	15 3/4	57 3/8	319
FA63B2-PNP		6237	6736	7484	84	15 3/4	57 3/8	326
FA63C2-PNP		6494	7014	7793	90	15 3/4	57 3/8	379
FA63D2-PNP		6762	7303	8114	96	15 3/4	57 3/8	391
FA63G2-PNP		7050	7614	8460	102	15 3/4	57 3/8	405
FA63E2-PNP		7308	7892	8769	108	15 3/4	57 3/8	416
FA63H2-PNP		7545	8148	9054	114	15 3/4	57 3/8	441
FA63J2-PNP		7782	8404	9338	120	15 3/4	57 3/8	456

Veneer species must be noted on each line item

Top with profile edge detail, finished wood panel. Open center storage, one adjustable shelf. Cabinet back unfinished. Optional task lights available, see HBF Casegood Accessories.

Double high overhead cabinets to be used with double high vertical cabinets.

Veneer species must be noted on each line item

<u>Veneer Grade 1</u>	<u>Veneer Grade 2</u>	<u>Veneer Grade 3</u>
Cherry	Rift Oak	Anigre
Maple	Sapele	
Ligno-Grain		
Walnut		

HBF Fairmont Casegoods - Overhead Cabinets

Style Number	Fabric	List Price			Dimensions			Weight
		Veneer 1	Veneer 2	Veneer 3	OW	OD	OH	

Overhead Cabinets, Top with Profile Edge Detail, Wood Panel Support (Double High)

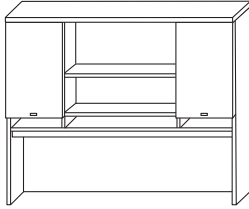

FA62A2-PWP	3 yds	5413	5846	6495	72	15 3/4	57 3/8	312
-------------------	-------	-------------	-------------	-------------	----	--------	--------	-----

Veneer species must be noted on each line item

Top with profile edge detail, fabric tack panel (fabric not included, COM must be acrylic backed). Open center storage, one adjustable shelf, open project shelf storage 3" high. Cabinet back unfinished. Optional task lights available, see HBF Casegood Accessories.

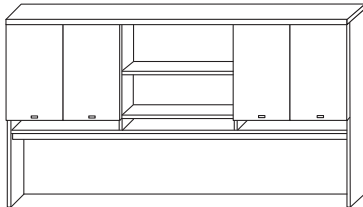

FA62F2-PWP	3 yds	6195	6691	7435	78	15 3/4	57 3/8	319
FA62B2-PWP	3 yds	6484	7003	7781	84	15 3/4	57 3/8	326
FA62C2-PWP	3 yds	6752	7292	8102	90	15 3/4	57 3/8	379
FA62D2-PWP	3 1/4 yds	7030	7592	8436	96	15 3/4	57 3/8	391
FA62G2-PWP	3 1/2 yds	7318	7904	8782	102	15 3/4	57 3/8	405
FA62E2-PWP	3 3/4 yds	7586	8193	9103	108	15 3/4	57 3/8	416
FA62H2-PWP	4 1/4 yds	7823	8449	9387	114	15 3/4	57 3/8	441
FA62J2-PWP	4 1/4 yds	8060	8705	9672	120	15 3/4	57 3/8	456

Veneer species must be noted on each line item

Top with profile edge detail, fabric tack panel (fabric not included, COM must be acrylic backed). Open center storage, one adjustable shelf, open project shelf storage 3" high. Cabinet back unfinished. Optional task lights available, see HBF Casegood Accessories.

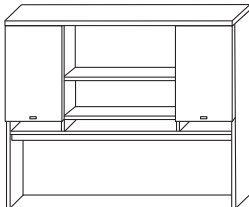

FA63A2-PWP		5773	6235	6928	72	15 3/4	57 3/8	312
-------------------	--	-------------	-------------	-------------	----	--------	--------	-----

Veneer species must be noted on each line item

Top with profile edge detail, finished wood panel. Open center storage, one adjustable shelf, open project shelf storage 3" high. Cabinet back unfinished. Optional task lights available, see HBF Casegood Accessories.

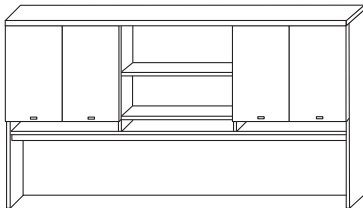

FA63F2-PWP		6577	7103	7892	78	15 3/4	57 3/8	319
FA63B2-PWP		6896	7448	8275	84	15 3/4	57 3/8	326
FA63C2-PWP		7174	7748	8609	90	15 3/4	57 3/8	379
FA63D2-PWP		7473	8070	8967	96	15 3/4	57 3/8	391
FA63G2-PWP		7792	8415	9350	102	15 3/4	57 3/8	405
FA63E2-PWP		8070	8716	9684	108	15 3/4	57 3/8	416
FA63H2-PWP		8307	8972	9968	114	15 3/4	57 3/8	441
FA63J2-PWP		8544	9227	10253	120	15 3/4	57 3/8	456

Veneer species must be noted on each line item

Top with profile edge detail, finished wood panel. Open center storage, one adjustable shelf, open project shelf storage 3" high. Cabinet back unfinished. Optional task lights available, see HBF Casegood Accessories.

Double high overhead cabinets to be used with double high vertical cabinets.

Veneer species must be noted on each line item

<u>Veneer Grade 1</u>	<u>Veneer Grade 2</u>	<u>Veneer Grade 3</u>
Cherry	Rift Oak	Anigre
Maple	Sapele	
Ligno-Grain		
Walnut		

HBF Fairmont Casegoods - Overhead Cabinets

Style Number	Fabric	List Price			Dimensions			Weight
		Veneer 1	Veneer 2	Veneer 3	OW	OD	OH	

Overhead Cabinets, Top without Profile Edge Detail

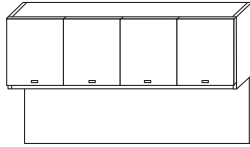

FA64M-FNP	3 yds	3178	3432	3813	72	15 3/4	42 1/4	195
------------------	-------	-------------	-------------	-------------	----	--------	--------	-----

Veneer species must be noted on each line item

Wall mount, flush top without profile edge detail, fabric tack panel (fabric not included, COM must be acrylic backed), cabinet back unfinished. Optional task lights available, see HBF Casegood Accessories.

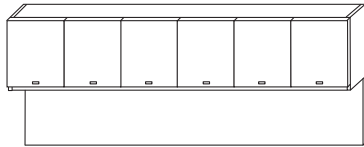

FA64N-FNP	3 yds	3651	3943	4382	78	15 3/4	42 1/4	215
FA64P-FNP	3 yds	3837	4144	4604	84	15 3/4	42 1/4	215
FA64R-FNP	3 yds	4002	4322	4802	90	15 3/4	42 1/4	225
FA64S-FNP	3 1/4 yds	4177	4511	5012	96	15 3/4	42 1/4	225
FA64T-FNP	3 1/2 yds	4362	4711	5234	102	15 3/4	42 1/4	235
FA64U-FNP	3 3/4 yds	4527	4889	5432	108	15 3/4	42 1/4	235
FA64V-FNP	4 1/4 yds	4712	5089	5655	114	15 3/4	42 1/4	245
FA64W-FNP	4 1/4 yds	4898	5289	5877	120	15 3/4	42 1/4	245

Veneer species must be noted on each line item

Wall mount, flush top without profile edge detail, fabric tack panel (fabric not included, COM must be acrylic backed), cabinet back unfinished. Optional task lights available, see HBF Casegood Accessories.

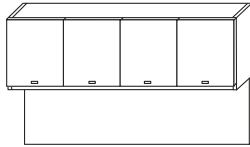

FA65M-FNP		3394	3665	4073	72	15 3/4	42 1/4	195
------------------	--	-------------	-------------	-------------	----	--------	--------	-----

Veneer species must be noted on each line item

Wall mount, flush top without profile edge detail, finished wood panel, cabinet back unfinished. Optional task lights available, see HBF Casegood Accessories.

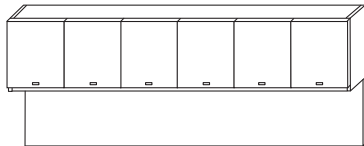

FA65N-FNP		3899	4210	4678	78	15 3/4	42 1/4	215
FA65P-FNP		4094	4422	4913	84	15 3/4	42 1/4	215
FA65R-FNP		4269	4611	5123	90	15 3/4	42 1/4	225
FA65S-FNP		4455	4811	5346	96	15 3/4	42 1/4	225
FA65T-FNP		4650	5022	5581	102	15 3/4	42 1/4	235
FA65U-FNP		4826	5212	5791	108	15 3/4	42 1/4	235
FA65V-FNP		5011	5412	6013	114	15 3/4	42 1/4	245
FA65W-FNP		5196	5612	6236	120	15 3/4	42 1/4	245

Veneer species must be noted on each line item

Wall mount, flush top without profile edge detail, finished wood panel, cabinet back unfinished. Optional task lights available, see HBF Casegood Accessories.

Installation and maintenance of wall mounted overhead cabinets are the sole responsibility of the customer. Proper installation is crucial to prevent personal injury.

Veneer species must be noted on each line item

Veneer Grade 1	Veneer Grade 2	Veneer Grade 3
Cherry	Rift Oak	Anigre
Maple	Sapele	
Ligno-Grain		
Walnut		

HBF Fairmont Casegoods - Overhead Cabinets

Style Number	Fabric	List Price			Dimensions			Weight
		Veneer 1	Veneer 2	Veneer 3	OW	OD	OH	

Overhead Cabinets, Top without Profile Edge Detail

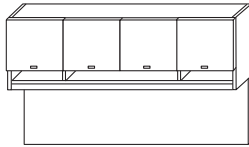

FA64M-FWP	3 yds	3517	3779	4221	72	15 3/4	42 1/4	195
------------------	-------	-------------	-------------	-------------	----	--------	--------	-----

Veneer species must be noted on each line item

Wall mount, flush top without profile edge detail, fabric tack panel (fabric not included, COM must be acrylic backed). Open project shelf storage 3" high. Cabinet back unfinished. Optional task lights available, see HBF Casegood Accessories.

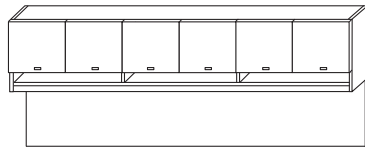

FA64N-FWP	3 yds	4043	4366	4851	78	15 3/4	42 1/4	215
FA64P-FWP	3 yds	4238	4578	5086	84	15 3/4	42 1/4	215
FA64R-FWP	3 yds	4424	4778	5309	90	15 3/4	42 1/4	225
FA64S-FWP	3 1/4 yds	4620	4989	5543	96	15 3/4	42 1/4	225
FA64T-FWP	3 1/2 yds	4815	5200	5778	102	15 3/4	42 1/4	235
FA64U-FWP	3 3/4 yds	5001	5401	6001	108	15 3/4	42 1/4	235
FA64V-FWP	4 1/4 yds	5186	5601	6223	114	15 3/4	42 1/4	245
FA64W-FWP	4 1/4 yds	5371	5801	6446	120	15 3/4	42 1/4	245

Veneer species must be noted on each line item

Wall mount, flush top without profile edge detail, fabric tack panel (fabric not included, COM must be acrylic backed). Open project shelf storage 3" high. Cabinet back unfinished. Optional task lights available, see HBF Casegood Accessories.

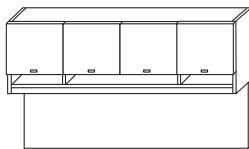

FA65M-FWP		3754	4055	4505	72	15 3/4	42 1/4	195
------------------	--	-------------	-------------	-------------	----	--------	--------	-----

Veneer species must be noted on each line item

Wall mount, flush top without profile edge detail, finished wood panel. Open project shelf storage 3" high. Cabinet back unfinished. Optional task lights available, see HBF Casegood Accessories.

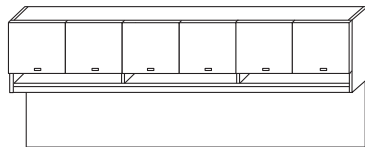

FA65N-FWP		4311	4655	5173	78	15 3/4	42 1/4	215
FA65P-FWP		4527	4889	5432	84	15 3/4	42 1/4	215
FA65R-FWP		4723	5100	5667	90	15 3/4	42 1/4	225
FA65S-FWP		4929	5323	5914	96	15 3/4	42 1/4	225
FA65T-FWP		5145	5556	6174	102	15 3/4	42 1/4	235
FA65U-FWP		5330	5757	6396	108	15 3/4	42 1/4	235
FA65V-FWP		5516	5957	6619	114	15 3/4	42 1/4	245
FA65W-FWP		5701	6157	6841	120	15 3/4	42 1/4	245

Veneer species must be noted on each line item

Wall mount, flush top without profile edge detail, finished wood panel. Open project shelf storage 3" high. Cabinet back unfinished. Optional task lights available, see HBF Casegood Accessories.

**Installation and maintenance of wall mounted overhead cabinets are the sole responsibility of the customer.
Proper installation is crucial to prevent personal injury.**

Veneer species must be noted on each line item

<u>Veneer Grade 1</u>	<u>Veneer Grade 2</u>	<u>Veneer Grade 3</u>
Cherry	Rift Oak	Anigre
Maple	Sapele	
Ligno-Grain		
Walnut		

HBF Fairmont Casegoods - Overhead Cabinets

Style Number	Fabric	List Price			Dimensions			Weight
		Veneer 1	Veneer 2	Veneer 3	OW	OD	OH	

Overhead Cabinets, Top without Profile Edge Detail

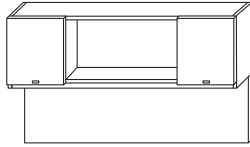

FA64M-PNP	3 yds	3002	3243	3603	72	15 3/4	42 1/4	189
------------------	-------	-------------	-------------	-------------	----	--------	--------	-----

Veneer species must be noted on each line item

Wall mount, flush top without profile edge detail, fabric tack panel (fabric not included, COM must be acrylic backed). Open center storage. Cabinet back unfinished. Optional task lights available, see HBF Casegood Accessories.

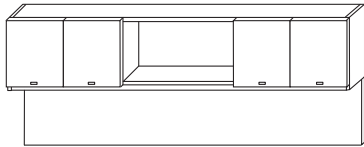

FA64N-PNP	3 yds	3466	3743	4159	78	15 3/4	42 1/4	205
FA64P-PNP	3 yds	3631	3921	4357	84	15 3/4	42 1/4	205
FA64R-PNP	3 yds	3796	4099	4555	90	15 3/4	42 1/4	215
FA64S-PNP	3 1/4 yds	3960	4277	4752	96	15 3/4	42 1/4	215
FA64T-PNP	3 1/2 yds	4125	4455	4950	102	15 3/4	42 1/4	225
FA64U-PNP	3 3/4 yds	4290	4633	5148	108	15 3/4	42 1/4	225
FA64V-PNP	4 1/4 yds	4475	4833	5370	114	15 3/4	42 1/4	235
FA64W-PNP	4 1/4 yds	4661	5034	5593	120	15 3/4	42 1/4	235

Veneer species must be noted on each line item

Wall mount, flush top without profile edge detail, fabric tack panel (fabric not included, COM must be acrylic backed). Open center storage. Cabinet back unfinished. Optional task lights available, see HBF Casegood Accessories.

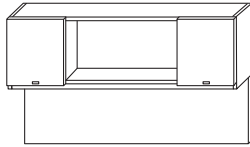

FA65M-PNP		3219	3476	3863	72	15 3/4	42 1/4	189
------------------	--	-------------	-------------	-------------	----	--------	--------	-----

Veneer species must be noted on each line item

Wall mount, flush top without profile edge detail, finished wood panel. Open center storage. Cabinet back unfinished. Optional task lights available, see HBF Casegood Accessories.

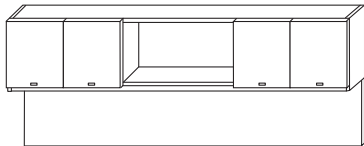

FA65N-PNP		3693	3988	4431	78	15 3/4	42 1/4	205
FA65P-PNP		3878	4188	4654	84	15 3/4	42 1/4	205
FA65R-PNP		4043	4366	4851	90	15 3/4	42 1/4	215
FA65S-PNP		4228	4566	5074	96	15 3/4	42 1/4	215
FA65T-PNP		4414	4767	5296	102	15 3/4	42 1/4	225
FA65U-PNP		4578	4945	5494	108	15 3/4	42 1/4	225
FA65V-PNP		4764	5145	5717	114	15 3/4	42 1/4	235
FA65W-PNP		4949	5345	5939	120	15 3/4	42 1/4	235

Veneer species must be noted on each line item

Wall mount, flush top without profile edge detail, finished wood panel. Open center storage. Cabinet back unfinished. Optional task lights available, see HBF Casegood Accessories.

Installation and maintenance of wall mounted overhead cabinets are the sole responsibility of the customer.

Proper installation is crucial to prevent personal injury.

Veneer species must be noted on each line item

<u>Veneer Grade 1</u>	<u>Veneer Grade 2</u>	<u>Veneer Grade 3</u>
Cherry	Rift Oak	Anigre
Maple	Sapele	
Ligno-Grain		
Walnut		

HBF Fairmont Casegoods - Overhead Cabinets

Style Number	Fabric	List Price			Dimensions			Weight
		Veneer 1	Veneer 2	Veneer 3	OW	OD	OH	

Overhead Cabinets, Top without Profile Edge Detail

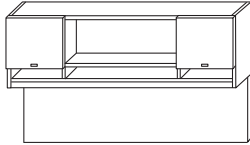

FA64M-PWP	3 yds	3342	3610	4011	72	15 3/4	42 1/4	189
------------------	-------	-------------	-------------	-------------	----	--------	--------	-----

Veneer species must be noted on each line item

Wall mount, flush top without profile edge detail, fabric tack panel (fabric not included, COM must be acrylic backed). Open project shelf storage 3" high and open center storage. Cabinet back unfinished. Optional task lights available, see HBF Casegood Accessories.

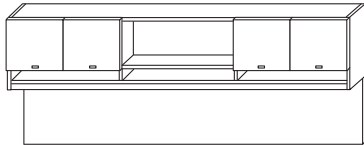

FA64N-PWP	3 yds	3847	4155	4616	78	15 3/4	42 1/4	205
FA64P-PWP	3 yds	4043	4366	4851	84	15 3/4	42 1/4	205
FA64R-PWP	3 yds	4218	4555	5061	90	15 3/4	42 1/4	215
FA64S-PWP	3 1/4 yds	4393	4744	5272	96	15 3/4	42 1/4	215
FA64T-PWP	3 1/2 yds	4589	4956	5506	102	15 3/4	42 1/4	225
FA64U-PWP	3 3/4 yds	4764	5145	5717	108	15 3/4	42 1/4	225
FA64V-PWP	4 1/4 yds	4949	5345	5939	114	15 3/4	42 1/4	235
FA64W-PWP	4 1/4 yds	5135	5545	6161	120	15 3/4	42 1/4	235

Veneer species must be noted on each line item

Wall mount, flush top without profile edge detail, fabric tack panel (fabric not included, COM must be acrylic backed). Open project shelf storage 3" high and open center storage. Cabinet back unfinished. Optional task lights available, see HBF Casegood Accessories.

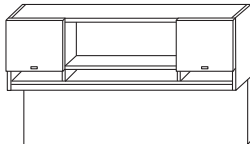

FA65M-PWP		3579	3866	4295	72	15 3/4	42 1/4	189
------------------	--	-------------	-------------	-------------	----	--------	--------	-----

Veneer species must be noted on each line item

Wall mount, flush top without profile edge detail, finished wood panel. Open project shelf storage 3" high and open center storage. Cabinet back unfinished. Optional task lights available, see HBF Casegood Accessories.

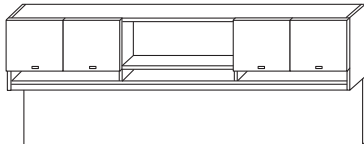

FA65N-PWP		4105	4433	4925	78	15 3/4	42 1/4	205
FA65P-PWP		4311	4655	5173	84	15 3/4	42 1/4	205
FA65R-PWP		4496	4856	5395	90	15 3/4	42 1/4	215
FA65S-PWP		4692	5067	5630	96	15 3/4	42 1/4	215
FA65T-PWP		4898	5289	5877	102	15 3/4	42 1/4	225
FA65U-PWP		5083	5490	6100	108	15 3/4	42 1/4	225
FA65V-PWP		5268	5690	6322	114	15 3/4	42 1/4	235
FA65W-PWP		5454	5890	6545	120	15 3/4	42 1/4	235

Veneer species must be noted on each line item

Wall mount, flush top without profile edge detail, finished wood panel. Open project shelf storage 3" high and open center storage. Cabinet back unfinished. Optional task lights available, see HBF Casegood Accessories.

Installation and maintenance of wall mounted overhead cabinets are the sole responsibility of the customer. Proper installation is crucial to prevent personal injury.

Veneer species must be noted on each line item

<u>Veneer Grade 1</u>	<u>Veneer Grade 2</u>	<u>Veneer Grade 3</u>
Cherry	Rift Oak	Anigre
Maple	Sapele	
Ligno-Grain		
Walnut		

HBF Fairmont Casegoods - Overhead Cabinets

Style Number	Fabric	List Price			Dimensions			Weight
		Veneer 1	Veneer 2	Veneer 3	OW	OD	OH	

Overhead Cabinets, Top without Profile Edge Detail (Double High)

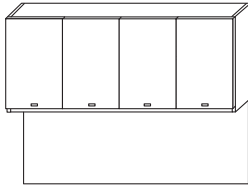

FA64M2-FNP	3 yds	4362	4711	5234	72	15 3/4	56	200
------------	-------	------	------	------	----	--------	----	-----

Veneer species must be noted on each line item

Wall mount, flush top without profile edge detail, one adjustable shelf, fabric tack panel (fabric not included, COM must be acrylic backed), cabinet back unfinished. Optional task lights available, see HBF Casegood Accessories.

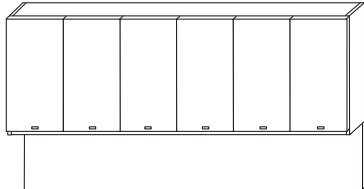

FA64N2-FNP	3 yds	5011	5412	6013	78	15 3/4	56	220
FA64P2-FNP	3 yds	5258	5679	6310	84	15 3/4	56	220
FA64R2-FNP	3 yds	5485	5924	6582	90	15 3/4	56	230
FA64S2-FNP	3 1/4 yds	5722	6179	6866	96	15 3/4	56	230
FA64T2-FNP	3 1/2 yds	5959	6435	7150	102	15 3/4	56	240
FA64U2-FNP	3 3/4 yds	6195	6691	7435	108	15 3/4	56	240
FA64V2-FNP	4 1/4 yds	6432	6947	7719	114	15 3/4	56	250
FA64W2-FNP	4 1/4 yds	6669	7203	8003	120	15 3/4	56	250

Veneer species must be noted on each line item

Wall mount, flush top without profile edge detail, one adjustable shelf, fabric tack panel (fabric not included, COM must be acrylic backed), cabinet back unfinished. Optional task lights available, see HBF Casegood Accessories.

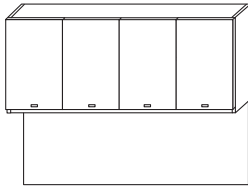

FA65M2-FNP		4661	5034	5593	72	15 3/4	56	200
------------	--	------	------	------	----	--------	----	-----

Veneer species must be noted on each line item

Wall mount, flush top without profile edge detail, one adjustable shelf, finished wood panel, cabinet back unfinished. Optional task lights available, see HBF Casegood Accessories.

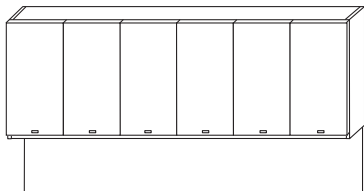

FA65N2-FNP		5341	5768	6409	78	15 3/4	56	220
FA65P2-FNP		5608	6057	6730	84	15 3/4	56	220
FA65R2-FNP		5845	6313	7014	90	15 3/4	56	230
FA65S2-FNP		6092	6580	7311	96	15 3/4	56	230
FA65T2-FNP		6360	6869	7632	102	15 3/4	56	240
FA65U2-FNP		6597	7125	7917	108	15 3/4	56	240
FA65V2-FNP		6834	7381	8201	114	15 3/4	56	250
FA65W2-FNP		7071	7637	8485	120	15 3/4	56	250

Veneer species must be noted on each line item

Wall mount, flush top without profile edge detail, one adjustable shelf, finished wood panel, cabinet back unfinished. Optional task lights available, see HBF Casegood Accessories.

**Double high overhead cabinets to be used with double high vertical cabinets.
Installation and maintenance of wall mounted overhead cabinets are the sole responsibility of the customer.
Proper installation is crucial to prevent personal injury.**

Veneer species must be noted on each line item

Veneer Grade 1	Veneer Grade 2	Veneer Grade 3
Cherry	Rift Oak	Anigre
Maple	Sapele	
Ligno-Grain		
Walnut		

HBF Fairmont Casegoods - Overhead Cabinets

Style Number	Fabric	List Price			Dimensions			Weight
		Veneer 1	Veneer 2	Veneer 3	OW	OD	OH	

Overhead Cabinets, Top without Profile Edge Detail (Double High)

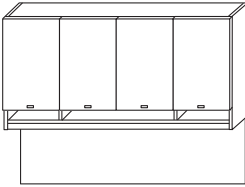

FA64M2-FWP	3 yds	4815	5200	5778	72	15 3/4	56	200
-------------------	-------	-------------	-------------	-------------	----	--------	----	-----

Veneer species must be noted on each line item

Wall mount, flush top without profile edge detail, one adjustable shelf, fabric tack panel (fabric not included, COM must be acrylic backed). Open project shelf storage 3" high. Cabinet back unfinished. Optional task lights available, see HBF Casegood Accessories.

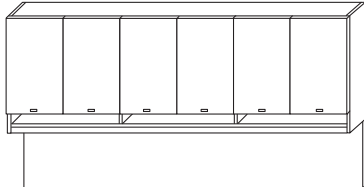

FA64N2-FWP	3 yds	5536	5979	6644	78	15 3/4	56	220
FA64P2-FWP	3 yds	5804	6268	6965	84	15 3/4	56	220
FA64R2-FWP	3 yds	6051	6535	7262	90	15 3/4	56	230
FA64S2-FWP	3 1/4 yds	6309	6813	7571	96	15 3/4	56	230
FA64T2-FWP	3 1/2 yds	6577	7103	7892	102	15 3/4	56	240
FA64U2-FWP	3 3/4 yds	6834	7381	8201	108	15 3/4	56	240
FA64V2-FWP	4 1/4 yds	7071	7637	8485	114	15 3/4	56	250
FA64W2-FWP	4 1/4 yds	7308	7892	8769	120	15 3/4	56	250

Veneer species must be noted on each line item

Wall mount, flush top without profile edge detail, one adjustable shelf, fabric tack panel (fabric not included, COM must be acrylic backed). Open project shelf storage 3" high. Cabinet back unfinished. Optional task lights available, see HBF Casegood Accessories.

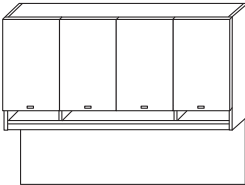

FA65M2-FWP		5145	5556	6174	72	15 3/4	56	200
-------------------	--	-------------	-------------	-------------	----	--------	----	-----

Veneer species must be noted on each line item

Wall mount, flush top without profile edge detail, one adjustable shelf, finished wood panel. Open project shelf storage 3" high. Cabinet back unfinished. Optional task lights available, see HBF Casegood Accessories.

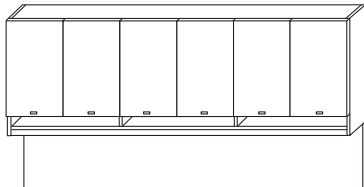

FA65N2-FWP		5897	6368	7076	78	15 3/4	56	220
FA65P2-FWP		6185	6680	7422	84	15 3/4	56	220
FA65R2-FWP		6453	6969	7744	90	15 3/4	56	230
FA65S2-FWP		6721	7258	8065	96	15 3/4	56	230
FA65T2-FWP		7019	7581	8423	102	15 3/4	56	240
FA65U2-FWP		7277	7859	8732	108	15 3/4	56	240
FA65V2-FWP		7514	8115	9017	114	15 3/4	56	250
FA65W2-FWP		7751	8371	9301	120	15 3/4	56	250

Veneer species must be noted on each line item

Wall mount, flush top without profile edge detail, one adjustable shelf, finished wood panel. Open project shelf storage 3" high. Cabinet back unfinished. Optional task lights available, see HBF Casegood Accessories.

**Double high overhead cabinets to be used with double high vertical cabinets.
Installation and maintenance of wall mounted overhead cabinets are the sole responsibility of the customer.
Proper installation is crucial to prevent personal injury.**

Veneer species must be noted on each line item

<u>Veneer Grade 1</u>	<u>Veneer Grade 2</u>	<u>Veneer Grade 3</u>
Cherry	Rift Oak	Anigre
Maple	Sapele	
Ligno-Grain		
Walnut		

HBF Fairmont Casegoods - Overhead Cabinets

Style Number	Fabric	List Price			Dimensions			Weight
		Veneer 1	Veneer 2	Veneer 3	OW	OD	OH	

Overhead Cabinets, Top without Profile Edge Detail (Double High)

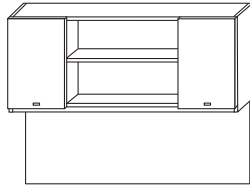

FA64M2-PNP	3 yds	4135	4466	4963	72	15 3/4	56	195
-------------------	-------	-------------	-------------	-------------	----	--------	----	-----

Veneer species must be noted on each line item

Wall mount, flush top without profile edge detail, fabric tack panel (fabric not included, COM must be acrylic backed). Open center storage, one adjustable shelf. Cabinet back unfinished. Optional task lights available, see HBF Casegood Accessories.

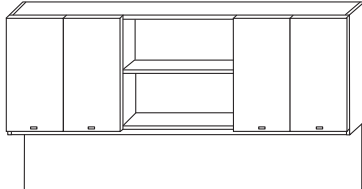

FA64N2-PNP	3 yds	4753	5134	5704	78	15 3/4	56	215
FA64P2-PNP	3 yds	4980	5378	5976	84	15 3/4	56	215
FA64R2-PNP	3 yds	5207	5623	6248	90	15 3/4	56	225
FA64S2-PNP	3 1/4 yds	5423	5857	6508	96	15 3/4	56	225
FA64T2-PNP	3 1/2 yds	5650	6102	6779	102	15 3/4	56	235
FA64U2-PNP	3 3/4 yds	5876	6346	7051	108	15 3/4	56	235
FA64V2-PNP	4 1/4 yds	6113	6602	7336	114	15 3/4	56	245
FA64W2-PNP	4 1/4 yds	6350	6858	7620	120	15 3/4	56	245

Veneer species must be noted on each line item

Wall mount, flush top without profile edge detail, fabric tack panel (fabric not included, COM must be acrylic backed). Open center storage, one adjustable shelf. Cabinet back unfinished. Optional task lights available, see HBF Casegood Accessories.

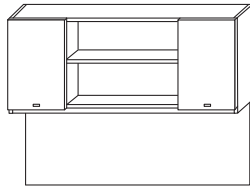

FA65M2-PNP		4414	4767	5296	72	15 3/4	56	195
-------------------	--	-------------	-------------	-------------	----	--------	----	-----

Veneer species must be noted on each line item

Wall mount, flush top without profile edge detail, finished wood panel. Open center storage, one adjustable shelf. Cabinet back unfinished. Optional task lights available, see HBF Casegood Accessories.

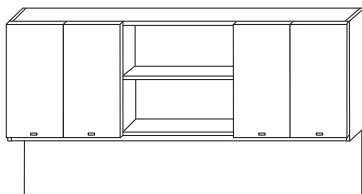

FA65N2-PNP		5062	5467	6075	78	15 3/4	56	215
FA65P2-PNP		5320	5746	6384	84	15 3/4	56	215
FA65R2-PNP		5536	5979	6644	90	15 3/4	56	225
FA65S2-PNP		5783	6246	6940	96	15 3/4	56	225
FA65T2-PNP		6031	6513	7237	102	15 3/4	56	235
FA65U2-PNP		6257	6758	7509	108	15 3/4	56	235
FA65V2-PNP		6494	7014	7793	114	15 3/4	56	245
FA65W2-PNP		6731	7270	8077	120	15 3/4	56	245

Veneer species must be noted on each line item

Wall mount, flush top without profile edge detail, finished wood panel. Open center storage, one adjustable shelf. Cabinet back unfinished. Optional task lights available, see HBF Casegood Accessories.

**Double high overhead cabinets to be used with double high vertical cabinets.
Installation and maintenance of wall mounted overhead cabinets are the sole responsibility of the customer.
Proper installation is crucial to prevent personal injury.**

Veneer species must be noted on each line item

<u>Veneer Grade 1</u>	<u>Veneer Grade 2</u>	<u>Veneer Grade 3</u>
Cherry	Rift Oak	Anigre
Maple	Sapele	
Ligno-Grain		
Walnut		

HBF Fairmont Casegoods - Overhead Cabinets

Style Number	Fabric	List Price			Dimensions			Weight
		Veneer 1	Veneer 2	Veneer 3	OW	OD	OH	

Overhead Cabinets, Top without Profile Edge Detail (Double High)

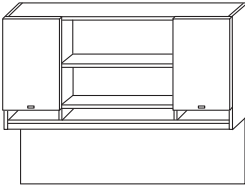

FA64M2-PWP	3 yds	4589	4956	5506	72	15 3/4	56	195
-------------------	-------	-------------	-------------	-------------	----	--------	----	-----

Veneer species must be noted on each line item

Wall mount, flush top without profile edge detail, fabric tack panel (fabric not included, COM must be acrylic backed). Open center storage, one adjustable shelf, open project shelf storage 3" high. Cabinet back unfinished. Optional task lights available, see HBF Casegood Accessories.

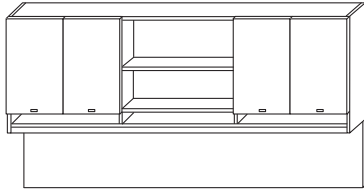

FA64N2-PWP	3 yds	5279	5701	6335	78	15 3/4	56	215
FA64P2-PWP	3 yds	5526	5968	6631	84	15 3/4	56	215
FA64R2-PWP	3 yds	5773	6235	6928	90	15 3/4	56	225
FA64S2-PWP	3 1/4 yds	6010	6491	7212	96	15 3/4	56	225
FA64T2-PWP	3 1/2 yds	6268	6769	7521	102	15 3/4	56	235
FA64U2-PWP	3 3/4 yds	6515	7036	7818	108	15 3/4	56	235
FA64V2-PWP	4 1/4 yds	6752	7292	8102	114	15 3/4	56	245
FA64W2-PWP	4 1/4 yds	6989	7548	8386	120	15 3/4	56	245

Veneer species must be noted on each line item

Wall mount, flush top without profile edge detail, fabric tack panel (fabric not included, COM must be acrylic backed). Open center storage, one adjustable shelf, open project shelf storage 3" high. Cabinet back unfinished. Optional task lights available, see HBF Casegood Accessories.

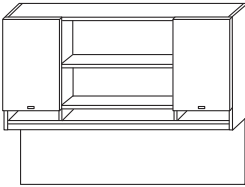

FA65M2-PWP		4898	5289	5877	72	15 3/4	56	195
-------------------	--	-------------	-------------	-------------	----	--------	----	-----

Veneer species must be noted on each line item

Wall mount, flush top without profile edge detail, finished wood panel. Open center storage, one adjustable shelf, open project shelf storage 3" high. Cabinet back unfinished. Optional task lights available, see HBF Casegood Accessories.

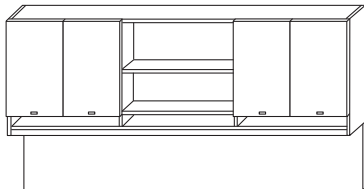

FA65N2-PWP		5619	6068	6742	78	15 3/4	56	215
FA65P2-PWP		5897	6368	7076	84	15 3/4	56	215
FA65R2-PWP		6144	6635	7373	90	15 3/4	56	225
FA65S2-PWP		6412	6925	7694	96	15 3/4	56	225
FA65T2-PWP		6690	7225	8028	102	15 3/4	56	235
FA65U2-PWP		6937	7492	8324	108	15 3/4	56	235
FA65V2-PWP		7174	7748	8609	114	15 3/4	56	245
FA65W2-PWP		7411	8004	8893	120	15 3/4	56	245

Veneer species must be noted on each line item

Wall mount, flush top without profile edge detail, finished wood panel. Open center storage, one adjustable shelf, open project shelf storage 3" high. Cabinet back unfinished. Optional task lights available, see HBF Casegood Accessories.

**Double high overhead cabinets to be used with double high vertical cabinets.
Installation and maintenance of wall mounted overhead cabinets are the sole responsibility of the customer.
Proper installation is crucial to prevent personal injury.**

Veneer species must be noted on each line item

<u>Veneer Grade 1</u>	<u>Veneer Grade 2</u>	<u>Veneer Grade 3</u>
Cherry	Rift Oak	Anigre
Maple	Sapele	
Ligno-Grain		
Walnut		

HBF Fairmont Casegoods - Overhead Cabinets

Style Number	Fabric	List Price			Dimensions			Weight
		Veneer 1	Veneer 2	Veneer 3	OW	OD	OH	

Overhead Cabinets, Top with Profile Edge Detail

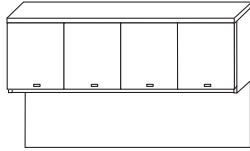

FA64A-FNP	3 yds	3610	3899	4332	72	15 3/4	43 5/8	205
------------------	-------	-------------	-------------	-------------	----	--------	--------	-----

Veneer species must be noted on each line item

Wall mount, top with profile edge detail, fabric tack panel (fabric not included, COM must be acrylic backed), cabinet back unfinished. Optional task lights available, see HBF Casegood Accessories.

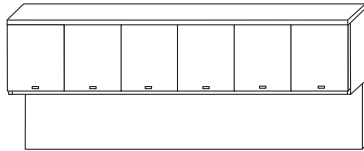

FA64F-FNP	3 yds	4156	4489	4987	78	15 3/4	43 5/8	225
FA64B-FNP	3 yds	4362	4711	5234	84	15 3/4	43 5/8	225
FA64C-FNP	3 yds	4558	4922	5469	90	15 3/4	43 5/8	235
FA64D-FNP	3 1/4 yds	4743	5123	5692	96	15 3/4	43 5/8	235
FA64G-FNP	3 1/2 yds	4949	5345	5939	102	15 3/4	43 5/8	245
FA64E-FNP	3 3/4 yds	5145	5556	6174	108	15 3/4	43 5/8	245
FA64H-FNP	4 1/4 yds	5330	5757	6396	114	15 3/4	43 5/8	255
FA64J-FNP	4 1/4 yds	5516	5957	6619	120	15 3/4	43 5/8	255

Veneer species must be noted on each line item

Wall mount, top with profile edge detail, fabric tack panel (fabric not included, COM must be acrylic backed), cabinet back unfinished. Optional task lights available, see HBF Casegood Accessories.

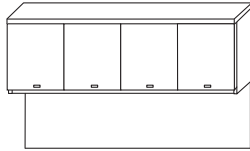

FA65A-FNP		3857	4166	4629	72	15 3/4	43 5/8	205
------------------	--	-------------	-------------	-------------	----	--------	--------	-----

Veneer species must be noted on each line item

Wall mount, top with profile edge detail, finished wood panel, cabinet back unfinished. Optional task lights available, see HBF Casegood Accessories.

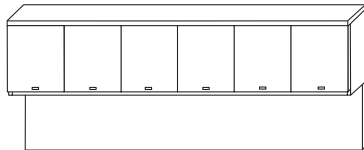

FA65F-FNP		4434	4789	5321	78	15 3/4	43 5/8	225
FA65B-FNP		4650	5022	5581	84	15 3/4	43 5/8	225
FA65C-FNP		4856	5245	5828	90	15 3/4	43 5/8	235
FA65D-FNP		5062	5467	6075	96	15 3/4	43 5/8	235
FA65G-FNP		5289	5712	6347	102	15 3/4	43 5/8	245
FA65E-FNP		5485	5924	6582	108	15 3/4	43 5/8	245
FA65H-FNP		5670	6124	6804	114	15 3/4	43 5/8	255
FA65J-FNP		5856	6324	7027	120	15 3/4	43 5/8	255

Veneer species must be noted on each line item

Wall mount, top with profile edge detail, finished wood panel, cabinet back unfinished. Optional task lights available, see HBF Casegood Accessories.

Installation and maintenance of wall mounted overhead cabinets are the sole responsibility of the customer. Proper installation is crucial to prevent personal injury.

Veneer species must be noted on each line item

<u>Veneer Grade 1</u>	<u>Veneer Grade 2</u>	<u>Veneer Grade 3</u>
Cherry	Rift Oak	Anigre
Maple	Sapele	
Ligno-Grain		
Walnut		

HBF Fairmont Casegoods - Overhead Cabinets

Style Number	Fabric	List Price			Dimensions			Weight
		Veneer 1	Veneer 2	Veneer 3	OW	OD	OH	

Overhead Cabinets, Top with Profile Edge Detail

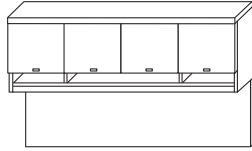

FA64A-FWP	3 yds	3991	4311	4790	72	15 3/4	43 5/8	205
------------------	-------	-------------	-------------	-------------	----	--------	--------	-----

Veneer species must be noted on each line item

Wall mount, top with profile edge detail, fabric tack panel (fabric not included, COM must be acrylic backed). Open project shelf storage 3" high. Cabinet back unfinished. Optional task lights available, see HBF Casegood Accessories.

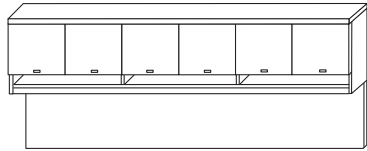

FA64F-FWP	3 yds	4599	4967	5519	78	15 3/4	43 5/8	225
FA64B-FWP	3 yds	4815	5200	5778	84	15 3/4	43 5/8	225
FA64C-FWP	3 yds	5032	5434	6038	90	15 3/4	43 5/8	235
FA64D-FWP	3 1/4 yds	5238	5657	6285	96	15 3/4	43 5/8	235
FA64G-FWP	3 1/2 yds	5464	5901	6557	102	15 3/4	43 5/8	245
FA64E-FWP	3 3/4 yds	5680	6135	6817	108	15 3/4	43 5/8	245
FA64H-FWP	4 1/4 yds	5866	6335	7039	114	15 3/4	43 5/8	255
FA64J-FWP	4 1/4 yds	6051	6535	7262	120	15 3/4	43 5/8	255

Veneer species must be noted on each line item

Wall mount, top with profile edge detail, fabric tack panel (fabric not included, COM must be acrylic backed). Open project shelf storage 3" high. Cabinet back unfinished. Optional task lights available, see HBF Casegood Accessories.

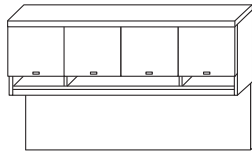

FA65A-FWP		4269	4611	5123	72	15 3/4	43 5/8	205
------------------	--	-------------	-------------	-------------	----	--------	--------	-----

Veneer species must be noted on each line item

Wall mount, top with profile edge detail, finished wood panel. Open project shelf storage 3" high. Cabinet back unfinished. Optional task lights available, see HBF Casegood Accessories.

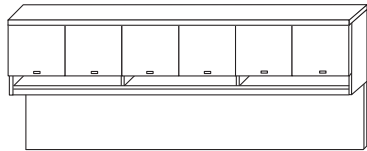

FA65F-FWP		4898	5289	5877	78	15 3/4	43 5/8	225
FA65B-FWP		5145	5556	6174	84	15 3/4	43 5/8	225
FA65C-FWP		5361	5790	6433	90	15 3/4	43 5/8	235
FA65D-FWP		5588	6035	6705	96	15 3/4	43 5/8	235
FA65G-FWP		5835	6302	7002	102	15 3/4	43 5/8	245
FA65E-FWP		6051	6535	7262	108	15 3/4	43 5/8	245
FA65H-FWP		6237	6736	7484	114	15 3/4	43 5/8	255
FA65J-FWP		6422	6936	7706	120	15 3/4	43 5/8	255

Veneer species must be noted on each line item

Wall mount, top with profile edge detail, finished wood panel. Open project shelf storage 3" high. Cabinet back unfinished. Optional task lights available, see HBF Casegood Accessories.

**Installation and maintenance of wall mounted overhead cabinets are the sole responsibility of the customer.
Proper installation is crucial to prevent personal injury.**

Veneer species must be noted on each line item

<u>Veneer Grade 1</u>	<u>Veneer Grade 2</u>	<u>Veneer Grade 3</u>
Cherry	Rift Oak	Anigre
Maple	Sapele	
Ligno-Grain		
Walnut		

HBF Fairmont Casegoods - Overhead Cabinets

Style Number	Fabric	List Price			Dimensions			Weight
		Veneer 1	Veneer 2	Veneer 3	OW	OD	OH	

Overhead Cabinets, Top with Profile Edge Detail

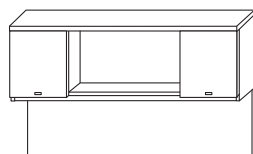

FA64A-PNP	3 yds	3425	3699	4110	72	15 3/4	43 5/8	200
------------------	-------	-------------	-------------	-------------	----	--------	--------	-----

Veneer species must be noted on each line item

Wall mount, top with profile edge detail, fabric tack panel (fabric not included, COM must be acrylic backed). Open center storage. Cabinet back unfinished. Optional task lights available, see HBF Casegood Accessories.

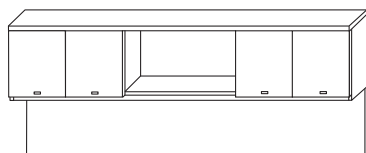

FA64F-PNP	3 yds	3940	4255	4728	78	15 3/4	43 5/8	215
FA64B-PNP	3 yds	4135	4466	4963	84	15 3/4	43 5/8	215
FA64C-PNP	3 yds	4321	4667	5185	90	15 3/4	43 5/8	225
FA64D-PNP	3 1/4 yds	4496	4856	5395	96	15 3/4	43 5/8	225
FA64G-PNP	3 1/2 yds	4692	5067	5630	102	15 3/4	43 5/8	235
FA64E-PNP	3 3/4 yds	4877	5267	5852	108	15 3/4	43 5/8	235
FA64H-PNP	4 1/4 yds	5062	5467	6075	114	15 3/4	43 5/8	245
FA64J-PNP	4 1/4 yds	5248	5668	6297	120	15 3/4	43 5/8	245

Veneer species must be noted on each line item

Wall mount, top with profile edge detail, fabric tack panel (fabric not included, COM must be acrylic backed). Open center storage. Cabinet back unfinished. Optional task lights available, see HBF Casegood Accessories.

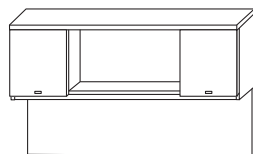

FA65A-PNP		3662	3955	4394	72	15 3/4	43 5/8	200
------------------	--	-------------	-------------	-------------	----	--------	--------	-----

Veneer species must be noted on each line item

Wall mount, top with profile edge detail, finished wood panel. Open center storage. Cabinet back unfinished. Optional task lights available, see HBF Casegood Accessories.

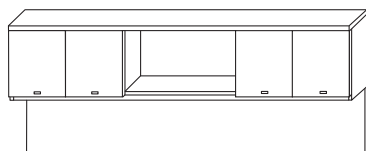

FA65F-PNP		4197	4533	5037	78	15 3/4	43 5/8	215
FA65B-PNP		4414	4767	5296	84	15 3/4	43 5/8	215
FA65C-PNP		4599	4967	5519	90	15 3/4	43 5/8	225
FA65D-PNP		4805	5189	5766	96	15 3/4	43 5/8	225
FA65G-PNP		5011	5412	6013	102	15 3/4	43 5/8	235
FA65E-PNP		5196	5612	6236	108	15 3/4	43 5/8	235
FA65H-PNP		5382	5812	6458	114	15 3/4	43 5/8	245
FA65J-PNP		5567	6013	6681	120	15 3/4	43 5/8	245

Veneer species must be noted on each line item

Wall mount, top with profile edge detail, finished wood panel. Open center storage. Cabinet back unfinished. Optional task lights available, see HBF Casegood Accessories.

**Installation and maintenance of wall mounted overhead cabinets are the sole responsibility of the customer.
Proper installation is crucial to prevent personal injury.**

Veneer species must be noted on each line item

<u>Veneer Grade 1</u>	<u>Veneer Grade 2</u>	<u>Veneer Grade 3</u>
Cherry	Rift Oak	Anigre
Maple	Sapele	
Ligno-Grain		
Walnut		

HBF Fairmont Casegoods - Overhead Cabinets

Style Number	Fabric	List Price			Dimensions			Weight
		Veneer 1	Veneer 2	Veneer 3	OW	OD	OH	

Overhead Cabinets, Top with Profile Edge Detail

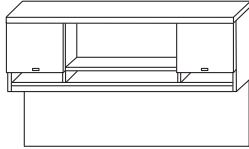

FA64A-PWP	3 yds	3806	4110	4567	72	15 3/4	43 5/8	200
------------------	-------	-------------	-------------	-------------	----	--------	--------	-----

Veneer species must be noted on each line item

Wall mount, top with profile edge detail, fabric tack panel (fabric not included, COM must be acrylic backed). Open project shelf storage 3" high and open center storage. Cabinet back unfinished. Optional task lights available, see HBF Casegood Accessories.

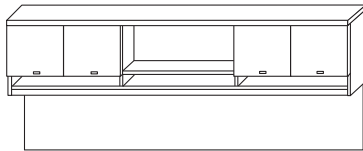

FA64F-PWP	3 yds	4372	4722	5247	78	15 3/4	43 5/8	215
FA64B-PWP	3 yds	4589	4956	5506	84	15 3/4	43 5/8	215
FA64C-PWP	3 yds	4795	5178	5754	90	15 3/4	43 5/8	225
FA64D-PWP	3 1/4 yds	5001	5401	6001	96	15 3/4	43 5/8	225
FA64G-PWP	3 1/2 yds	5207	5623	6248	102	15 3/4	43 5/8	235
FA64E-PWP	3 3/4 yds	5413	5846	6495	108	15 3/4	43 5/8	235
FA64H-PWP	4 1/4 yds	5598	6046	6718	114	15 3/4	43 5/8	245
FA64J-PWP	4 1/4 yds	5783	6246	6940	120	15 3/4	43 5/8	245

Veneer species must be noted on each line item

Wall mount, top with profile edge detail, fabric tack panel (fabric not included, COM must be acrylic backed). Open project shelf storage 3" high and open center storage. Cabinet back unfinished. Optional task lights available, see HBF Casegood Accessories.

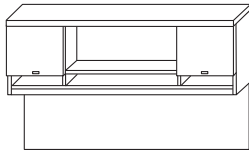

FA65A-PWP		4063	4388	4876	72	15 3/4	43 5/8	200
------------------	--	-------------	-------------	-------------	----	--------	--------	-----

Veneer species must be noted on each line item

Wall mount, top with profile edge detail, finished wood panel). Open project shelf storage 3" high and open center storage. Cabinet back unfinished. Optional task lights available, see HBF Casegood Accessories.

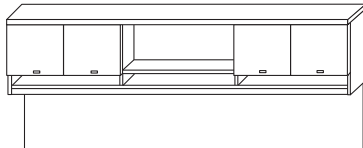

FA65F-PWP		4661	5034	5593	78	15 3/4	43 5/8	215
FA65B-PWP		4898	5289	5877	84	15 3/4	43 5/8	215
FA65C-PWP		5104	5512	6124	90	15 3/4	43 5/8	225
FA65D-PWP		5330	5757	6396	96	15 3/4	43 5/8	225
FA65G-PWP		5557	6001	6668	102	15 3/4	43 5/8	235
FA65E-PWP		5763	6224	6915	108	15 3/4	43 5/8	235
FA65H-PWP		5948	6424	7138	114	15 3/4	43 5/8	245
FA65J-PWP		6134	6624	7360	120	15 3/4	43 5/8	245

Veneer species must be noted on each line item

Wall mount, top with profile edge detail, finished wood panel). Open project shelf storage 3" high and open center storage. Cabinet back unfinished. Optional task lights available, see HBF Casegood Accessories.

Installation and maintenance of wall mounted overhead cabinets are the sole responsibility of the customer. Proper installation is crucial to prevent personal injury.

Veneer species must be noted on each line item

<u>Veneer Grade 1</u>	<u>Veneer Grade 2</u>	<u>Veneer Grade 3</u>
Cherry	Rift Oak	Anigre
Maple	Sapele	
Ligno-Grain		
Walnut		

HBF Fairmont Casegoods - Overhead Cabinets

Style Number	Fabric	List Price			Dimensions			Weight
		Veneer 1	Veneer 2	Veneer 3	OW	OD	OH	

Overhead Cabinets, Top with Profile Edge Detail (Double High)

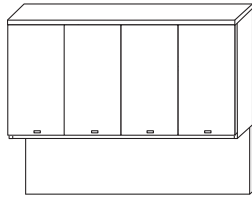

FA64A2-FNP	3 yds	4949	5345	5939	72	15 3/4	57 3/8	210
-------------------	-------	-------------	-------------	-------------	----	--------	--------	-----

Veneer species must be noted on each line item

Wall mount, top with profile edge detail, one adjustable shelf, fabric tack panel (fabric not included, COM must be acrylic backed), cabinet back unfinished. Optional task lights available, see HBF Casegood Accessories.

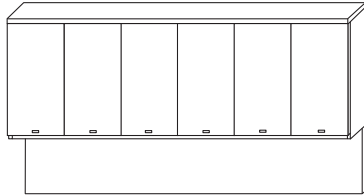

FA64F2-FNP	3 yds	5691	6146	6829	78	15 3/4	57 3/8	230
FA64B2-FNP	3 yds	5969	6446	7163	84	15 3/4	57 3/8	230
FA64C2-FNP	3 yds	6226	6724	7472	90	15 3/4	57 3/8	240
FA64D2-FNP	3 1/4 yds	6484	7003	7781	96	15 3/4	57 3/8	240
FA64G2-FNP	3 1/2 yds	6762	7303	8114	102	15 3/4	57 3/8	250
FA64E2-FNP	3 3/4 yds	7019	7581	8423	108	15 3/4	57 3/8	250
FA64H2-FNP	4 1/4 yds	7256	7837	8708	114	15 3/4	57 3/8	260
FA64J2-FNP	4 1/4 yds	7493	8093	8992	120	15 3/4	57 3/8	260

Veneer species must be noted on each line item

Wall mount, top with profile edge detail, one adjustable shelf, fabric tack panel (fabric not included, COM must be acrylic backed), cabinet back unfinished. Optional task lights available, see HBF Casegood Accessories.

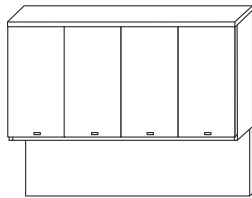

FA65A2-FNP		5289	5712	6347	72	15 3/4	57 3/8	210
-------------------	--	-------------	-------------	-------------	----	--------	--------	-----

Veneer species must be noted on each line item

Wall mount, top with profile edge detail, one adjustable shelf, finished wood panel, cabinet back unfinished. Optional task lights available, see HBF Casegood Accessories.

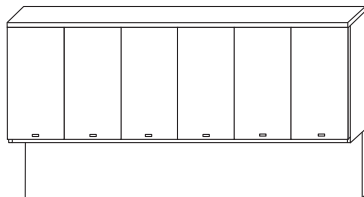

FA65F2-FNP		6062	6546	7274	78	15 3/4	57 3/8	230
FA65B2-FNP		6360	6869	7632	84	15 3/4	57 3/8	230
FA65C2-FNP		6628	7158	7954	90	15 3/4	57 3/8	240
FA65D2-FNP		6916	7470	8300	96	15 3/4	57 3/8	240
FA65G2-FNP		7215	7792	8658	102	15 3/4	57 3/8	250
FA65E2-FNP		7483	8082	8980	108	15 3/4	57 3/8	250
FA65H2-FNP		7720	8337	9264	114	15 3/4	57 3/8	260
FA65J2-FNP		7957	8593	9548	120	15 3/4	57 3/8	260

Veneer species must be noted on each line item

Wall mount, top with profile edge detail, one adjustable shelf, finished wood panel, cabinet back unfinished. Optional task lights available, see HBF Casegood Accessories.

**Double high overhead cabinets to be used with double high vertical cabinets.
Installation and maintenance of wall mounted overhead cabinets are the sole responsibility of the customer.
Proper installation is crucial to prevent personal injury.**

Veneer species must be noted on each line item

<u>Veneer Grade 1</u>	<u>Veneer Grade 2</u>	<u>Veneer Grade 3</u>
Cherry	Rift Oak	Anigre
Maple	Sapele	
Ligno-Grain		
Walnut		

HBF Fairmont Casegoods - Overhead Cabinets

Style Number	Fabric	List Price			Dimensions			Weight
		Veneer 1	Veneer 2	Veneer 3	OW	OD	OH	

Overhead Cabinets, Top with Profile Edge Detail (Double High)

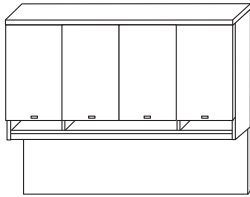

FA64A2-FWP	3 yds	5464	5901	6557	72	15 3/4	57 3/8	210
-------------------	-------	-------------	-------------	-------------	----	--------	--------	-----

Veneer species must be noted on each line item

Wall mount, top with profile edge detail, one adjustable shelf, fabric tack panel (fabric not included, COM must be acrylic backed). Open project shelf storage 3" high. Cabinet back unfinished. Optional task lights available, see HBF Casegood Accessories.

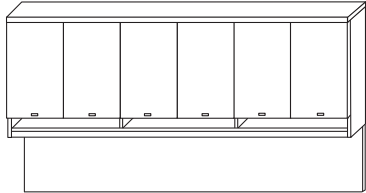

FA64F2-FWP	3 yds	6278	6780	7533	78	15 3/4	57 3/8	230
FA64B2-FWP	3 yds	6587	7114	7904	84	15 3/4	57 3/8	230
FA64C2-FWP	3 yds	6875	7425	8250	90	15 3/4	57 3/8	240
FA64D2-FWP	3 1/4 yds	7153	7726	8584	96	15 3/4	57 3/8	240
FA64G2-FWP	3 1/2 yds	7462	8059	8955	102	15 3/4	57 3/8	250
FA64E2-FWP	3 3/4 yds	7740	8360	9289	108	15 3/4	57 3/8	250
FA64H2-FWP	4 1/4 yds	7977	8616	9573	114	15 3/4	57 3/8	260
FA64J2-FWP	4 1/4 yds	8214	8871	9857	120	15 3/4	57 3/8	260

Veneer species must be noted on each line item

Wall mount, top with profile edge detail, one adjustable shelf, fabric tack panel (fabric not included, COM must be acrylic backed). Open project shelf storage 3" high. Cabinet back unfinished. Optional task lights available, see HBF Casegood Accessories.

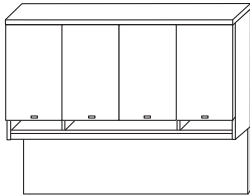

FA65A2-FWP		5845	6313	7014	72	15 3/4	57 3/8	210
-------------------	--	-------------	-------------	-------------	----	--------	--------	-----

Veneer species must be noted on each line item

Wall mount, top with profile edge detail, one adjustable shelf, finished wood panel. Open project shelf storage 3" high. Cabinet back unfinished. Optional task lights available, see HBF Casegood Accessories.

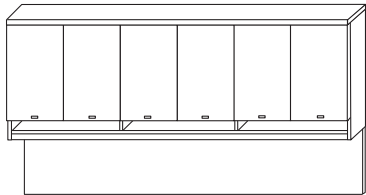

FA65F2-FWP		6690	7225	8028	78	15 3/4	57 3/8	230
FA65B2-FWP		7019	7581	8423	84	15 3/4	57 3/8	230
FA65C2-FWP		7308	7892	8769	90	15 3/4	57 3/8	240
FA65D2-FWP		7627	8237	9153	96	15 3/4	57 3/8	240
FA65G2-FWP		7957	8593	9548	102	15 3/4	57 3/8	250
FA65E2-FWP		8255	8916	9907	108	15 3/4	57 3/8	250
FA65H2-FWP		8492	9172	10191	114	15 3/4	57 3/8	260
FA65J2-FWP		8729	9428	10475	120	15 3/4	57 3/8	260

Veneer species must be noted on each line item

Wall mount, top with profile edge detail, one adjustable shelf, finished wood panel. Open project shelf storage 3" high. Cabinet back unfinished. Optional task lights available, see HBF Casegood Accessories.

**Double high overhead cabinets to be used with double high vertical cabinets.
Installation and maintenance of wall mounted overhead cabinets are the sole responsibility of the customer.
Proper installation is crucial to prevent personal injury.**

Veneer species must be noted on each line item

Veneer Grade 1	Veneer Grade 2	Veneer Grade 3
Cherry	Rift Oak	Anigre
Maple	Sapele	
Ligno-Grain		
Walnut		

HBF Fairmont Casegoods - Overhead Cabinets

Style Number	Fabric	List Price			Dimensions			Weight
		Veneer 1	Veneer 2	Veneer 3	OW	OD	OH	

Overhead Cabinets, Top with Profile Edge Detail (Double High)

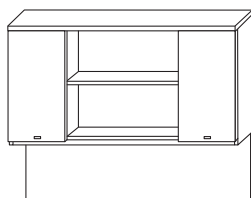

FA64A2-PNP	3 yds	4692	5067	5630	72	15 3/4	57 3/8	200
-------------------	-------	-------------	-------------	-------------	----	--------	--------	-----

Veneer species must be noted on each line item

Wall mount, top with profile edge detail, fabric tack panel (fabric not included, COM must be acrylic backed). Open center storage, one adjustable shelf. Cabinet back unfinished. Optional task lights available, see HBF Casegood Accessories.

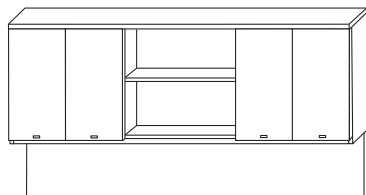

FA64F2-PNP	3 yds	5392	5823	6470	78	15 3/4	57 3/8	220
FA64B2-PNP	3 yds	5660	6113	6792	84	15 3/4	57 3/8	220
FA64C2-PNP	3 yds	5907	6380	7088	90	15 3/4	57 3/8	230
FA64D2-PNP	3 1/4 yds	6154	6647	7385	96	15 3/4	57 3/8	230
FA64G2-PNP	3 1/2 yds	6412	6925	7694	102	15 3/4	57 3/8	240
FA64E2-PNP	3 3/4 yds	6659	7192	7991	108	15 3/4	57 3/8	240
FA64H2-PNP	4 1/4 yds	6896	7448	8275	114	15 3/4	57 3/8	250
FA64J2-PNP	4 1/4 yds	7133	7703	8559	120	15 3/4	57 3/8	250

Veneer species must be noted on each line item

Wall mount, top with profile edge detail, fabric tack panel (fabric not included, COM must be acrylic backed). Open center storage, one adjustable shelf. Cabinet back unfinished. Optional task lights available, see HBF Casegood Accessories.

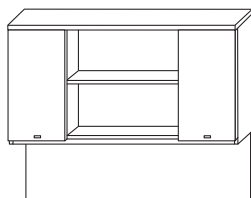

FA65A2-PNP		5021	5423	6026	72	15 3/4	57 3/8	200
-------------------	--	-------------	-------------	-------------	----	--------	--------	-----

Veneer species must be noted on each line item

Wall mount, top with profile edge detail, finished wood panel. Open center storage, one adjustable shelf. Cabinet back unfinished. Optional task lights available, see HBF Casegood Accessories.

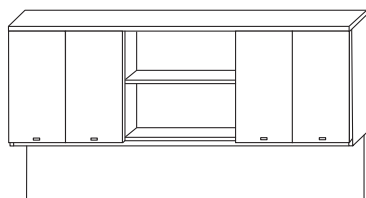

FA65F2-PNP		5753	6213	6903	78	15 3/4	57 3/8	220
FA65B2-PNP		6031	6513	7237	84	15 3/4	57 3/8	220
FA65C2-PNP		6288	6791	7546	90	15 3/4	57 3/8	230
FA65D2-PNP		6556	7080	7867	96	15 3/4	57 3/8	230
FA65G2-PNP		6844	7392	8213	102	15 3/4	57 3/8	240
FA65E2-PNP		7102	7670	8522	108	15 3/4	57 3/8	240
FA65H2-PNP		7339	7926	8807	114	15 3/4	57 3/8	250
FA65J2-PNP		7576	8182	9091	120	15 3/4	57 3/8	250

Veneer species must be noted on each line item

Wall mount, top with profile edge detail, finished wood panel. Open center storage, one adjustable shelf. Cabinet back unfinished. Optional task lights available, see HBF Casegood Accessories.

**Double high overhead cabinets to be used with double high vertical cabinets.
Installation and maintenance of wall mounted overhead cabinets are the sole responsibility of the customer.
Proper installation is crucial to prevent personal injury.**

Veneer species must be noted on each line item

<u>Veneer Grade 1</u>	<u>Veneer Grade 2</u>	<u>Veneer Grade 3</u>
Cherry	Rift Oak	Anigre
Maple	Sapele	
Ligno-Grain		
Walnut		

HBF Fairmont Casegoods - Overhead Cabinets

Style Number	Fabric	List Price			Dimensions			Weight
		Veneer 1	Veneer 2	Veneer 3	OW	OD	OH	

Overhead Cabinets, Top with Profile Edge Detail, (Double High)

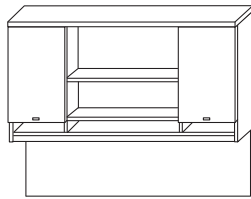

FA64A2-PWP	3 yds	5207	5623	6248	72	15 3/4	57 3/8	200
-------------------	-------	-------------	-------------	-------------	----	--------	--------	-----

Veneer species must be noted on each line item

Wall mount, top with profile edge detail, fabric tack panel (fabric not included, COM must be acrylic backed). Open center storage, one adjustable shelf, open project shelf storage 3" high. Cabinet back unfinished. Optional task lights available, see HBF Casegood Accessories.

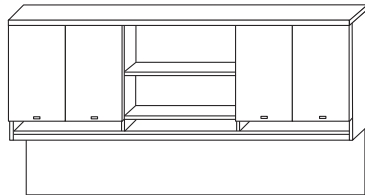

FA64F2-PWP	3 yds	5989	6469	7187	78	15 3/4	57 3/8	220
FA64B2-PWP	3 yds	6278	6780	7533	84	15 3/4	57 3/8	220
FA64C2-PWP	3 yds	6546	7069	7855	90	15 3/4	57 3/8	230
FA64D2-PWP	3 1/4 yds	6824	7370	8189	96	15 3/4	57 3/8	230
FA64G2-PWP	3 1/2 yds	7112	7681	8535	102	15 3/4	57 3/8	240
FA64E2-PWP	3 3/4 yds	7380	7970	8856	108	15 3/4	57 3/8	240
FA64H2-PWP	4 1/4 yds	7617	8226	9140	114	15 3/4	57 3/8	250
FA64J2-PWP	4 1/4 yds	7854	8482	9425	120	15 3/4	57 3/8	250

Veneer species must be noted on each line item

Wall mount, top with profile edge detail, fabric tack panel (fabric not included, COM must be acrylic backed). Open center storage, one adjustable shelf, open project shelf storage 3" high. Cabinet back unfinished. Optional task lights available, see HBF Casegood Accessories.

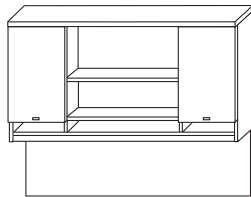

FA65A2-PWP		5567	6013	6681	72	15 3/4	57 3/8	200
-------------------	--	-------------	-------------	-------------	----	--------	--------	-----

Veneer species must be noted on each line item

Wall mount, top with profile edge detail, finished wood panel. Open center storage, one adjustable shelf, open project shelf storage 3" high. Cabinet back unfinished. Optional task lights available, see HBF Casegood Accessories.

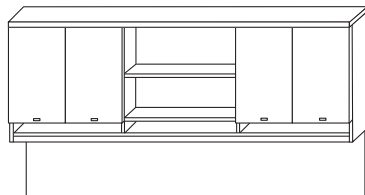

FA65F2-PWP		6371	6880	7645	78	15 3/4	57 3/8	220
FA65B2-PWP		6690	7225	8028	84	15 3/4	57 3/8	220
FA65C2-PWP		6968	7525	8362	90	15 3/4	57 3/8	230
FA65D2-PWP		7267	7848	8720	96	15 3/4	57 3/8	230
FA65G2-PWP		7586	8193	9103	102	15 3/4	57 3/8	240
FA65E2-PWP		7864	8493	9437	108	15 3/4	57 3/8	240
FA65H2-PWP		8101	8749	9721	114	15 3/4	57 3/8	250
FA65J2-PWP		8338	9005	10005	120	15 3/4	57 3/8	250

Veneer species must be noted on each line item

Wall mount, top with profile edge detail, finished wood panel. Open center storage, one adjustable shelf, open project shelf storage 3" high. Cabinet back unfinished. Optional task lights available, see HBF Casegood Accessories.

**Double high overhead cabinets to be used with double high vertical cabinets.
Installation and maintenance of wall mounted overhead cabinets are the sole responsibility of the customer.
Proper installation is crucial to prevent personal injury.**

Veneer species must be noted on each line item

<u>Veneer Grade 1</u>	<u>Veneer Grade 2</u>	<u>Veneer Grade 3</u>
Cherry	Rift Oak	Anigre
Maple	Sapele	
Ligno-Grain		
Walnut		

HBF Fairmont Casegoods - Vertical Storage

Style Number	List Price			Dimensions				Weight
	Veneer 1	Veneer 2	Veneer 3	OW	OD	OH:M	OH:A/F	

Vertical Storage Cabinets, Top without Profile Edge Detail

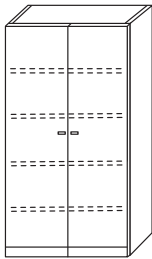

FA70M	3291	3554	3949	30	24 3/4	71 1/2	71	205
FA70N	3435	3710	4122	36	24 3/4	71 1/2	71	237

Veneer species must be noted on each line item

Storage unit, four adjustable shelves, flush top without profile edge detail, cabinet back unfinished.

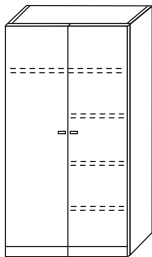

FA71M	3517	3799	4221	30	24 3/4	71 1/2	71	205
FA71N	3651	3943	4382	36	24 3/4	71 1/2	71	237

Veneer species must be noted on each line item

Storage/wardrobe unit, four adjustable shelves and a hat shelf with wardrobe rod, shelves are field changeable from left to right, flush top without profile edge detail, cabinet back unfinished.

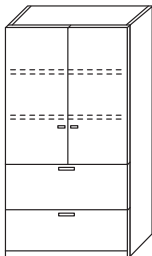

FA72M	4032	4355	4839	30	24 3/4	71 1/2	71	205
FA72N	4156	4489	4987	36	24 3/4	71 1/2	71	237

Veneer species must be noted on each line item

Storage unit, two adjustable shelves above and two locking lateral file drawers below. Flush top without profile edge detail, cabinet back unfinished.

Fairmont units have two (2) pulls per lateral file drawer.

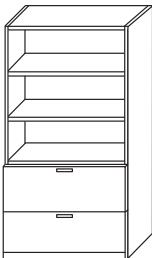

FA73M	3723	4021	4468	30	24 3/4	71 1/2	71	205
FA73N	3868	4177	4641	36	24 3/4	71 1/2	71	237

Veneer species must be noted on each line item

Storage unit, two open adjustable shelves above and two locking lateral file drawers below. Flush top without profile edge detail, cabinet back unfinished.

Fairmont units have two (2) pulls per lateral file drawer.

Veneer species must be noted on each line item

<u>Veneer Grade 1</u>	<u>Veneer Grade 2</u>	<u>Veneer Grade 3</u>
Cherry	Rift Oak	Anigre
Maple	Sapele	
Ligno-Grain		
Walnut		

HBF Fairmont Casegoods - Vertical Storage

Style Number		List Price			Dimensions				Weight
		Veneer 1	Veneer 2	Veneer 3	OW	OD	OH:M	OH:A/F	

Vertical Storage Cabinets, Top without Profile Edge Detail

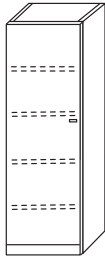

FALH70P	(left hinge)	2724	2942	3269	18	24 3/4	71 1/2	71	176
FARH70P	(right hinge)	2724	2942	3269	18	24 3/4	71 1/2	71	176

Veneer species must be noted on each line item

Storage unit, four adjustable shelves. Flush top without profile edge detail, cabinet back unfinished.

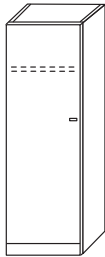

FALH71P	(left hinge)	2518	2720	3022	18	24 3/4	71 1/2	71	176
FARH71P	(right hinge)	2518	2720	3022	18	24 3/4	71 1/2	71	176

Veneer species must be noted on each line item

Wardrobe unit, hat shelf and wardrobe rod. Flush top without profile edge detail, cabinet back unfinished.

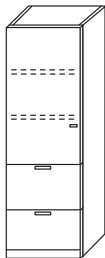

FALH72P	(left hinge)	3342	3610	4011	18	24 3/4	71 1/2	71	176
FARH72P	(right hinge)	3342	3610	4011	18	24 3/4	71 1/2	71	176

Veneer species must be noted on each line item

Storage unit, two adjustable shelves above and two locking file drawers below. Flush top without profile edge detail, cabinet back unfinished.



FA73P		2879	3109	3455	18	24 3/4	71 1/2	71	176
--------------	--	-------------	-------------	-------------	----	--------	--------	----	-----

Veneer species must be noted on each line item

Storage unit, two open adjustable shelves above and two locking file drawers below. Flush top without profile edge detail, cabinet back unfinished.

Veneer species must be noted on each line item

<u>Veneer Grade 1</u>	<u>Veneer Grade 2</u>	<u>Veneer Grade 3</u>
Cherry	Rift Oak	Anigre
Maple	Sapele	
Ligno-Grain		
Walnut		

HBF Fairmont Casegoods - Vertical Storage

Style Number	List Price			Dimensions				Weight
	Veneer 1	Veneer 2	Veneer 3	OW	OD	OH:M	OH:A/F	

Vertical Storage Cabinets, Top with Profile Edge Detail

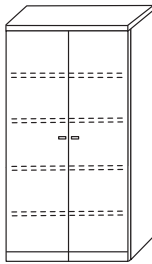

FA70A	3744	4044	4493	30	24 3/4	73	72 1/4	205
FA70B	3940	4255	4728	36	24 3/4	73	72 1/4	237

Veneer species must be noted on each line item

Storage unit, four adjustable shelves. Top with profile edge detail, cabinet back unfinished.

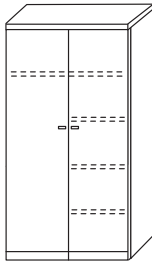

FA71A	3971	4288	4765	30	24 3/4	73	72 1/4	205
FA71B	4166	4500	5000	36	24 3/4	73	72 1/4	237

Veneer species must be noted on each line item

Storage/Wardrobe unit, four adjustable shelves and a hat shelf with wardrobe rod, shelves are field changeable left to right. Top with profile edge detail, cabinet back unfinished.

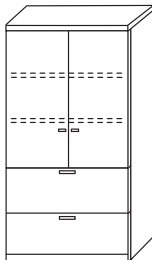

FA72A	4496	4856	5395	30	24 3/4	73	72 1/4	205
FA72B	4681	5056	5618	36	24 3/4	73	72 1/4	237

Veneer species must be noted on each line item

Storage unit, two adjustable shelves above and two locking lateral file drawers below. Top with profile edge detail, cabinet back unfinished.

Fairmont units have two (2) pulls per lateral file drawer.

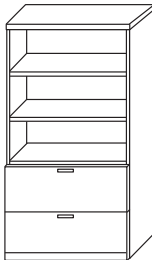

FA73A	4187	4522	5024	30	24 3/4	73	72 1/4	205
FA73B	4383	4733	5259	36	24 3/4	73	72 1/4	237

Veneer species must be noted on each line item

Storage unit, two open adjustable shelves above and two locking lateral file drawers below. Top with profile edge detail, cabinet back unfinished.

Fairmont units have two (2) pulls per lateral file drawer.

Veneer species must be noted on each line item

<u>Veneer Grade 1</u>	<u>Veneer Grade 2</u>	<u>Veneer Grade 3</u>
Cherry	Rift Oak	Anigre
Maple	Sapele	
Ligno-Grain		
Walnut		

HBF Fairmont Casegoods - Vertical Storage

Style Number		List Price			Dimensions				
		Veneer 1	Veneer 2	Veneer 3	OW	OD	OH:M	OH:A/F	Weight

Vertical Storage Cabinets, Top with Profile Edge Detail

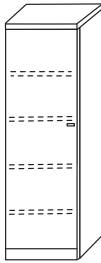

FALH70C	(left hinge)	3105	3354	3727	18	24 3/4	73	72 1/4	176
FARH70C	(right hinge)	3105	3354	3727	18	24 3/4	73	72 1/4	176

Veneer species must be noted on each line item

Storage unit, four adjustable shelves. Top with profile edge detail, cabinet back unfinished.

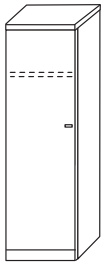

FALH71C	(left hinge)	2889	3120	3467	18	24 3/4	73	72 1/4	176
FARH71C	(right hinge)	2889	3120	3467	18	24 3/4	73	72 1/4	176

Veneer species must be noted on each line item

Wardrobe unit, hat shelf and wardrobe rod. Top with profile edge detail, cabinet back unfinished.

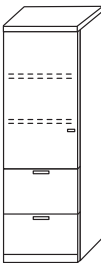

FALH72C	(left hinge)	3734	4032	4481	18	24 3/4	73	72 1/4	176
FARH72C	(right hinge)	3734	4032	4481	18	24 3/4	73	72 1/4	176

Veneer species must be noted on each line item

Storage unit, two adjustable shelves above and two locking file drawers below. Top with profile edge detail, cabinet back unfinished.



FA73C		3239	3498	3887	18	24 3/4	73	72 1/4	176
-------	--	------	------	------	----	--------	----	--------	-----

Veneer species must be noted on each line item

Storage unit, two open adjustable shelves above and two locking file drawers below. Top with profile edge detail, cabinet back unfinished.

Veneer species must be noted on each line item

Veneer Grade 1	Veneer Grade 2	Veneer Grade 3
Cherry	Rift Oak	Anigre
Maple	Sapele	
Ligno-Grain		
Walnut		

HBF Fairmont Casegoods - Vertical Storage

Style Number	List Price			Dimensions				Weight
	Veneer 1	Veneer 2	Veneer 3	OW	OD	OH:M	OH:A/F	

Vertical Storage Cabinets, Top without Profile Edge Detail (Double High)

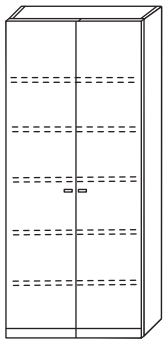

FA70M2	4455	4811	5346	30	24 3/4	85 5/16	84 11/16	277
FA70N2	4650	5022	5581	36	24 3/4	85 5/16	84 11/16	320

Veneer species must be noted on each line item

Storage unit, five adjustable shelves, flush top without profile edge detail, cabinet back unfinished.

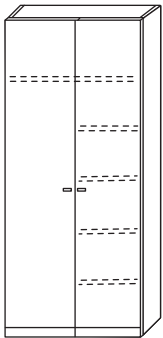

FA71M2	(left hinge)	4753	5134	5704	30	24 3/4	85 5/16	84 11/16	277
FA71N2	(right hinge)	4939	5334	5927	36	24 3/4	85 5/16	84 11/16	320

Veneer species must be noted on each line item

Storage/wardrobe unit, five adjustable shelves and a hat shelf with wardrobe rod, shelves are field changeable from left to right, flush top without profile edge detail, cabinet back unfinished.

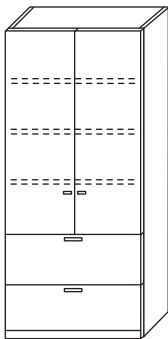

FA72M2	5444	5879	6532	30	24 3/4	85 5/16	84 11/16	277
FA72N2	5619	6068	6742	36	24 3/4	85 5/16	84 11/16	320

Veneer species must be noted on each line item

Storage unit, three adjustable shelves above and two locking lateral file drawers below. Flush top without profile edge detail, cabinet back unfinished.

Fairmont units have two (2) pulls per lateral file drawer.



FA73M2	5032	5434	6038	30	24 3/4	85 5/16	84 11/16	277
FA73N2	5227	5645	6273	36	24 3/4	85 5/16	84 11/16	320

Veneer species must be noted on each line item

Storage unit, three open adjustable shelves above and two locking lateral file drawers below. Flush top without profile edge detail, cabinet back unfinished.

Fairmont units have two (2) pulls per lateral file drawer.

Veneer species must be noted on each line item

Veneer Grade 1	Veneer Grade 2	Veneer Grade 3
Cherry	Rift Oak	Anigre
Maple	Sapele	
Ligno-Grain		
Walnut		

HBF Fairmont Casegoods - Vertical Storage

Style Number		List Price			Dimensions				Weight
		Veneer 1	Veneer 2	Veneer 3	OW	OD	OH:M	OH:A/F	

Vertical Storage Cabinets, Top without Profile Edge Detail (Double High)

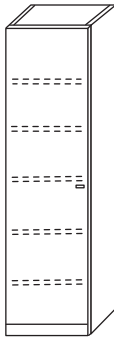

FALH70P2	(left hinge)	3672	3966	4406	18	24 3/4	85 5/16	84 11/16	237
FARH70P2	(right hinge)	3672	3966	4406	18	24 3/4	85 5/16	84 11/16	237

Veneer species must be noted on each line item

Storage unit, five adjustable shelves. Flush top without profile edge detail, cabinet back unfinished.

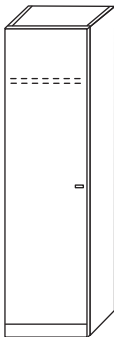

FALH71P2	(left hinge)	3414	3688	4097	18	24 3/4	85 5/16	84 11/16	237
FARH71P2	(right hinge)	3414	3688	4097	18	24 3/4	85 5/16	84 11/16	237

Veneer species must be noted on each line item

Wardrobe unit, hat shelf and wardrobe rod. Flush top without profile edge detail, cabinet back unfinished.

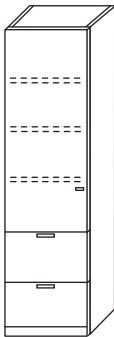

FALH72P2	(left hinge)	4517	4878	5420	18	24 3/4	85 5/16	84 11/16	237
FARH72P2	(right hinge)	4517	4878	5420	18	24 3/4	85 5/16	84 11/16	237

Veneer species must be noted on each line item

Storage unit, three adjustable shelves above and two locking file drawers below. Flush top without profile edge detail, cabinet back unfinished.

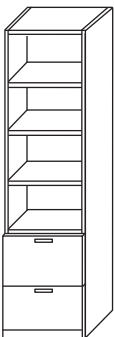

FA73P2		3868	4177	4641	18	24 3/4	85 5/16	84 11/16	237
---------------	--	-------------	-------------	-------------	----	--------	---------	----------	-----

Veneer species must be noted on each line item

Storage unit, three open adjustable shelves above and two locking file drawers below. Flush top without profile edge detail, cabinet back unfinished.

Veneer species must be noted on each line item

<u>Veneer Grade 1</u>	<u>Veneer Grade 2</u>	<u>Veneer Grade 3</u>
Cherry	Rift Oak	Anigre
Maple	Sapele	
Ligno-Grain		
Walnut		

HBF Fairmont Casegoods - Vertical Storage

Style Number	List Price			Dimensions				Weight
	Veneer 1	Veneer 2	Veneer 3	OW	OD	OH:M	OH:A/F	

Vertical Storage Cabinets, Top with Profile Edge Detail (Double High)

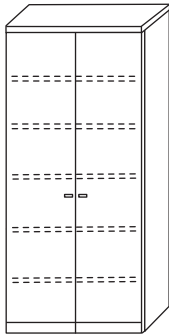

FA70A2	5021	5423	6026	30	24 3/4	86 11/16	86 1/16	277
FA70B2	5320	5746	6384	36	24 3/4	86 11/16	86 1/16	320

Veneer species must be noted on each line item

Storage unit, five adjustable shelves. Top with profile edge detail, cabinet back unfinished.

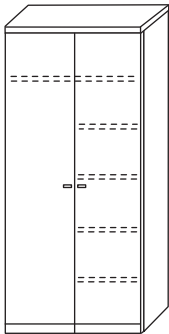

FA71A2	5371	5801	6446	30	24 3/4	86 11/16	86 1/16	277
FA71B2	5629	6079	6755	36	24 3/4	86 11/16	86 1/16	320

Veneer species must be noted on each line item

Storage/Wardrobe unit, five adjustable shelves and a hat shelf with wardrobe rod, shelves are field changeable left to right. Top with profile edge detail, cabinet back unfinished.

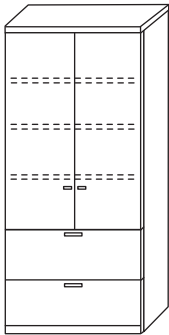

FA72A2	6072	6558	7286	30	24 3/4	86 11/16	86 1/16	277
FA72B2	6319	6825	7583	36	24 3/4	86 11/16	86 1/16	320

Veneer species must be noted on each line item

Storage unit, three adjustable shelves above and two locking lateral file drawers below. Top with profile edge detail, cabinet back unfinished.

Fairmont units have two (2) pulls per lateral file drawer.



FA73A2	5660	6113	6792	30	24 3/4	86 11/16	86 1/16	277
FA73B2	5917	6391	7101	36	24 3/4	86 11/16	86 1/16	320

Veneer species must be noted on each line item

Storage unit, three open adjustable shelves above and two locking lateral file drawers below. Top with profile edge detail, cabinet back unfinished.

Fairmont units have two (2) pulls per lateral file drawer.

Veneer species must be noted on each line item

Veneer Grade 1	Veneer Grade 2	Veneer Grade 3
Cherry	Rift Oak	Anigre
Maple	Sapele	
Ligno-Grain		
Walnut		

HBF Fairmont Casegoods - Vertical Storage

Style Number	List Price			Dimensions				Weight
	Veneer 1	Veneer 2	Veneer 3	OW	OD	OH:M	OH:A/F	

Vertical Storage Cabinets, Top with Profile Edge Detail (Double High)

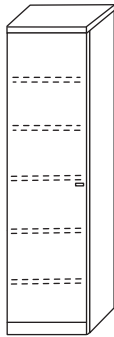

FALH70C2	(left hinge)	4187	4522	5024	18	24 3/4	86 11/16	86 1/16	237
FARH70C2	(right hinge)	4187	4522	5024	18	24 3/4	86 11/16	86 1/16	237

Veneer species must be noted on each line item

Storage unit, five adjustable shelves. Top with profile edge detail, cabinet back unfinished.

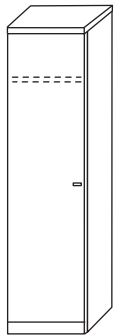

FALH71C2	(left hinge)	3899	4210	4678	18	24 3/4	86 11/16	86 1/16	237
FARH71C2	(right hinge)	3899	4210	4678	18	24 3/4	86 11/16	86 1/16	237

Veneer species must be noted on each line item

Wardrobe unit, hat shelf and wardrobe rod. Top with profile edge detail, cabinet back unfinished.

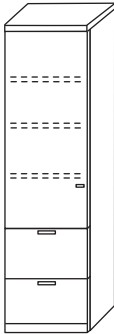

FALH72C2	(left hinge)	5042	5445	6050	18	24 3/4	86 11/16	86 1/16	237
FARH72C2	(right hinge)	5042	5445	6050	18	24 3/4	86 11/16	86 1/16	237

Veneer species must be noted on each line item

Storage unit, three adjustable shelves above and two locking file drawers below. Top with profile edge detail, cabinet back unfinished.

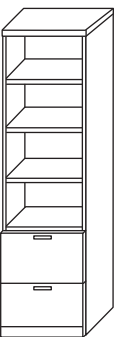

FA73C2		4383	4733	5259	18	24 3/4	86 11/16	86 1/16	237
---------------	--	-------------	-------------	-------------	----	--------	----------	---------	-----

Veneer species must be noted on each line item

Storage unit, three open adjustable shelves above and two locking file drawers below. Top with profile edge detail, cabinet back unfinished.

Veneer species must be noted on each line item

<u>Veneer Grade 1</u>	<u>Veneer Grade 2</u>	<u>Veneer Grade 3</u>
Cherry	Rift Oak	Anigre
Maple	Sapele	
Ligno-Grain		
Walnut		

HBF Fairmont Casegoods - Bookcases

Style Number	List Price			Dimensions					
	Veneer 1	Veneer 2	Veneer 3	OW	OD	OH:M	OH:A/F	Weight	

Bookcases

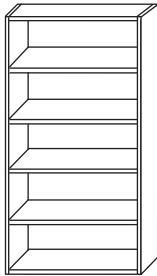

FA75MB	2941	3176	3529	30	14 7/8	71 1/2	71	195
FA75NB	3002	3242	3602	36	14 7/8	71 1/2	71	227

Veneer species must be noted on each line item

Flush top without profile edge detail, four adjustable shelves, standard black unfinished back panel.

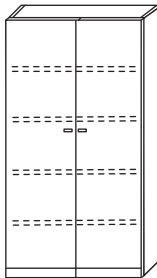

FA76MB	3167	3421	3801	30	15 3/4	71 1/2	71	205
FA76NB	3291	3554	3949	36	15 3/4	71 1/2	71	237

Veneer species must be noted on each line item

Flush top without profile edge detail, four adjustable shelves, standard black unfinished back panel.

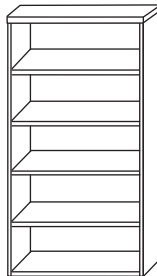

FA75AB	3281	3543	3937	30	14 7/8	73	72 1/4	195
FA75BB	3384	3654	4060	36	14 7/8	73	72 1/4	227

Veneer species must be noted on each line item

Top with profile edge detail, four adjustable shelves, standard black unfinished back panel.

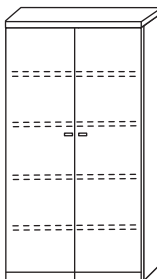

FA76AB	3517	3799	4221	30	15 3/4	73	72 1/4	205
FA76BB	3682	3977	4419	36	15 3/4	73	72 1/4	237

Veneer species must be noted on each line item

Top with profile edge detail, four adjustable shelves, standard black unfinished back panel.

Veneer species must be noted on each line item

Veneer Grade 1	Veneer Grade 2	Veneer Grade 3
Cherry	Rift Oak	Anigre
Maple	Sapele	
Ligno-Grain		
Walnut		

HBF Fairmont Casegoods - Bookcases

Style Number	List Price			Dimensions				Weight
	Veneer 1	Veneer 2	Veneer 3	OW	OD	OH:M	OH:A/F	

Bookcases (Double High)

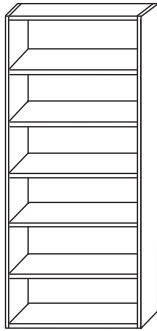

FA75MB2	3981	4299	4777	30	14 7/8	85 5/16	84 11/16	264
FA75NB2	4053	4377	4864	36	14 7/8	85 5/16	84 11/16	307

Veneer species must be noted on each line item

Flush top without profile edge detail, five adjustable shelves, standard black unfinished back panel.

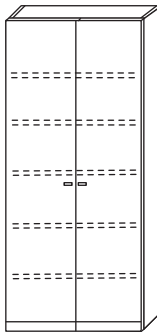

FA76MB2	4280	4622	5136	30	15 3/4	85 5/16	84 11/16	277
FA76NB2	4455	4811	5346	36	15 3/4	85 5/16	84 11/16	320

Veneer species must be noted on each line item

Flush top without profile edge detail, five adjustable shelves, standard black unfinished back panel.

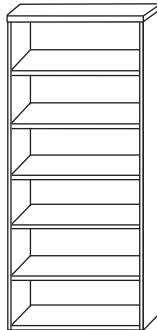

FA75AB2	4424	4778	5309	30	14 7/8	86 11/16	86 1/16	264
FA75BB2	4568	4933	5482	36	14 7/8	86 11/16	86 1/16	307

Veneer species must be noted on each line item

Top with profile edge detail, five adjustable shelves, standard black unfinished back panel.

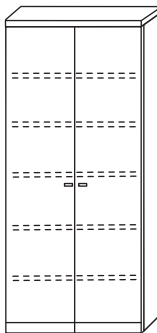

FA76AB2	4753	5134	5704	30	15 3/4	86 11/16	86 1/16	277
FA76BB2	4980	5378	5976	36	15 3/4	86 11/16	86 1/16	320

Veneer species must be noted on each line item

Top with profile edge detail, five adjustable shelves, standard black unfinished back panel.

Veneer species must be noted on each line item

Veneer Grade 1	Veneer Grade 2	Veneer Grade 3
Cherry	Rift Oak	Anigre
Maple	Sapele	
Ligno-Grain		
Walnut		

HBF Fairmont Casegoods - Bookcases

Style Number	List Price			Dimensions				Weight
	Veneer 1	Veneer 2	Veneer 3	OW	OD	OH:M	OH:A/F	

Bookcases

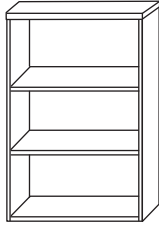

FA75A	2673	2887	3207	30	14 7/8	44	43 3/8	109
FA75B	2838	3065	3405	36	14 7/8	44	43 3/8	131

Veneer species must be noted on each line item

Top profile edge detail, two adjustable shelves, standard black unfinished back.

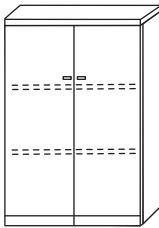

FA76A	3208	3465	3850	30	15 3/4	44	43 3/8	109
FA76B	3363	3632	4036	36	15 3/4	44	43 3/8	131

Veneer species must be noted on each line item

Top profile edge detail, two adjustable shelves, standard black unfinished back.

Lateral Files

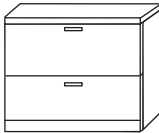

FA37A	2323	2508	2787	30	24	29	29	180
FA37B	2415	2609	2898	36	24	29	29	192
FA37B3	3734	4032	4481	36	24	42 1/4	42 1/4	205
FA37B4	4197	4533	5037	36	24	55 3/4	55 3/4	230
FA38A	2930	3165	3516	30	24 3/4	29	29	182
FA38B	3023	3265	3628	36	24 3/4	29	29	192
FA38B3	4341	4689	5210	36	24 3/4	42 1/4	42 1/4	207
FA38B4	4805	5189	5766	36	24 3/4	55 3/4	55 3/4	232

Veneer species must be noted on each line item

37 lateral files have a standard black unfinished back panel.

38 lateral files have a finished back panel.

37B3 and 38B3 are three high lateral files.

37B4 and 38B4 are four high lateral files.

Fairmont units have two (2) pulls per lateral file drawer.

Veneer species must be noted on each line item

Veneer Grade 1	Veneer Grade 2	Veneer Grade 3
Cherry	Rift Oak	Anigre
Maple	Sapele	
Ligno-Grain		
Walnut		

HBF Fairmont Casegoods - Reception Desks

Style Number	List Price			Dimensions			Weight
	Veneer 1	Veneer 2	Veneer 3	OW	OD	OH	

Rectangular Reception Desks, Recessed Modesty Panel

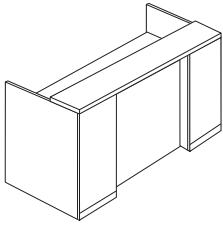

FA81A	9265	10006	11118	72	35	41 3/8	569
FA81B	10182	10996	12218	84	35	41 3/8	589

Veneer species must be noted on each line item

Transaction shelf. 11" OH from bottom of transaction shelf to top of worksurface. Worksurface recessed 1 1/4" from modesty panel to provide access for wire management, grommets not required in desk. One desk pedestal and location (right or left) must be specified. Pedestals must be 18" box/box/file or 18" file/file.

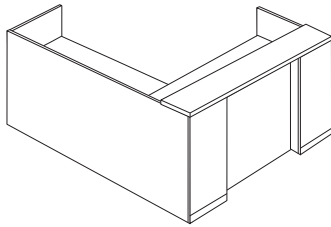

FA82A	10666	11519	12799	72	84 3/8	41 3/8	869
FA82B	11582	12509	13899	84	84 3/8	41 3/8	890

Veneer species must be noted on each line item

Transaction shelf, desk only. 11" OH from bottom of transaction shelf to top of worksurface. Worksurface recessed 1 1/4" from modesty panel to provide access for wire management, grommets not required in desk. One desk pedestal and one return pedestal, along with hand of return, must be specified. Pedestals must be 18" box/box/file or 18" file/file.

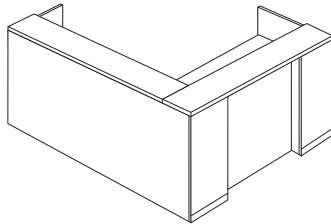

FA83A	11016	11897	13219	72	84 3/8	41 3/8	915
FA83B	11974	12932	14369	84	84 3/8	41 3/8	935

Veneer species must be noted on each line item

Transaction shelf, desk and return. 11" OH from bottom of transaction shelf to top of worksurface. Worksurface recessed 1 1/4" from modesty panel to provide access for wire management, grommets not required in desk. One desk pedestal and one return pedestal, along with hand of return, must be specified. Pedestals must be 18" box/box/file or 18" file/file.

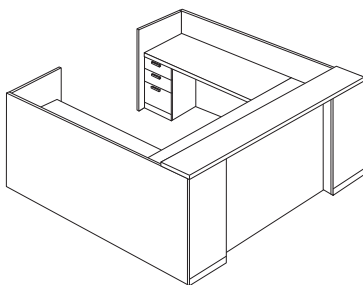

FA87C	13488	14567	16185	90	84 3/8	41 3/8	910
--------------	--------------	--------------	--------------	----	--------	--------	-----

Veneer species must be noted on each line item

Transaction shelf, desk only. 11" OH from bottom of transaction shelf to top of worksurface. Worksurface recessed 1 1/4" from modesty panel to provide access for wire management, grommets not required in desk. Both left and right return pedestals must be specified. Pedestals must be 18" box/box/file or 18" file/file.

Veneer species must be noted on each line item

<u>Veneer Grade 1</u>	<u>Veneer Grade 2</u>	<u>Veneer Grade 3</u>
Cherry	Rift Oak	Anigre
Maple	Sapele	
Ligno-Grain		
Walnut		

HBF Fairmont Casegoods - Reception Desks

Style Number	List Price			Dimensions			Weight
	Veneer 1	Veneer 2	Veneer 3	OW	OD	OH	

Rectangular Reception Desks, Recessed Modesty Panel

FA88C	14281	15423	17137	90	84 3/8	41 3/8	955
--------------	--------------	--------------	--------------	----	--------	--------	-----

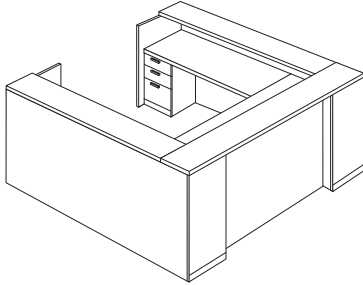

Veneer species must be noted on each line item

Transaction shelf, desk and both returns. 11" OH from bottom of transaction shelf to top of worksurface. Worksurface recessed 1 1/4" from modesty panel to provide access for wire management, grommets not required in desk. Both left and right return pedestals must be specified. Pedestals must be 18" box/box/file or 18" file/file.

FA87AR	14168	15301	17001	72	107	41 3/8	1289
FA87BR	14992	16191	17990	84	107	41 3/8	1319

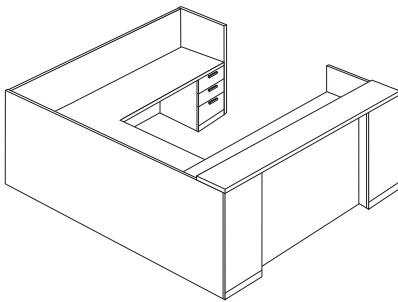

Veneer species must be noted on each line item

Transaction shelf, desk only. 11" OH from bottom of transaction shelf to top of worksurface. Worksurface recessed 1 1/4" from modesty panel to provide access for wire management, grommets not required in desk. Desk and credenza pedestal along with hand of bridge must be specified. Pedestals must be 18" box/box/file or 18" file/file.

FA88AR	14528	15690	17434	72	107	41 5/8	1335
FA88BR	15352	16580	18423	84	107	41 5/8	1385

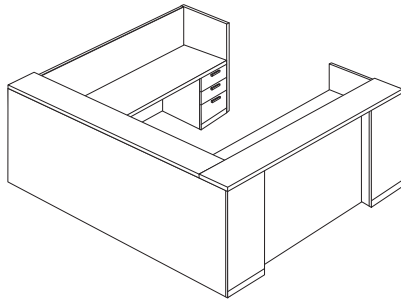

Veneer species must be noted on each line item

Transaction shelf, desk and return. 11" OH from bottom of transaction shelf to top of worksurface. Worksurface recessed 1 1/4" from modesty panel to provide access for wire management, grommets not required in desk. Desk and credenza pedestal along with hand of bridge must be specified. Pedestals must be 18" box/box/file or 18" file/file.

Bow Front Reception Desks, Recessed Modesty Panel

FA84A	10583	11430	12700	72	39	41 3/8	569
FA84B	11531	12453	13837	84	39	41 3/8	589

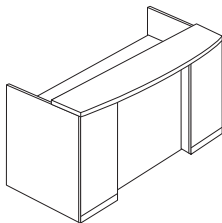

Veneer species must be noted on each line item

Transaction shelf. 11" OH from bottom of transaction shelf to top of worksurface. Worksurface recessed 1 1/4" from modesty panel to provide access for wire management, grommets not required in desk. Desk pedestal and location (left or right) must be specified. Pedestals must be 18" box/box/file or 18" file/file.

Veneer species must be noted on each line item

<u>Veneer Grade 1</u>	<u>Veneer Grade 2</u>	<u>Veneer Grade 3</u>
Cherry	Rift Oak	Anigre
Maple	Sapele	
Ligno-Grain		
Walnut		

HBF Fairmont Casegoods - Reception Desks

Style Number	List Price			Dimensions			Weight
	Veneer 1	Veneer 2	Veneer 3	OW	OD	OH	

Bow Front Reception Desks, Recessed Modesty Panel

FA85A	11974	12932	14369	72	88 3/8	41 3/8	869
FA85B	12890	13922	15469	84	88 3/8	41 3/8	890

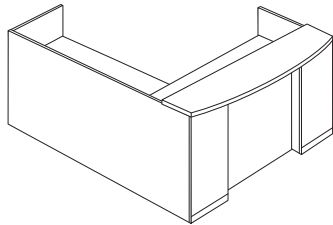

Veneer species must be noted on each line item

Transaction shelf, desk only. 11" OH from bottom of transaction shelf to top of worksurface. Worksurface recessed 1 1/4" from modesty panel to provide access for wire management, grommets not required in desk. One desk pedestal and one return pedestal, along with hand of return, must be specified. Pedestals must be 18" box/box/file or 18" file/file.

FA86A	12386	13377	14863	72	88 3/8	41 3/8	915
FA86B	13282	14344	15938	84	88 3/8	41 3/8	935

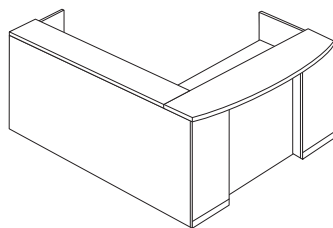

Veneer species must be noted on each line item

Transaction shelf, desk and return. 11" OH from bottom of transaction shelf to top of worksurface. Worksurface recessed 1 1/4" from modesty panel to provide access for wire management, grommets not required in desk. One desk pedestal and one return pedestal, along with hand of return, must be specified. Pedestals must be 18" box/box/file or 18" file/file.

Rectangular Reception Desks, Recessed Modesty Panel

FA89C	14786	15969	17743	90	88 3/8	41 3/8	910
--------------	--------------	--------------	--------------	----	--------	--------	-----

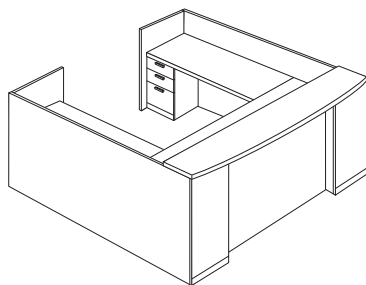

Veneer species must be noted on each line item

Transaction shelf, desk only. 11" OH from bottom of transaction shelf to top of worksurface. Worksurface recessed 1 1/4" from modesty panel to provide access for wire management, grommets not required in desk. Both left and right return pedestals must be specified. Pedestals must be 18" box/box/file or 18" file/file.

FA90C	15599	16847	18719	90	88 3/8	41 3/8	955
--------------	--------------	--------------	--------------	----	--------	--------	-----

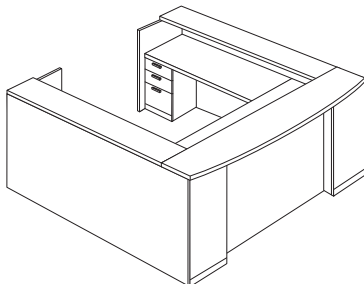

Veneer species must be noted on each line item

Transaction shelf, desk and both returns. 11" OH from bottom of transaction shelf to top of worksurface. Worksurface recessed 1 1/4" from modesty panel to provide access for wire management, grommets not required in desk. Both left and right return pedestals must be specified. Pedestals must be 18" box/box/file or 18" file/file.

Veneer species must be noted on each line item

<u>Veneer Grade 1</u>	<u>Veneer Grade 2</u>	<u>Veneer Grade 3</u>
Cherry	Rift Oak	Anigre
Maple	Sapele	
Ligno-Grain		
Walnut		

HBF Fairmont Casegoods - Reception Desks

Style Number	List Price			Dimensions			Weight
	Veneer 1	Veneer 2	Veneer 3	OW	OD	OH	

Rectangular Reception Desks, Recessed Modesty Panel

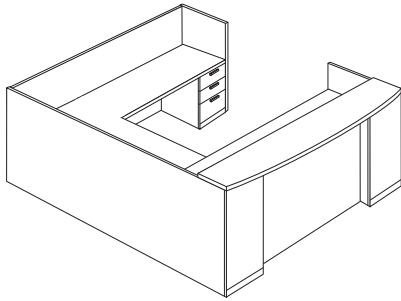

FA90AR	15527	16769	18633	72	111	41 3/8	1289
FA90BR	15960	17237	19152	84	111	41 3/8	1319

Veneer species must be noted on each line item

Transaction shelf, desk only. 11" OH from bottom of transaction shelf to top of worksurface. Worksurface recessed 1 1/4" from modesty panel to provide access for wire management, grommets not required in desk. Desk and credenza pedestal, along with hand of bridge, must be specified. Pedestals must be 18" box/box/file or 18" file/file.

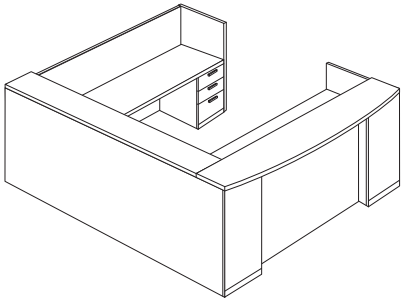

FA91AR	15888	17159	19065	72	111	41 3/8	1335
FA91BR	16320	17626	19584	84	111	41 3/8	1385

Veneer species must be noted on each line item

Transaction shelf, desk and return. 11" OH from bottom of transaction shelf to top of worksurface. Worksurface recessed 1 1/4" from modesty panel to provide access for wire management, grommets not required in desk. Desk and credenza pedestal, along with hand of bridge, must be specified. Pedestals must be 18" box/box/file or 18" file/file.

Veneer species must be noted on each line item

<u>Veneer Grade 1</u>	<u>Veneer Grade 2</u>	<u>Veneer Grade 3</u>
Cherry	Rift Oak	Anigre
Maple	Sapele	
Ligno-Grain		
Walnut		

HBF Fairmont Accessories

Style Number	List Price			Dimensions			Weight
	Veneer 1	Veneer 2	Veneer 3	OW	OD	OH	

Stack Shelves

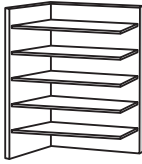

AC97A (S or B)	510			17 1/4	11 1/4	22	10
AC97B (S or B)	561			18	11 1/4	22	12

Indicate S for Satin Pewter powder coat shelves, B for Gloss Black powder coat shelves. Inside back and end are wood veneer panels and will be finished to match the casegood unit; outside back and end panels are standard black unfinished. AC97A is intended to be used with overhead cabinets with wood panel support; AC97B is used with wall mount overhead cabinets.

Worksurface Shelves



AC97C (S or B)-36	438			36	9 1/4	3 1/4	24
AC97C (S or B)-42	438			42	9 1/4	3 1/4	25
AC97C (S or B)-48	438			48	9 1/4	3 1/4	26
AC97C (S or B)-54	438			54	9 1/4	3 1/4	28
AC97C (S or B)-60	489			60	9 1/4	3 1/4	30
AC97C (S or B)-66	489			66	9 1/4	3 1/4	31
AC97C (S or B)-72	489			72	9 1/4	3 1/4	32
AC97C (S or B)-78	561			78	9 1/4	3 1/4	34
AC97C (S or B)-84	561			84	9 1/4	3 1/4	36
AC97C (S or B)-90	561			90	9 1/4	3 1/4	38
AC97C (S or B)-96	561			96	9 1/4	3 1/4	40
AC97C (S or B)-102	613			102	9 1/4	3 1/4	42
AC97C (S or B)-108	613			108	9 1/4	3 1/4	44
AC97C (S or B)-114	613			114	9 1/4	3 1/4	46
AC97C (S or B)-120	613			120	9 1/4	3 1/4	48

Indicate S for Satin Pewter powder coat shelves, B for Gloss Black powder coat shelves. Shelf supports are Gloss Black powder coat.

Pedestal Shelves (Set of Four)

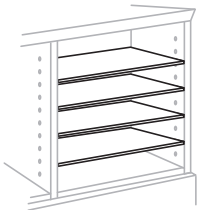

AC97D (S or B)-18	149			16 1/2	11 1/8		
AC97D (S or B)-30	149			13 7/8	11 1/8		
AC97D (S or B)-36	149			16 7/8	11 1/8		

Indicate S for Satin Pewter powder coat shelves, B for Gloss Black powder coat shelves.

Pedestal Dividers (Set of Three)

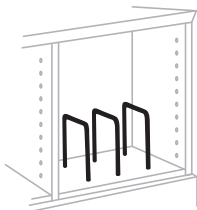

AC97E	36					6 1/4	
-------	----	--	--	--	--	-------	--

Metal wire dividers are Satin Nickel finish.

Veneer species must be noted on each line item

Veneer Grade 1	Veneer Grade 2	Veneer Grade 3
Cherry	Rift Oak	Anigre
Maple	Sapele	
Ligno-Grain		
Walnut		

HBF Fairmont Conference Table Specifications

Tables with Wood Bases

Veneer Premium grade flat cut veneer tops. Edges are bordered with veneer solids or edgebands.

Top Edge Detail

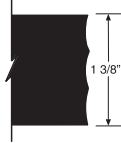

Worksurfaces Fairmont conference tables have a 1 3/8" (35mm) thick top.

Base Options

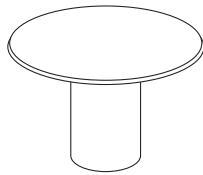

**Wood Column Base
Round**

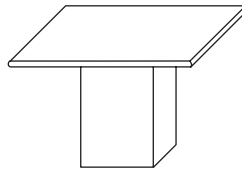

**Wood Column Base
Square**

Round and Square Tables with Single Wood Base

Round Metal Grommet Power/Data Plate

Fairmont Conference Tables with single wood bases are available with a compact power/data unit with a removable grommet cover. The round grommet is standard in HBF Satin Pewter powder coat finish. Grommet mounts flush with the top surface.

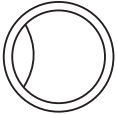

Tables specifying power/data capabilities will be equipped with a power/data unit that provides two (2) 110 volt electrical outlets and two (2) Cat.5E data jacks. This unit is hardwired and must be installed by a licensed electrician. Bases for tables with power/data access incorporate a hinged wood door on the side of the base to allow access to floor connections.



The electrical components provided within this group of furniture are engineered and manufactured in compliance with NEC regulation, however ***it is the responsibility of the specifier and contracted installer of the furniture to be aware of the local building and electrical restrictions.*** Electrical components meet both Chicago and New York electrical codes.

Additional voice/data inserts are available to replace the standard data jacks. These inserts can be ordered from Doug Mockett & Company (www.mockett.com) and installed as required by the end user's data specialist to accommodate specific requirements.

HBF Fairmont Conference Table Specifications

Rectangular, Boat and Elliptical Tables with Multiple Wood Bases

Round Metal Grommet Power/Data Plate

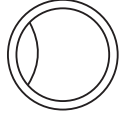

Fairmont Conference Tables with multiple wood bases are available with either a round or oval grommet and power/data access units. Bases for tables with power/data access incorporate a hinged wood door on the side of the base to allow access to floor connections.

The removable round grommet is standard in HBF Satin Pewter powder coat finish and mounts flush with the top surface. The power/data unit provides two (2) 110 volt electrical outlets and two (2) Cat.5E data jacks. This unit is hardwired and must be installed by a licensed electrician.



The hinged oval grommet is standard in HBF Satin Pewter powder coat finish and mounts flush with the top surface. The power/data unit provides four (4) 110 volt electrical outlets and six (6) Cat.5E data jacks. This unit is hardwired and must be installed by a licensed electrician.

The electrical components provided within this group of furniture are engineered and manufactured in compliance with NEC regulation, however **it is the responsibility of the specifier and contracted installer of the furniture to be aware of the local building and electrical restrictions.** Electrical components meet both Chicago and New York electrical codes.

Oval Metal Grommet Power/Data Plate

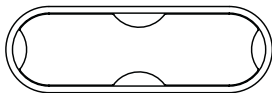

Additional voice/data inserts are available to replace the standard data jacks. These inserts can be ordered from Doug Mockett & Company (www.mockett.com) and installed as required by the end user's data specialist to accommodate specific requirements.

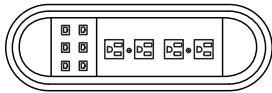

Pedestal Bases

Round and square pedestal bases for tables specifying power/data access incorporate a hinged wood door to provide easy access to the inside of the base.

Wood Column Base Placement

Note: In style numbers "Y" equals a round base, "I" equals a square base.

Wood Column Base Placement Locations						
Table Dimension	Top Size Designation		A	B	C	D
	Non-electrical	Electrical				
48" x 96"	E	S	15"	30"	(2) 18"	15"
48" x 108"	F	G	15"	42"	(2) 18"	15"
48" x 120"	G	V	15"	54"	(2) 18"	15"
54" x 120" ellipse	G	V	15"	(2) 25"	(2) 18"	18"
54" x 144"	H	W	17"	(2) 25"	(2) 18" / (1) 24"	15" / 18"
54" / 60" x 168"	J	X	18"	(2) 27"	(2) 24" / (1) 30"	12" / 15"
54" / 60" x 192"	K	Y	21"	(2) 36"	(2) 24" / (1) 30"	12" / 15"
60" x 216"	L	Z	27"	(2) 42"	(2) 24" / (1) 30"	15" / 18"

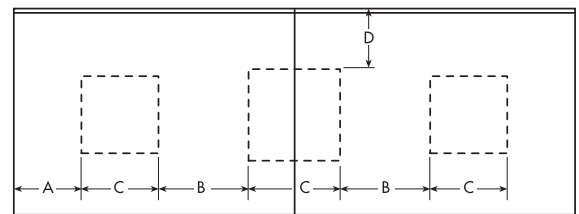
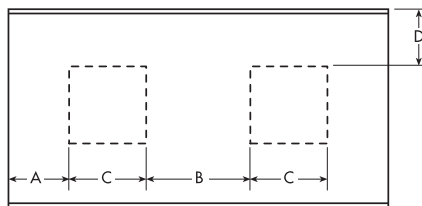

HBF Fairmont Conference Tables

Style Number	List Price			Dimensions			DIA	Weight
	Veneer 1	Veneer 2	Veneer 3	OW	OD	OH		

Wood Bases

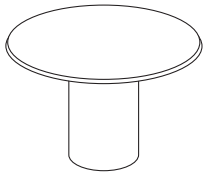

FA74A-Y	3490	3769	4188			29	42	120
FA74B-Y	3725	4023	4470			29	48	133
FA74C-Y	4010	4331	4812			29	54	149
FA74D-Y	4330	4676	5196			29	60	165

Veneer species must be noted on each line item

Wood column base.

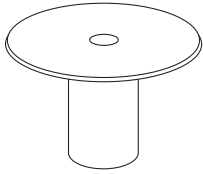

FA74A-YRH1	4225	4563	5070			29	42	130
FA74B-YRH1	4460	4817	5352			29	48	143
FA74C-YRH1	4745	5125	5694			29	54	159
FA74D-YRH1	5065	5470	6078			29	60	175

Veneer species must be noted on each line item

Wood column base, round electrical access grommet.

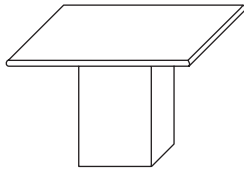

FA77A-I	3185	3440	3882	42	42	29		132
FA77B-I	3425	3699	4110	48	48	29		148
FA77C-I	3700	3996	4440	54	54	29		168
FA77D-I	4010	4331	4812	60	60	29		182

Veneer species must be noted on each line item

Wood column base.

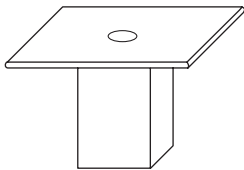

FA77A-IRH1	3920	4234	4704	42	42	29		142
FA77B-IRH1	4160	4493	4992	48	48	29		158
FA77C-IRH1	4435	4790	5322	54	54	29		178
FA77D-IRH1	4745	5125	5694	60	60	29		192

Veneer species must be noted on each line item

Wood column base, round electrical access grommet.

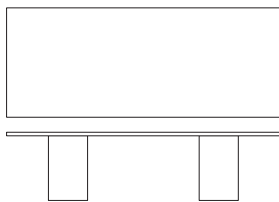

FA78E-I	5725	6183	6870	96	48	29		320
FA78F-I	6720	7258	8064	108	48	29		335
FA78G-I	7350	7938	8820	120	48	29		353

Veneer species must be noted on each line item

Wood column base.

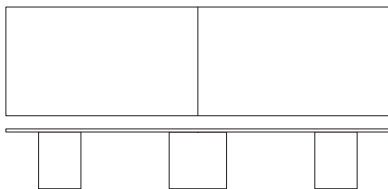

FA78H-I	9270	10012	11124	144	54	29		581
FA78J-I	10220	11038	12264	168	54	29		622
FA78K-I	11810	12755	14172	192	54	29		662
FA78L-I	12440	13435	14928	216	60	29		743

Veneer species must be noted on each line item

Two-piece top, wood column base.

Veneer species must be noted on each line item

Veneer Grade 1	Veneer Grade 2	Veneer Grade 3
Cherry	Rift Oak	Anigre
Maple	Sapele	
Ligno-Grain		
Walnut		

HBF Fairmont Conference Tables

Style Number	List Price			Dimensions			DIA	Weight
	Veneer 1	Veneer 2	Veneer 3	OW	OD	OH		

Wood Bases

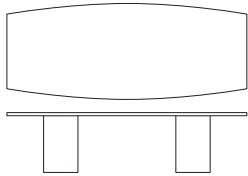

FA80E-Y	6875	7425	8250	96	48	29		298
FA80F-Y	7910	8543	9492	108	48	29		321
FA80G-Y	8575	9261	10290	120	48	29		339

Veneer species must be noted on each line item

Boat top, wood column bases.

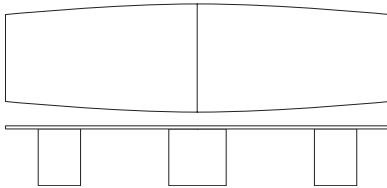

FA80H-Y	10110	10919	12132	144	54	29		545
FA80J-Y	11070	11956	13284	168	54	29		586
FA80K-Y	12650	13662	15180	192	60	29		626
FA80L-Y	13280	14342	15936	216	60	29		707

Veneer species must be noted on each line item

Boat two-piece top, wood column bases.

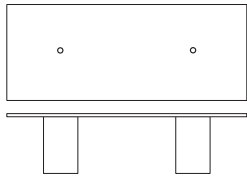

FA78E-IRH2	7195	7771	8634	96	48	29		320
FA78F-IRH2	8190	8845	9828	108	48	29		335
FA78G-IRH2	8820	9526	10584	120	48	29		353

Veneer species must be noted on each line item

Wood column bases, round electrical access grommets.

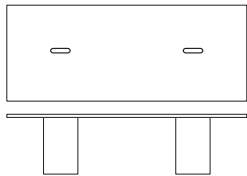

FA78E-IOH2	7615	8224	9138	96	48	29		320
FA78F-IOH2	8610	9299	10332	108	48	29		335
FA78G-IOH2	9240	9979	11088	120	48	29		353

Veneer species must be noted on each line item

Wood column bases, oval electrical access grommets.

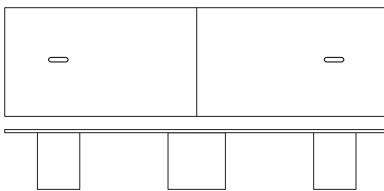

FA78H-IOH2	11160	12053	13392	144	54	29		581
FA78J-IOH2	12110	13079	14532	168	54	29		622
FA78K-IOH2	13700	14796	16440	192	60	29		662
FA78L-IOH2	14330	15476	17196	216	60	29		743

Veneer species must be noted on each line item

Two-piece top, wood column bases, oval electrical access grommets.

Veneer species must be noted on each line item

Veneer Grade 1	Veneer Grade 2	Veneer Grade 3
Cherry	Rift Oak	Anigre
Maple	Sapele	
Ligno-Grain		
Walnut		

HBF Fairmont Conference Tables

Style Number	List Price			Dimensions			DIA	Weight
	Veneer 1	Veneer 2	Veneer 3	OW	OD	OH		

Wood Bases

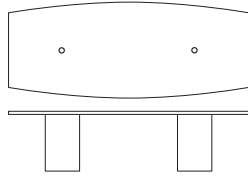

FA80E-YRH2	8345	9013	10014	96	48	29	298
FA80F-YRH2	9380	10130	11256	108	48	29	321
FA80G-YRH2	10045	10849	12054	120	48	29	339

Veneer species must be noted on each line item

Boat top, wood column bases, round electrical access grommets.

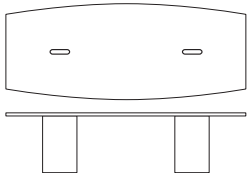

FA80E-YOH2	8765	9466	10518	96	48	29	298
FA80F-YOH2	9800	10584	11760	108	48	29	321
FA80G-YOH2	10465	11302	12558	120	48	29	339

Veneer species must be noted on each line item

Boat top, wood column bases, oval electrical access grommets.

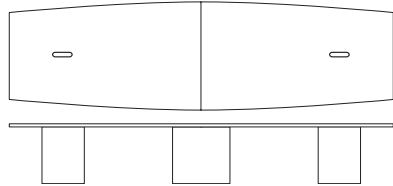

FA80H-YOH2	12000	12960	14400	144	54	29	545
FA80J-YOH2	12960	13997	15552	168	54	29	586
FA80K-YOH2	14540	15703	17448	192	60	29	626
FA80L-YOH2	15170	16384	18204	216	60	29	707

Veneer species must be noted on each line item

Boat two-piece top, wood column bases, oval electrical access grommets.

Veneer species must be noted on each line item

<u>Veneer Grade 1</u>	<u>Veneer Grade 2</u>	<u>Veneer Grade 3</u>
Cherry	Rift Oak	Anigre
Maple	Sapele	
Ligno-Grain		
Walnut		

HBF Fairmont Conference Table Specifications

Tables with Metal Bases

Veneer Premium grade flat cut veneer tops. Edges are bordered with solids.

Top Edge Detail

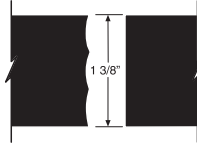

Worksurfaces Fairmont conference tables have a 1 3/8" (35mm) thick top.

Base Options



**Metal X-Base
for Round Tables**

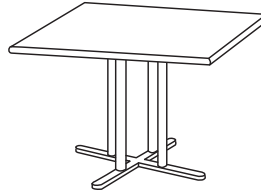

**Metal X-Base
for Square Tables**

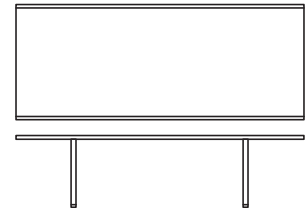

**Metal I-Bases
for Rectangular Tables**

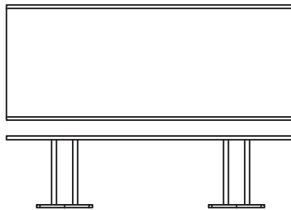

**Metal X-Bases
for Rectangular Tables**

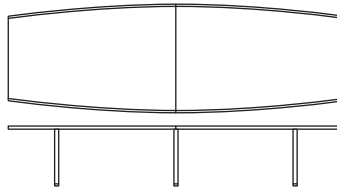

**Metal I-Bases
for Boat Shape Tables**

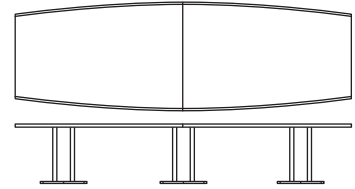

**Metal X-Bases
for Boat Shape Tables**

Metal Bases

Metal bases are available in an I-Base or an X-Base. These bases are standard in HBF Satin Pewter powder coat finish. Refer to individual styles to determine base shape available on particular conference tables. Metal bases for tables specifying power/data capabilities incorporate wire management channels.

HBF Fairmont Conference Table Specifications

Tables with Metal Bases

Round Metal Grommet Power Data Plate

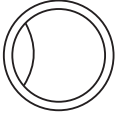

Fairmont Conference Tables with metal bases are available with either a round or oval grommet and power/data access units. Bases for tables with power/data access incorporate wire management channels.

The removable round grommet is standard in HBF Satin Pewter powder coat finish and mounts flush with the top surface. The power/data unit provides two (2) 110 volt electrical outlets and two (2) Cat.5E data jacks. This unit uses a six foot soft cord with a grounded plug.



The hinged oval grommet is standard in HBF Satin Pewter powder coat finish and mounts flush with the top surface. The power/data unit provides four (4) 110 volt electrical outlets and six (6) Cat.5E data jacks. This unit uses a six foot soft cord with a grounded plug.

Oval Metal Grommet Power Data Plate

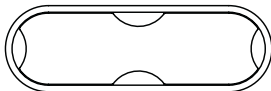

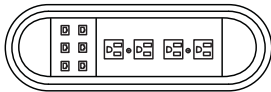

The electrical components provided within this group of furniture are engineered and manufactured in compliance with NEC regulation, however ***it is the responsibility of the specifier and contracted installer of the furniture to be aware of the local building and electrical restrictions.*** Electrical components meet both Chicago and New York electrical codes.

Additional voice/data inserts are available to replace the standard data jacks. These inserts can be ordered from Doug Mockett & Company (www.mockett.com) and installed as required by the end user's data specialist to accommodate specific requirements.

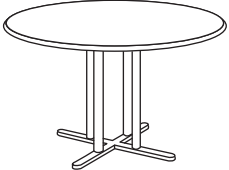
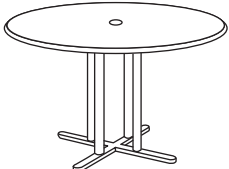
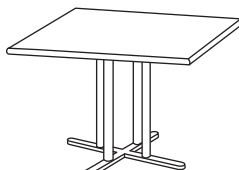
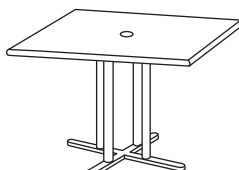

HBF Fairmont Conference Tables

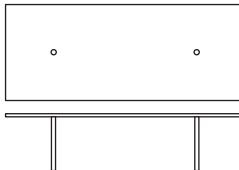
	Style Number	List Price			Dimensions			Weight	
		Veneer 1	Veneer 2	Veneer 3	OW	OD	OH		DIA
Metal Bases									
	FA74A-E	2740	2959	3288			29	42	125
	FA74B-E	3020	3262	3624			29	48	140
	FA74C-E	3495	3775	4194			29	54	155
	FA74D-E	3965	4282	4758			29	60	170
	Veneer species must be noted on each line item								
Metal X-Base.									
	FA74A-ERS1	3475	3753	4170			29	42	125
	FA74B-ERS1	3755	4055	4506			29	48	140
	FA74C-ERS1	4230	4568	5076			29	54	155
	FA74D-ERS1	4700	5076	5640			29	60	170
	Veneer species must be noted on each line item								
Metal X-Base, round electrical access grommet.									
	FA77A-E	2645	2857	3174	42	42	29		140
	FA77B-E	2925	3159	3510	48	48	29		155
	FA77C-E	3305	3569	3966	54	54	29		175
	Veneer species must be noted on each line item								
Metal X-Base.									
	FA77A-ERS1	3305	3569	3966	42	42	29		145
	FA77B-ERS1	3590	3877	4308	48	48	29		160
	FA77C-ERS1	3965	4282	4758	54	54	29		180
	Veneer species must be noted on each line item								
Metal X-Base, round electrical access grommet.									
	FA78C-S	3485	3764	4182	72	36	29		190
	FA78D-S	4005	4325	4806	84	42	29		220
	FA78E-S	4570	4936	5484	96	48	29		260
	FA78F-S	5420	5854	6504	108	48	29		280
	FA78G-S	6460	6977	7752	120	48	29		300
	Veneer species must be noted on each line item								
Metal I-Bases.									
	FA78C-SRS2	4955	5351	5946	72	36	29		190
	FA78D-SRS2	5475	5913	6570	84	42	29		220
	FA78E-SRS2	6040	6523	7248	96	48	29		260
	FA78F-SRS2	6890	7441	8268	108	48	29		280
	FA78G-SRS2	7930	8564	9516	120	48	29		300
	Veneer species must be noted on each line item								
Metal I-Bases, two round electrical access grommets.									
Veneer species must be noted on each line item									
Veneer Grade 1			Veneer Grade 2			Veneer Grade 3			
Cherry			Rift Oak			Anigre			
Maple			Sapele						
Ligno-Grain									
Walnut									

HBF Fairmont Conference Tables

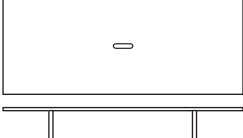
Style Number	List Price			Dimensions			Weight	
	Veneer 1	Veneer 2	Veneer 3	OW	OD	OH		
Metal Bases								
	FA78C-SOS1	4430	4784	5316	72	36	29	195
	FA78D-SOS1	4950	5346	5940	84	42	29	225
	FA78E-SOS1	5515	5956	6618	96	48	29	265
	FA78F-SOS1	6365	6874	7638	108	48	29	285
	FA78G-SOS1	7405	7997	8886	120	48	29	305

Veneer species must be noted on each line item

Metal I-Bases, oval electrical access grommet.

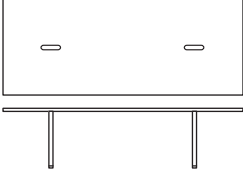
	FA78G-SOS2	8350	9018	10020	120	48	29	310
---	------------	------	------	-------	-----	----	----	-----

Veneer species must be noted on each line item

Metal I-Bases, two oval electrical access grommets.

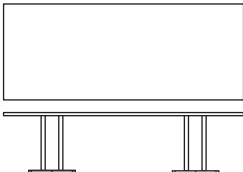
	FA78C-E	4325	4671	5190	72	36	29	230
	FA78D-E	4845	5233	5814	84	42	29	260
	FA78E-E	5410	5843	6492	96	48	29	295
	FA78F-E	6260	6761	7512	108	48	29	320
	FA78G-E	7300	7884	8760	120	48	29	335

Veneer species must be noted on each line item

Metal X-Bases.

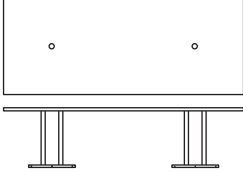
	FA78C-ERS2	5795	6259	6954	72	36	29	230
	FA78D-ERS2	6315	6820	7578	84	42	29	260
	FA78E-ERS2	6880	7430	8256	96	48	29	295
	FA78F-ERS2	7730	8348	9276	108	48	29	320
	FA78G-ERS2	8770	9472	10524	120	48	29	335

Veneer species must be noted on each line item

Metal X-Bases, two round electrical access grommets.

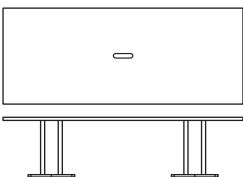
	FA78C-EOS1	5270	5692	6324	72	36	29	195
	FA78D-EOS1	5790	6253	6948	84	42	29	225
	FA78E-EOS1	6355	6863	7626	96	48	29	265
	FA78F-EOS1	7205	7781	8646	108	48	29	285
	FA78G-EOS1	8245	8905	9894	120	48	29	305

Veneer species must be noted on each line item

Metal X-Bases, oval electrical access grommet.

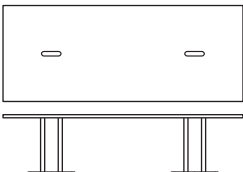
	FA78G-EOS2	9190	9925	11028	120	48	29	310
---	------------	------	------	-------	-----	----	----	-----

Veneer species must be noted on each line item

Metal X-Bases, two oval electrical access grommets.

Veneer species must be noted on each line item

Veneer Grade 1	Veneer Grade 2	Veneer Grade 3
Cherry	Rift Oak	Anigre
Maple	Sapele	
Ligno-Grain		
Walnut		

HBF Fairmont Conference Tables

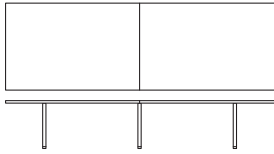
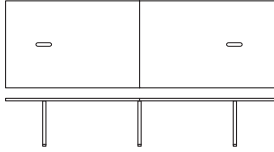
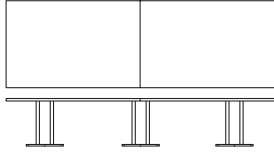
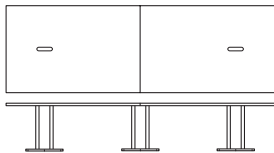
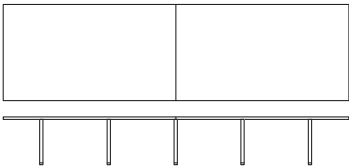
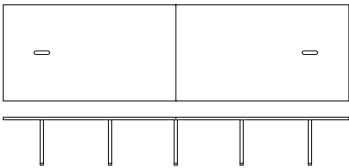
Style Number	List Price			Dimensions			DIA	Weight															
	Veneer 1	Veneer 2	Veneer 3	OW	OD	OH																	
Metal Bases																							
	FA78H-S	8825	9531	10590	144	54	29	420															
	FA78J-S	9675	10449	11610	168	54	29	460															
<p>Veneer species must be noted on each line item</p> <p>Two-piece top, metal I-Bases.</p>																							
	FA78H-SOS2	10715	11572	12858	144	54	29	430															
	FA78J-SOS2	11565	12490	13878	168	54	29	470															
<p>Veneer species must be noted on each line item</p> <p>Two-piece top, metal I-Bases, two oval electrical access grommets.</p>																							
	FA78H-E	10085	10892	12102	144	54	29	475															
	FA78J-E	10935	11810	13122	168	54	29	520															
<p>Veneer species must be noted on each line item</p> <p>Two-piece top, metal X-Bases.</p>																							
	FA78H-EOS2	11975	12933	14370	144	54	29	485															
	FA78J-EOS2	12825	13851	15390	168	54	29	530															
<p>Veneer species must be noted on each line item</p> <p>Two-piece top, metal X-Bases, two oval electrical access grommets.</p>																							
	FA78K-S	10620	11470	12744	192	54	29	585															
	FA78L-S	12235	13214	14682	216	60	29	670															
<p>Veneer species must be noted on each line item</p> <p>Two-piece top, metal I-Bases.</p>																							
	FA78K-SOS2	12510	13511	15012	192	54	29	595															
	FA78L-SOS2	14125	15255	16950	216	60	29	680															
<p>Veneer species must be noted on each line item</p> <p>Two-piece top, metal I-Bases, two oval electrical access grommets.</p>																							
<p>Veneer species must be noted on each line item</p> <table border="0"> <tr> <td><u>Veneer Grade 1</u></td> <td><u>Veneer Grade 2</u></td> <td><u>Veneer Grade 3</u></td> </tr> <tr> <td>Cherry</td> <td>Rift Oak</td> <td>Anigre</td> </tr> <tr> <td>Maple</td> <td>Sapele</td> <td></td> </tr> <tr> <td>Ligno-Grain</td> <td></td> <td></td> </tr> <tr> <td>Walnut</td> <td></td> <td></td> </tr> </table>									<u>Veneer Grade 1</u>	<u>Veneer Grade 2</u>	<u>Veneer Grade 3</u>	Cherry	Rift Oak	Anigre	Maple	Sapele		Ligno-Grain			Walnut		
<u>Veneer Grade 1</u>	<u>Veneer Grade 2</u>	<u>Veneer Grade 3</u>																					
Cherry	Rift Oak	Anigre																					
Maple	Sapele																						
Ligno-Grain																							
Walnut																							

HBF Fairmont Conference Tables

Style Number	List Price			Dimensions			DIA	Weight
	Veneer 1	Veneer 2	Veneer 3	OW	OD	OH		

Metal Bases

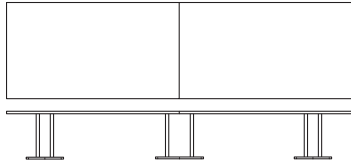

FA78K-E	11040	11923	13248	192	54	29	560
FA78L-E	12655	13667	15186	216	60	29	640

Veneer species must be noted on each line item

Two-piece top, metal X-Bases.

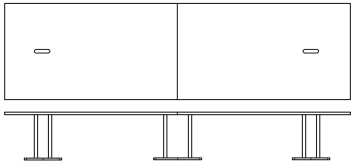

FA78K-EOS2	12930	13964	15516	192	54	29	570
FA78L-EOS2	14545	15709	17454	216	60	29	650

Veneer species must be noted on each line item

Two-piece top, metal X-Bases, two oval electrical access grommets.

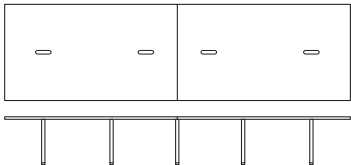

FA78K-SOS4	14400	15552	17280	192	54	29	605
FA78L-SOS4	16015	17296	19218	216	60	29	690

Veneer species must be noted on each line item

Two-piece top, metal I-Bases, four oval electrical access grommets.

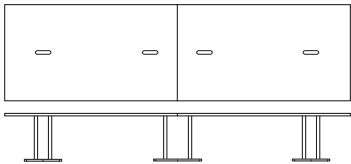

FA78K-EOS4	14820	16006	17784	192	54	29	580
FA78L-EOS4	16435	17750	19722	216	60	29	660

Veneer species must be noted on each line item

Two-piece top, metal X-Bases, four oval electrical access grommets.

Veneer species must be noted on each line item

Veneer Grade 1	Veneer Grade 2	Veneer Grade 3
Cherry	Rift Oak	Anigre
Maple	Sapele	
Ligno-Grain		
Walnut		

HBF Fairmont Conference Tables

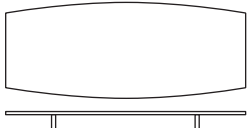
Style Number	List Price			Dimensions			Weight	
	Veneer 1	Veneer 2	Veneer 3	OW	OD	OH		
Metal Bases								
	FA80C-S	4145	4477	4974	72	36	29	190
	FA80D-S	4665	5038	5598	84	42	29	220
	FA80E-S	5235	5654	6282	96	48	29	260
	FA80F-S	6085	6572	7302	108	48	29	280
	FA80G-S	6745	7285	8094	120	48	29	300

Veneer species must be noted on each line item

Boat top, metal I-Bases.

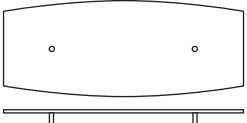
	FA80C-SRS2	5615	6064	6738	72	36	29	200
	FA80D-SRS2	6135	6626	7362	84	42	29	230
	FA80E-SRS2	6705	7241	8046	96	48	29	270
	FA80F-SRS2	7555	8159	9066	108	48	29	290
	FA80G-SRS2	8215	8872	9858	120	48	29	310

Veneer species must be noted on each line item

Boat top, metal I-Bases, two round electrical access grommets.

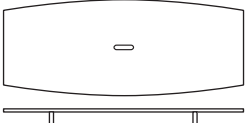
	FA80C-SOS1	5090	5497	6108	72	36	29	200
	FA80D-SOS1	5610	6059	6732	84	42	29	230
	FA80E-SOS1	6180	6674	7416	96	48	29	270
	FA80F-SOS1	7030	7592	8436	108	48	29	290
	FA80G-SOS1	7690	8305	9228	120	48	29	310

Veneer species must be noted on each line item

Boat top, metal I-Bases, one oval electrical access grommet.

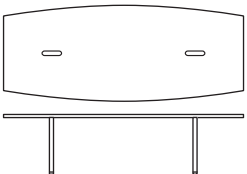
	FA80G-SOS2	8635	9326	10362	120	48	29	310
---	------------	------	------	-------	-----	----	----	-----

Veneer species must be noted on each line item

Boat top, metal I-Bases, two oval electrical access grommets.

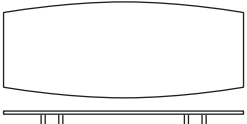
	FA80C-E	4985	5384	5982	72	36	29	230
	FA80D-E	5505	5945	6606	84	42	29	260
	FA80E-E	6075	6561	7290	96	48	29	295
	FA80F-E	6925	7479	8310	108	48	29	320
	FA80G-E	7585	8192	9102	120	48	29	335

Veneer species must be noted on each line item

Boat top, metal X-Bases.

Veneer species must be noted on each line item

Veneer Grade 1	Veneer Grade 2	Veneer Grade 3
Cherry	Rift Oak	Anigre
Maple	Sapele	
Ligno-Grain		
Walnut		

HBF Fairmont Conference Tables

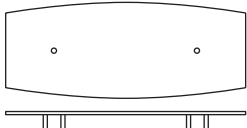
Style Number	List Price			Dimensions			Weight	
	Veneer 1	Veneer 2	Veneer 3	OW	OD	OH		
Metal Bases								
	FA80C-ERS2	6455	6971	7746	72	36	29	190
	FA80D-ERS2	6975	7533	8370	84	42	29	220
	FA80E-ERS2	7545	8149	9054	96	48	29	260
	FA80F-ERS2	8395	9067	10074	108	48	29	280
	FA80G-ERS2	9055	9779	10866	120	48	29	300

Veneer species must be noted on each line item

Boat top, metal X-Bases, two round electrical access grommets.

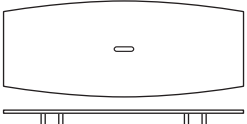
	FA80C-EOS1	5930	6404	7116	72	36	29	235
	FA80D-EOS1	6450	6966	7740	84	42	29	265
	FA80E-EOS1	7020	7582	8424	96	48	29	300
	FA80F-EOS1	7870	8500	9444	108	48	29	325
	FA80G-EOS1	8530	9212	10236	120	48	29	340

Veneer species must be noted on each line item

Boat top, metal X-Bases, one oval electrical access grommet.

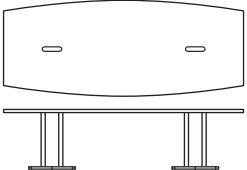
	FA80G-EOS2	9475	10233	11370	120	48	29	345
--	-------------------	-------------	--------------	--------------	-----	----	----	-----

Veneer species must be noted on each line item

Boat top, metal X-Bases, two oval electrical access grommets.

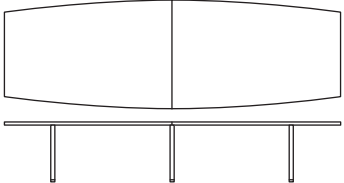
	FA80H-S	9110	9839	10932	144	54	29	420
	FA80J-S	9960	10757	11952	168	54	29	460

Veneer species must be noted on each line item

Boat two-piece top, metal I-Bases.

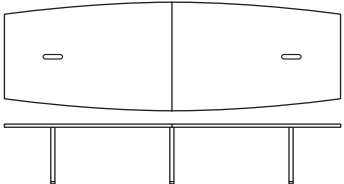
	FA80H-SOS2	11000	11880	13200	144	54	29	430
	FA80J-SOS2	11850	12798	14220	168	54	29	470

Veneer species must be noted on each line item

Boat two-piece top, metal I-Bases, two oval electrical access grommets.

Veneer species must be noted on each line item

<u>Veneer Grade 1</u>	<u>Veneer Grade 2</u>	<u>Veneer Grade 3</u>
Cherry	Rift Oak	Anigre
Maple	Sapele	
Ligno-Grain		
Walnut		

HBF Fairmont Conference Tables

Style Number	List Price			Dimensions			DIA	Weight
	Veneer 1	Veneer 2	Veneer 3	OW	OD	OH		

Metal Bases

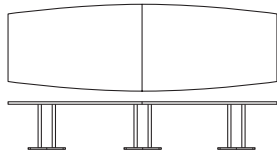

FA80H-E	10370	11200	12444	144	54	29		475
FA80J-E	11220	12118	13464	168	54	29		520

Veneer species must be noted on each line item

Boat two-piece top, metal X-Bases.

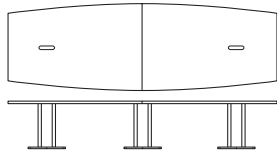

FA80H-EOS2	12260	13241	14712	144	54	29		485
FA80J-EOS2	13110	14159	15732	168	54	29		530

Veneer species must be noted on each line item

Boat two-piece top, metal X-Bases, two oval electrical access grommets.

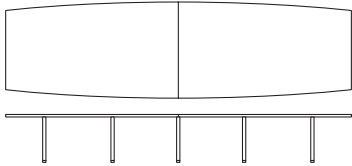

FA80K-S	10905	11777	13086	144	60	29		485
FA80L-S	12520	13522	15024	168	60	29		530

Veneer species must be noted on each line item

Boat two-piece top, metal I-Bases.

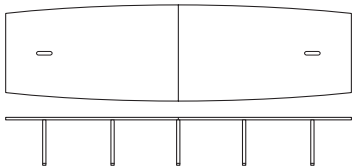

FA80K-SOS2	12795	13819	15354	192	60	29		570
FA80L-SOS2	14410	15563	17292	216	60	29		650

Veneer species must be noted on each line item

Boat two-piece top, metal I-Bases, two oval electrical access grommets.

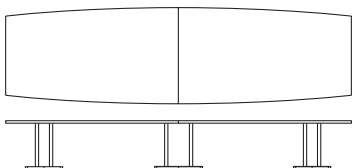

FA80K-E	11325	12231	13590	192	60	29		585
FA80L-E	12940	13975	15528	216	60	29		670

Veneer species must be noted on each line item

Boat two-piece top, metal X-Bases.

Veneer species must be noted on each line item

<u>Veneer Grade 1</u>	<u>Veneer Grade 2</u>	<u>Veneer Grade 3</u>
Cherry	Rift Oak	Anigre
Maple	Sapele	
Ligno-Grain		
Walnut		

HBF Fairmont Conference Tables

Style Number	List Price			Dimensions			DIA	Weight
	Veneer 1	Veneer 2	Veneer 3	OW	OD	OH		

Metal Bases

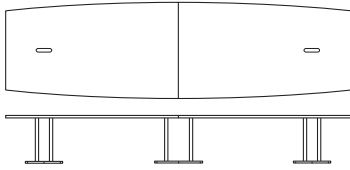

FA80K-EOS2	13215	14272	15858	192	54	29		595
FA80L-EOS2	14830	16016	17796	216	60	29		680

Veneer species must be noted on each line item

Boat two-piece top, metal X-Bases, two oval electrical access grommets.

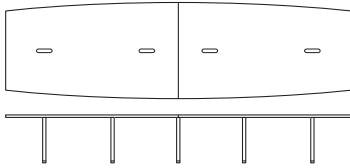

FA80K-SOS4	14685	15860	17622	192	60	29		580
FA80L-SOS4	16300	17604	19560	216	60	29		660

Veneer species must be noted on each line item

Boat two-piece top, metal I-Bases, four oval electrical access grommets.

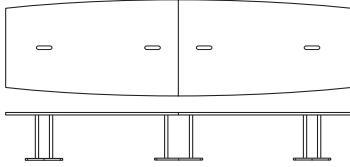

FA80K-EOS4	15105	16313	18126	192	60	29		580
FA80L-EOS4	16720	18058	20064	216	60	29		660

Veneer species must be noted on each line item

Boat two-piece top, metal X-Bases, four oval electrical access grommets.

Veneer species must be noted on each line item

<u>Veneer Grade 1</u>	<u>Veneer Grade 2</u>	<u>Veneer Grade 3</u>
Cherry	Rift Oak	Anigre
Maple	Sapele	
Ligno-Grain		
Walnut		

HBF Fairmont Conference Cabinetry

Style Number	List Price			Dimensions				Weight
	Veneer 1	Veneer 2	Veneer 3	OW	OD	OH	DIA	

Audio Visual Cart

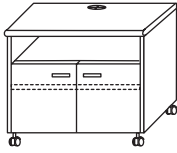

FA53A	2795	3019	3354	36	24	29	192
--------------	-------------	-------------	-------------	----	----	----	-----

Veneer species must be noted on each line item

Cart with open shelf. Lower storage compartment has one adjustable shelf, back is fully finished, casters. Power/communication strip mounted in back of cabinet, includes four electrical outlets and one cable line. Optional black power/data unit can be supplied to mount on any surface of cart. Softwired unit provides two 110 volt electrical outlets and two data jacks. Specify **AC96NB**, add **\$295 List**.

Audio Visual Storage Cabinet, Top without Profile Edge Detail

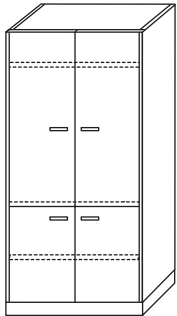

FA53D	6650	7182	7980	38	30	71	271
--------------	-------------	-------------	-------------	----	----	----	-----

Veneer species must be noted on each line item

Standard black unfinished back. Power/communication strip mounted in back of cabinet and includes four electrical outlets and one cable line. Upper storage area accessed through pocket doors. The extendable turntable supports up to 200 lbs., interior dimensions of upper storage area are 31" OW x 29" OD x 40 1/4 OH.

Audio Visual Storage Cabinet, Top with Profile Edge Detail

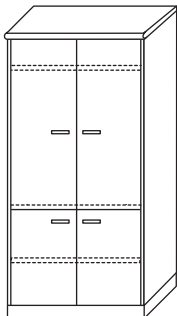

FA53D-C	7050	7614	8460	38	30	72 1/2	286
----------------	-------------	-------------	-------------	----	----	--------	-----

Veneer species must be noted on each line item

Standard black unfinished back. Power/communication strip mounted in back of cabinet and includes four electrical outlets and one cable line. Upper storage area accessed through pocket doors. The extendable turntable supports up to 200 lbs., interior dimensions of upper storage area are 31" OW x 29" OD x 40 1/4 OH.

Wall Mounted Presentation Cabinet, Top without Profile Edge Detail

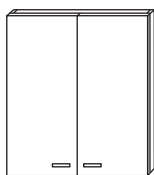

FA37M	2170	2344	2604	48	7	48	210
FA37N	2815	3040	3378	60	7	48	210

Veneer species must be noted on each line item

Presentation cabinet, white marker board (markers and eraser included), pull down projection screen, wood pencil/marker tray. Fabric covered tackboards on inside of each door, fabric requirement is 3 yards per unit. List price includes application of COM, COM must be acrylic backed prior to shipment to HBF. For specification of any HBF Textiles product, add 5% List.

Wall Mounted Presentation Cabinet, Top with Profile Edge Detail

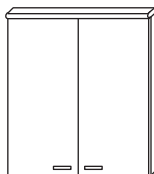

FA37M-C	2470	2668	2964	48	7	49 1/2	210
FA37N-C	3115	3364	3738	60	7	49 1/2	210

Veneer species must be noted on each line item

Presentation cabinet, white marker board (markers and eraser included), pull down projection screen, wood pencil/marker tray. Fabric covered tackboards on inside of each door, fabric requirement is 3 yards per unit. List price includes application of COM, COM must be acrylic backed prior to shipment to HBF. For specification of any HBF Textiles product, add 5% List.

Veneer species must be noted on each line item

<u>Veneer Grade 1</u>	<u>Veneer Grade 2</u>	<u>Veneer Grade 3</u>
Cherry	Rift Oak	Anigre
Maple	Sapele	
Ligno-Grain		
Walnut		

HBF Fairmont Conference Cabinetry

Style Number	List Price			Dimensions				Weight
	Veneer 1	Veneer 2	Veneer 3	OW	OD	OH	DIA	

Plasma Screen Enclosure, Top without Profile Edge Detail

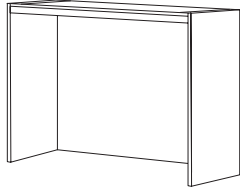

FA54M	1970	2128	2364	48	15	42 1/4	145
FA54A	2625	2835	3150	72	15	42 1/4	165
FA54B	3095	3343	3714	84	15	42 1/4	185

Veneer species must be noted on each line item

Plasma Screen Enclosure, Top with Profile Edge Detail

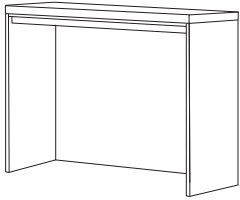

FA54M-C	2270	2452	2724	48	15	43 5/8	150
FA54A-C	2925	3159	3510	72	15	43 5/8	170
FA54B-C	3395	3667	4074	84	15	43 5/8	190

Veneer species must be noted on each line item

Plasma Screen Enclosure, Top without Profile Edge Detail (Double High)

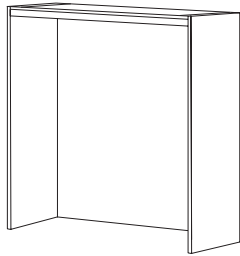

FA54M2	2670	2884	3204	48	15	56	167
FA54A2	3325	3591	3990	72	15	56	187
FA54B2	3795	4099	4554	84	15	56	207

Veneer species must be noted on each line item

Plasma Screen Enclosure, Top with Profile Edge Detail (Double High)

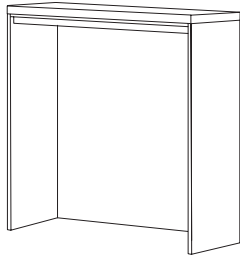

FA54M2-C	2970	3208	3564	48	15	57 3/8	172
FA54A2-C	3625	3915	4350	72	15	57 3/8	192
FA54B2-C	4095	4423	4914	84	15	57 3/8	212

Veneer species must be noted on each line item

Lectern

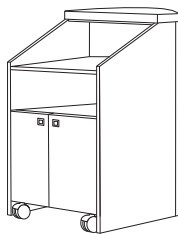

FA53P	4340	4687	5208	31 1/4	27 1/2	48	105
-------	------	------	------	--------	--------	----	-----

Veneer species must be noted on each line item

Veneer species must be noted on each line item

Veneer Grade 1 Veneer Grade 2 Veneer Grade 3

Cherry Rift Oak Anigre
 Maple Sapele
 Ligno-Grain
 Walnut