

Attenzione I disegni di tutte le composizioni si riferiscono alla versione destra. Tutti i prodotti sono disponibili: con 2 braccioli, con 1 bracciolo e senza braccioli. Si prega di ricalcolare il prezzo nel caso sia richiesto un numero di braccioli inferiore o superiore rispetto al disegno standard. Nelle composizioni in pelle, le cuciture non sono simmetriche. I 4 cuscini del set vengono prodotti in un unico tessuto.

Attention Drawings of compositions are always shown as right-facing. All elements available with 2 armrests, 1 armrest or no armrest. Please subtract price of armrest if you wish fewer armrests or add price of additional armrests. Please include plan of desired composition with order. Lowland is not available in fabrics with pattern repeats. Leather compositions have non-symmetrical seams. Cushion set cod. 0MR is available in same fabric only.

Achtung Zeichnungen beziehen sich immer auf rechtseitige Ausführungen. Alle Artikel koennen mit: 2 Armlehnen, 1 Armlehne, ohne Armlehnen geliefert werden. Bitte Preis der einzelnen Armlehne abziehen oder zurechnen falls weniger oder mehr Armlehnen als in den Zeichnungen der Preisliste gewuenscht werden. Fuer Kollektion Lowland koennen Stoffe mit Rapport nicht verwendet werden. Bei Sitzlandschaften in Leder verlaufen die Naehfte nicht symmetrisch. Die 4 kissen aus dem Set werden in einem einzigen stoff produziert.

Attention Les dessins de toutes les compositions se réfèrent à la version droite. Tous les articles peuvent être livrés avec: 2 acc., 1 acc., sans accoudoirs. Il faut déduire le prix de l'accoudoir lorsque vous commandez un nombre d'acc. inférieur à celui sur le croquis ou ajouter le cout de l'accoudoir si vous désirez un accoudoir en plus par rapport au croquis. Ajoutez un petit croquis pour les commandes des compositions. Dans les compositions en cuir, les coutures ne sont pas symétriques. Les 4 coussins du set sont produit dans le même tissu.

Legenda - Description

- 1 Struttura in legno
Hardwood frame
Holzstruktur
Structure en bois
- 2 Piede in acciaio inox
Feet stainless steel
Füße in Edelstahl
Pieds en acier inoxydable
- 3 4-5-6-7-8: Poliuretani a densità e portanza differenziate
4-5-6-7-8: Polyurethane foam in varied densities
4-5-6-7-8: Polyurethanschaum in untersch. Raumdichtigkeiten
4-5-6-7-8: Mousse polyuréth. à densités différenciées
- 9 Ovatta poliestere da 100 gr/mq.
Polyester fiberfill 100 gr/mq.
Polyesterwatte 100 gr/mq.
Fibre polyester a 100 gr/mq.
- 10 Ovatta poliestere da 300 gr/mq.
Polyester fiberfill 300 gr/mq.
Polyesterwatte 300 gr/mq.
Fibre polyester a 300 gr/mq.
- 11 Ovatta poliestere da 500 gr/mq.
Polyester fiberfill 500 gr/mq.
Polyesterwatte 500 gr/mq.
Fibre polyester a 500 gr/mq.
- 12 Cinghie elastiche da 60 mm.
Elastic belts 60 mm.
Elastische Gurte 60 mm.
Sangles élastiques 60 mm.
- 13 Tela cotone 100%
100% cotton cover
Überzug aus Baumwollstoff
Revêtement coton 100%

Struttura

Fusto in legno rivestito con poliuretano espanso indeformabile a densità differenziate e fibra poliestere. I piedi sono in acciaio inox.
A richiesta sottopiedi in PVC.

Il piano dei tavoli è in M.D.F. laccato bianco RAL 9003 opaco o nero RAL 9005 opaco e SONO DISPONIBILI FINO AD ESAURIMENTO SCORTE.

E' disponibile a richiesta la CHAISE LONGUE allungata di cm.20 (da cm.154 a cm.174).

Imbottitura cuscini

I cuscini optional (cod. 0KE - 0KF) sono in fibra poliestere. Vengono forniti nelle versioni:
-stoffa
-stoffa/pelle (prezzo cat. T)

Sovrapprezzi

Maggiorazione per traversa centrale optional per letti 300 €.

Caratteristiche

La collezione LOWLAND è completamente sfoderabile smontando i braccioli e lo schienale; non verrà prodotta con tessuti fiorati, rigati o con verso. Tutte le composizioni, il divano longue (cod. CD9), i letti (cod.175 - 176 - 177) e i tavoli vengono consegnati smontati.

Structure

Stress-resistant polyurethane foam in varied densities and polyester fiberfill on hardwood frame. Feet are stainless steel.

PVC glides may be specified without upcharge. Table top in MDF with white RAL 9003 or black RAL 9005 matt finish. AVAILABILITY ONLY UNTIL END OF STOCK.

On request, CHAISE LONGUE is available with a 174 cm / 68 1/2" length (20 cm / 7 3/4" longer than standard version).

Padding

Optional cushions (code 0KE - 0KF) are polyester fiberfill with fabric or fabric/leather covers (price cat.T)

Surcharge

Upcharge for center beam on beds 300 €.

Spec. Characteristics

LOWLAND covers are removable (after removing arm and backrest); covers are not available in fabrics with pattern repeats. All the compositions, the longue sofa (cod. CD9), beds (cod.175 - 176 -177) and tables are delivered unassembled.

Struktur

Aus Holz, mit unverformbarem Polyurethanschaum in unterschiedlichen Raumdichtigkeiten gepolstert und mit Polyesterwatte umhüllt. Füße aus Edelstahl.

Auf Anfrage Unterfüß in PVC.

Tischplatte ist in M.D.F. lackiert farbe weiss RAL 9003 matt oder schwarz RAL 9005 matt. LIEFERBAR NUR BIS ENDE VORRAT.

Auf Anfrage, ist eine 174 CHAISE LONGUE enhaeltlich (20 cm. laenger).

Kissen Füllung

Optional kissen (cod. 0KE - 0KF) in Dacron faser, werden in den ausfuehrungen: stoff und stoff/leder (preis cat.T) geliefert.

Aufpreis

Aufpreis fuer Mittelstrebe fue Betten 300 €.

Besonderheiten

Kollektion LOWLAND ist komplett abziehbar nach Abnehmen der Arm -und Rückenlehnen und kann nicht mit gemusterten-oder gestreiften Stoffen hergestellt werden. Alle Sitzlandschaften sowie Sofa Longue (cod. CD9), die Betten (Kod.175 - 176 -177) und Tische werden zerlegt ausgeliefert.

Structure

En bois recouverte de mousse polyuréthane indéformable à densités différenciées et ouatte syntétique. Pieds en acier inoxydable. Sur demande sous-pieds er PVC.

Le plateau est en M.D.F. laqué brillant couleur blanc RAL 9003 mat ou noir RAL 9005 mat. DISPONIBLE JUSQU'A' FIN DE STOCK.

Sur demande, la CHAISE LONGUE est disponible avec 20 cm. en plus (c-à-d, 174 cm. au lieu de 154).

Rembourrage





Le coussins optional (cod. 0KE - 0KF) sont en fibre polyester, sont disponible dans le versions: -tissu -tissu/cuir (prix cat.T)

Suppl. de prix

Surcharge de 300 € traverse central pour lits.

Caractéristiques

La collection LOWLAND est complètement déhoussable démontant les accoudoirs e le dossier et n'est pas disponible en tissus avec dessins et rayures. Toutes les compositions, le canapé longue (cod. CD9), les lits (cod.175 - 176 - 177) et les tables sont livrés démontés.

 **Fodera** Cover  **Tessuto** Fabric  **Pelle** Leather  **P. lordo** Gr. Weight  **Volume** Volume
 Ersatzbez Housse Stoff Tissu Leder Cuir Bruttogew. Poids Brut Volumen Volumen

Cod. C18

Divano 2 posti major

2 seater sofa major
Sofa 2-Sitzig Major
Canapé 2 places major

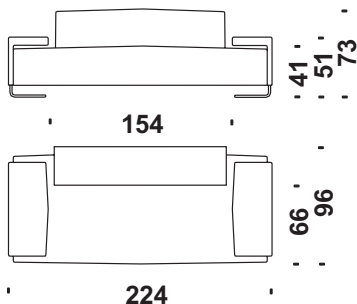

 m 8,6  m² 16,3  Kg 83  m³ 1,7

Cod. C03

Divano 3 posti

3 seater sofa
Sofa 3-Sitzig
Canapé 3 places

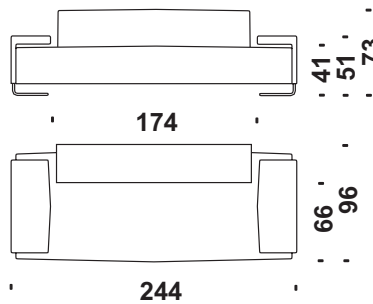

 m 8,8  m² 16,8  Kg 88  m³ 1,9

Cod. CM1

Divano 3 posti major

3 seater sofa major
Sofa 3-Sitzig Major
Canapé 3 places major

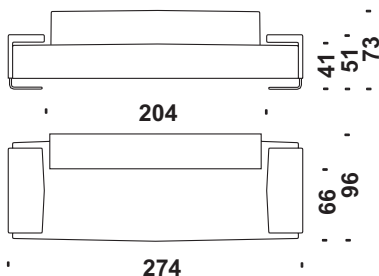

 m 9,2  m² 17,4  Kg 95  m³ 2,1

Cod. CD9

Divano Longue

Longue sofa
Sofa Longue
Canapé Longue

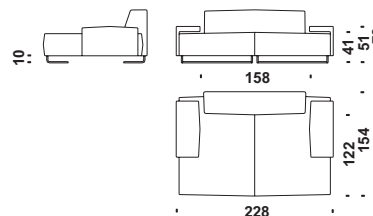

 m 11,8  m² 22,5  Kg 115  m³ 2,3

Cod. 017

Lowland pouf

Lowland stool
Lowland Hocker
Lowland pouf

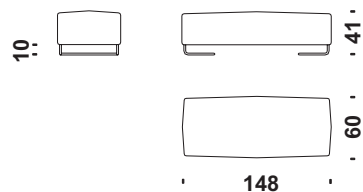

 m 2,4  m² 4,6  Kg 25  m³ 0,25

Cod. 077

Lowland pouf grande

Lowland large stool
Lowland Hocker gross
Lowland pouf grand

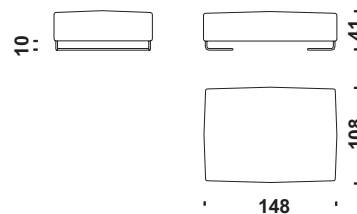

 m 3,9  m² 7,4  Kg 40  m³ 0,8

Fodera Cover **Tessuto** Fabric **Pelle** Leather **P. lordo** Gr. Weight **Volume** Volume
 Ersatzbez Housse Stoff Tissu Leder Cuir Bruttogew. Poids Brut Volumen Volumen

Cod. CA1 **Composizione A1Dx-A1Sx**
 Composition A1R or A1L
 Zusammenstellung A1R oder A1L
 Composition A1D ou A1G

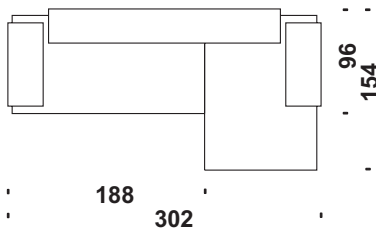

m 12,3 m² 23,6 Kg 129 m³ 2,7

Cod. CA2 **Composizione A2Dx-A2Sx**
 Composition A2R or A2L
 Zusammenstellung A2R oder A2L
 Composition A2D ou A2G

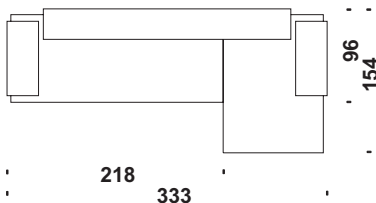

m 13,6 m² 25,9 Kg 136 m³ 3

Cod. CA3 **Composizione A3Dx-A3Sx**
 Composition A3R or A3L
 Zusammenstellung AR oder A3L
 Composition A3D ou A3G

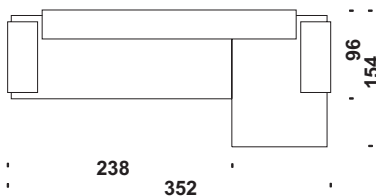

m 13,8 m² 26,2 Kg 141 m³ 3,2

Cod. CB1 **Composizione B1Dx-B1Sx**
 Composition B1R or B1L
 Zusammenstellung B1R oder B1L
 Composition B1D ou B1G

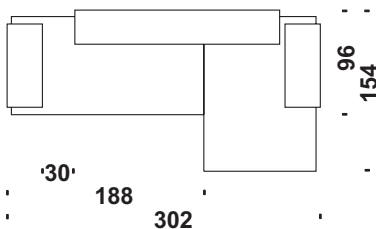

m 12,1 m² 23 Kg 126 m³ 2,5

Cod. CB2 **Composizione B2Dx-B2Sx**
 Composition B2R or B2L
 Zusammenstellung B2R oder B2L
 Composition B2D ou B2G

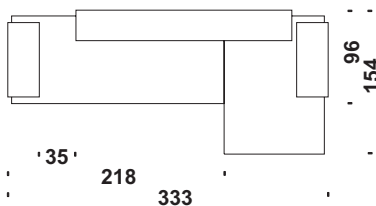

m 13,2 m² 25,2 Kg 134 m³ 2,7

Cod. CB3 **Composizione B3Dx-B3Sx**
 Composition B3R or B3L
 Zusammenstellung B3R oder B3L
 Composition B3D ou B3G

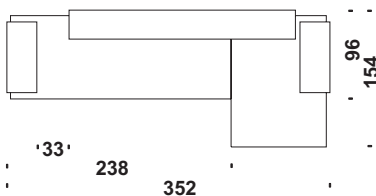

m 13,6 m² 25,9 Kg 138 m³ 3

Fodera Cover **Tessuto** Fabric **Pelle** Leather **P. lordo** Gr. Weight **Volume** Volume
 Ersatzbez Housse Stoff Tissu Leder Bruttogew. Poids Brut Volumen Volume

Cod. CB4 **Composizione B4Dx-B4Sx**
 Composition B4R or B4L
 Zusammenstellung B4R oder B4L
 Composition B4D ou B4G

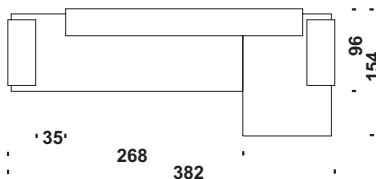

m 13,8 m² 26,2 Kg 144 m³ 3,2

Cod. SC1 **Composizione C1Dx-C1Sx**
 Composition C1R or C1L
 Zusammenstellung C1R oder C1L
 Composition C1D ou C1G

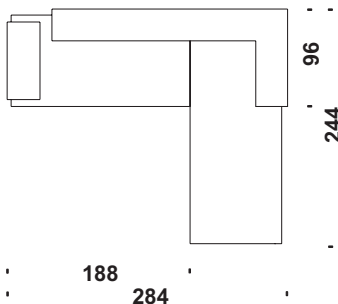

m 13,4 m² 25,6 Kg 157 m³ 3,1

Cod. CC3 **Composizione C3Dx-C3Sx**
 Composition C3R or C3L
 Zusammenstellung C3R oder C3L
 Composition C3D ou C3G

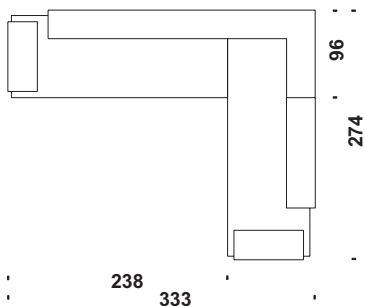

m 17,6 m² 33,5 Kg 192 m³ 5,7

Cod. CC4 **Composizione C4Dx-C4Sx**
 Composition C4R or C4L
 Zusammenstellung C4R oder C4L
 Composition C4D ou C4G

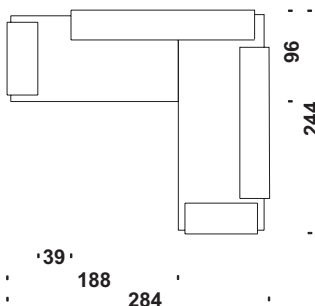

m 15,1 m² 28,7 Kg 162 m³ 3,6

Cod. CC5 **Composizione C5Dx-C5Sx**
 Composition C5R or C5L
 Zusammenstellung C5R oder C5L
 Composition C5D ou C5G

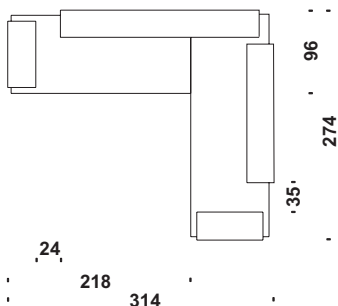

m 16,5 m² 31,4 Kg 177 m³ 4

Cod. CC6 **Composizione C6Dx-C6Sx**
 Composition C6R or C6L
 Zusammenstellung C6R oder C6L
 Composition C6D ou C6G

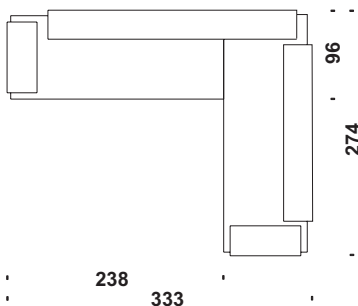

m 17,1 m² 32,5 Kg 184 m³ 4,3

 **Fodera** Cover
 Ersatzbez Housse
 m **Tessuto** Fabric
 Stoff Tissu
 m² **Pelle** Leather
 Leder Cuir
 Kg **P. lordo** Gr. Weight
 Bruttogew. Poids Brut
 m³ **Volume** Volume
 Volumen Volumen

Cod. CD1 **Composizione D1Dx-D1Sx**
 Composition D1R or D1L
 Zusammenstellung D1R oder D1L
 Composition D1D ou D1G

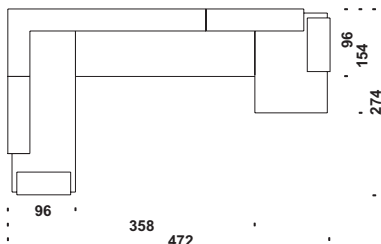

 m 23,6
 m² 44,8
 Kg 253
 m³ 7,5

Cod. CD2 **Composizione D2Dx-D2Sx**
 Composition D2R or D2L
 Zusammenstellung D2R oder D2L
 Composition D2D ou D2G

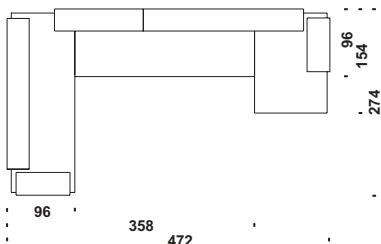

 m 22,7
 m² 43,3
 Kg 245
 m³ 5,7

Cod. CE1 **Composizione E1Dx-E1Sx**
 Composition E1R or E1L
 Zusammenstellung E1R oder E1L
 Composition E1D ou E1G

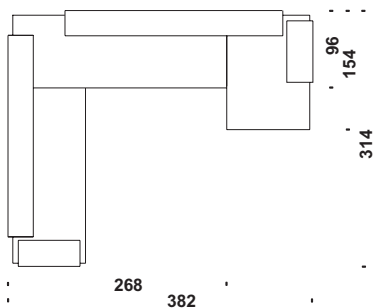

 m 21,5
 m² 40,9
 Kg 225
 m³ 5,1

Cod. CE2 **Composizione E2Dx-E2Sx**
 Composition E2R or E2L
 Zusammenstellung E2R oder E2L
 Composition E2D ou E2G



 m 22,5
 m² 43
 Kg 230
 m³ 6,6

Cod. CE4 **Composizione E4**
 Composition E4
 Zusammenstellung E4
 Composition E4

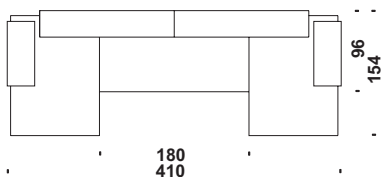

 m 18,1
 m² 34,4
 Kg 185
 m³ 3,7

Cod. CE5 **Composizione E5**
 Composition E5
 Zusammenstellung E5
 Composition E5

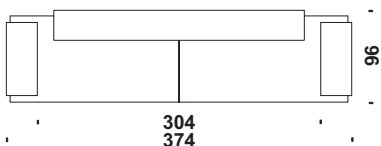

 m 12,8
 m² 24,3
 Kg 140
 m³ 3,3

Fodera Cover m Tessuto Fabric m² Pelle Leather Kg P. lordo Gr. Weight m³ Volume Volume
 Ersatzbez Housse Stoff Tissu Leder Cuir Bruttogew. Poids Brut Volumen Volumen

Cod. SF2 **Composizione F2Dx-F2Sx**
 Composition F2R or F2L
 Zusammenstellung F2R oder F2L
 Composition F2D ou F2G

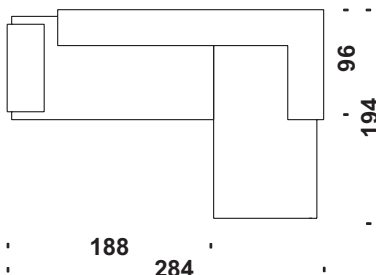

m 12,7 m² 24,2 Kg 150 m³ 3,1

Cod. CF5 **Composizione F5Dx-F5Sx**
 Composition F5R or F5L
 Zusammenstellung F5R oder F5L
 Composition F5D ou F5G

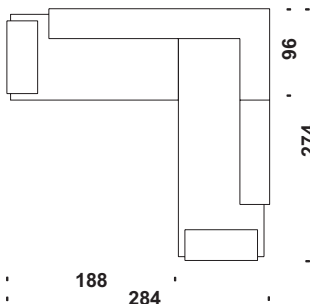

m 16,3 m² 31 Kg 175 m³ 3,8

Cod. CFA **Composizione FADx-FASx**
 Composition FAR or FAL
 Zusammenstellung FAR oder FAL
 Composition FAD ou FAG

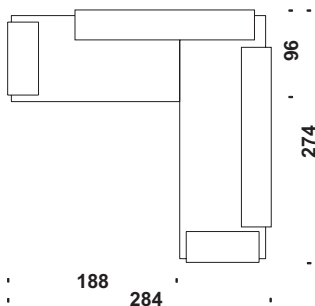

m 15,6 m² 29,6 Kg 169 m³ 4

Cod. CG6 **Composizione G6Dx-G6Sx**
 Composition G6R or G6L
 Zusammenstellung G6R oder G6L
 Composition G6D ou G6G

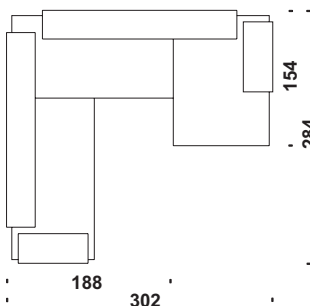

m 19,1 m² 36,2 Kg 206 m³ 4,3

Cod. CG7 **Composizione G7Dx-G7Sx**
 Composition G7R or G7L
 Zusammenstellung G7R oder G7L
 Composition G7D ou G7G

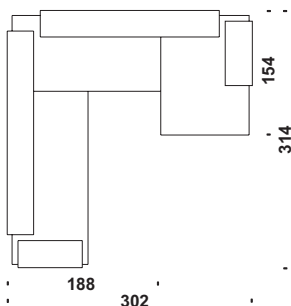

m 20,2 m² 38,4 Kg 208 m³ 4,6

Cod. CG8 **Composizione G8Dx-G8Sx**
 Composition G8R or G8L
 Zusammenstellung G8R oder G8L
 Composition G8D ou G8G

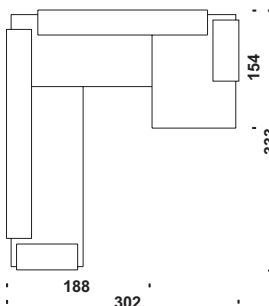

m 20,4 m² 38,8 Kg 213 m³ 4,8

 **Fodera** Cover
 Ersatzbez Housse
 m **Tessuto** Fabric
 Stoff Tissu
 m² **Pelle** Leather
 Leder Cuir
 Kg **P. lordo** Bruttogew.
 Gr. Weight Poids Brut
 m³ **Volume** Volume
 Volumen Volume

Cod. CG9

Composizione G9Dx-G9Sx

Composition G9R or G9L
 Zusammenstellung G9R oder G9L
 Composition G9D ou G9G

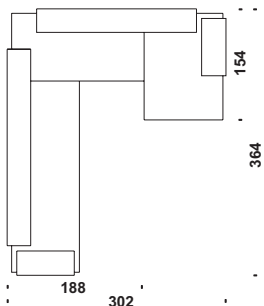

 m 20,4
 m² 38,8
 Kg 218
 m³ 4,8

Cod. CGA

Composizione GADx-GASx

Composition GAR or GAL
 Zusammenstellung GAR oder GAL
 Composition GAD ou GAG

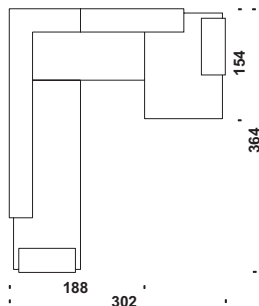

 m 21,2
 m² 40,1
 Kg 220
 m³ 6

Cod. SH2

Composizione H2Dx-H2Sx

Composition H2R or H2L
 Zusammenstellung H2R oder H2L
 Composition H2D ou H2G

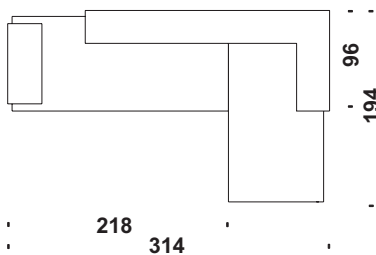

 m 13,5
 m² 25,8
 Kg 155
 m³ 3,1

Cod. SH3

Composizione H3Dx-H3Sx

Composition H3R or H3L
 Zusammenstellung H3R oder H3L
 Composition H3D ou H3G

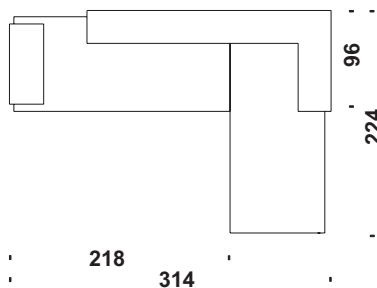

 m 14,3
 m² 27,4
 Kg 160
 m³ 3,3

Cod. CHA

Composizione HADx-HASx

Composition HAR or HAL
 Zusammenstellung HAR oder HAL
 Composition HAD ou HAG

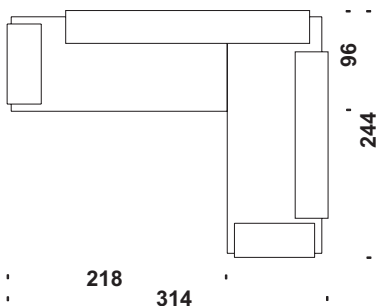

 m 16,5
 m² 31,5
 Kg 172
 m³ 3,8

Cod. CHB

Composizione HBDx-HBSx

Composition HBR or HBL
 Zusammenstellung HBR oder HBL
 Composition HBD ou HBG

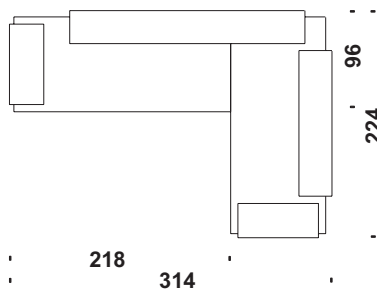

 m 16,3
 m² 31,1
 Kg 170
 m³ 3,8

 **Fodera**
Ersatzbez

Cover
Housse

 m **Tessuto**
Stoff

Fabric
Tissu

 m² **Pelle**
Leder

Leather
Cuir

 Kg **P. lordo**
Bruttogew.

Gr. Weight
Poids Brut

 m³ **Volume**
Volumen

Volume
Volume

Cod. SI2

Composizione I2Dx-I2Sx

Composition I2R or I2L
Zusammenstellung I2R oder I2L
Composition I2D ou I2G

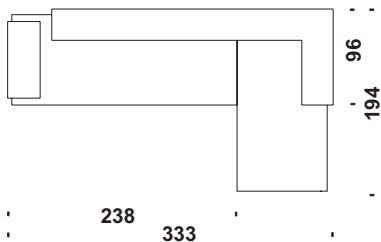

 m 14,1  m² 27  Kg 157  m³ 4,6

Cod. SI4

Composizione I4Dx-I4Sx

Composition I4R or I4L
Zusammenstellung I4R oder I4L
Composition I4D ou I4G

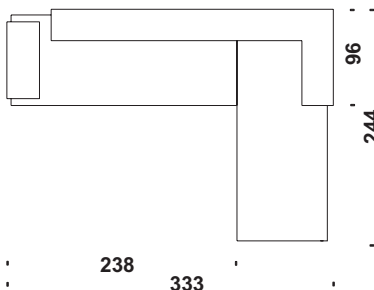

 m 14,9  m² 28,5  Kg 164  m³ 4,9

Cod. CI6

Composizione I6Dx-I6Sx

Composition I6R or I6L
Zusammenstellung I6R oder I6L
Composition I6D ou I6G

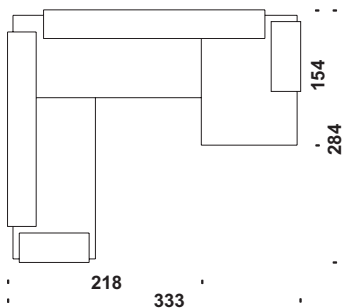

 m 20,2  m² 38,4  Kg 208  m³ 4,6

Cod. CI7

Composizione I7Dx-I7Sx

Composition I7R or I7L
Zusammenstellung I7R oder I7L
Composition I7D ou I7G

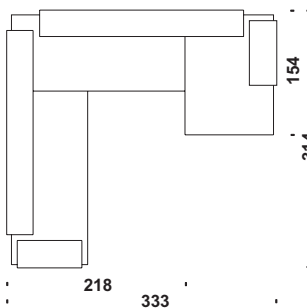

 m 21,3  m² 40,6  Kg 215  m³ 4,9

Cod. CI8

Composizione I8Dx-I8Sx

Composition I8R or I8L
Zusammenstellung I8R oder I8L
Composition I8D ou I8G

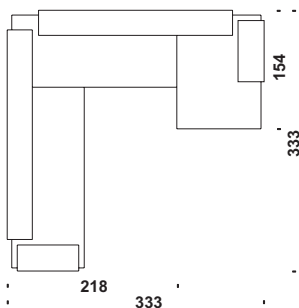

 m 21,5  m² 41  Kg 220  m³ 5,1

Cod. CI9

Composizione I9Dx-I9Sx

Composition I9R or I9L
Zusammenstellung I9R oder I9L
Composition I9D ou I9G

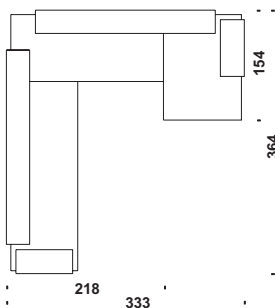

 m 21,5  m² 41  Kg 225  m³ 5,1

Fodera Cover **Tessuto** Fabric **Pelle** Leather **P. lordo** Gr. Weight **Volume** Volume
 Ersatzbez Housse Stoff Tissu Leder Bruttogew. Poids Brut Volumen Volumen

Cod. CIA **Composizione IADx-IASx**
 Composition IAR or IAL
 Zusammenstellung IAR oder IAL
 Composition IAD ou IAG

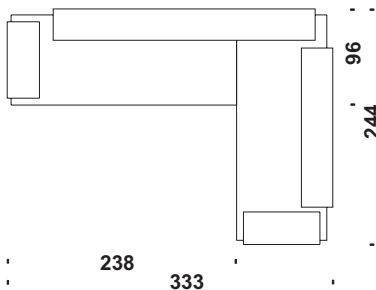

m 16,7 m² 31,9 Kg 177 m³ 4,3

Cod. CIB **Composizione IBDx-IBSx**
 Composition IBR or IBL
 Zusammenstellung IBR oder IBL
 Composition IBD ou IBG

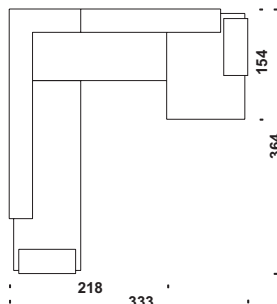

m 22,5 m² 42,8 Kg 230 m³ 6,2

Cod. CIC **Composizione ICDx-ICSx**
 Composition ICR or ICL
 Zusammenstellung ICR oder ICL
 Composition ICD ou ICG

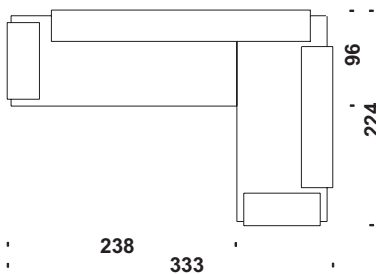

m 16,5 m² 31,5 Kg 175 m³ 4

Cod. CJ6 **Composizione J6Dx-J6Sx**
 Composition J6R or J6L
 Zusammenstellung J6R oder J6L
 Composition J6D ou J6G

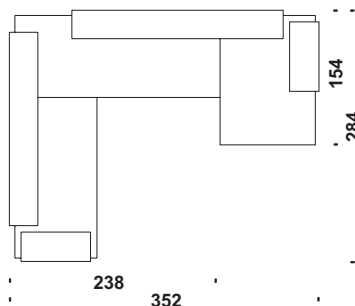

m 20,2 m² 38,4 Kg 210 m³ 4,6

Cod. CJ7 **Composizione J7Dx-J7Sx**
 Composition J7R or J7L
 Zusammenstellung J7R oder J7L
 Composition J7D ou J7G

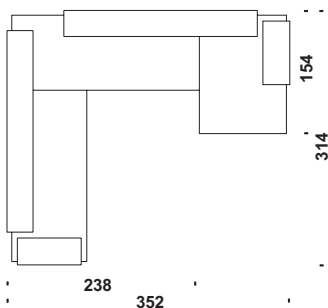

m 21,3 m² 40,6 Kg 217 m³ 4,9

Cod. CJ8 **Composizione J8Dx-J8Sx**
 Composition J8R or J8L
 Zusammenstellung J8R oder J8L
 Composition J8D ou J8G

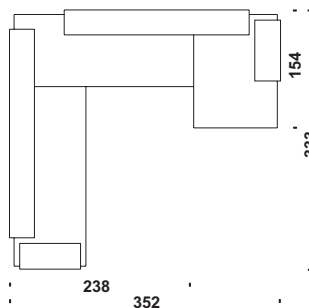

m 21,5 m² 41 Kg 222 m³ 5,1

Fodera Ersatzbez Cover Housse
 m Tessuto Stoff Fabric Tissu
 m² Pelle Leder Leather Cuir
 Kg P. lordo Bruttogew. Gr. Weight Poids Brut
 m³ Volume Volumen Volume Volume

Cod. CJ9

Composizione J9Dx-J9Sx

Composition J9R or J9L
Zusammenstellung J9R oder J9L
Composition J9D ou J9G

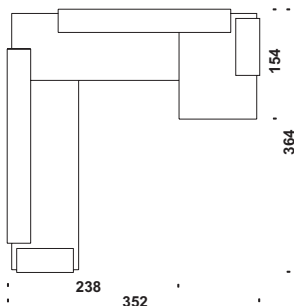

m 21,5 m² 41 Kg 227 m³ 4,1

Cod. CJA

Composizione JADx-JASx

Composition JAR or JAL
Zusammenstellung JAR oder JAL
Composition JAD ou JAG

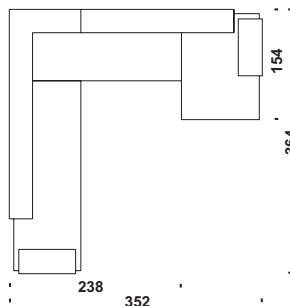

m 22,5 m² 42,8 Kg 232 m³ 6,2

Cod. SK2

Composizione K2Dx-K2Sx

Composition K2R or K2L
Zusammenstellung K2R oder K2L
Composition K2D ou K2G

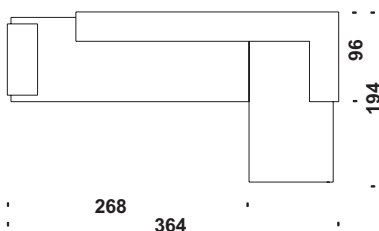

m 14,1 m² 26,9 Kg 162 m³ 4,7

Cod. SK3

Composizione K3Dx-K3Sx

Composition K3R or K3L
Zusammenstellung K3R oder K3L
Composition K3D ou K3G

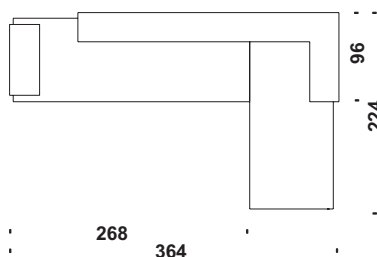

m 14,9 m² 28,5 Kg 167 m³ 4,9

Cod. CK5

Composizione K5Dx-K5Sx

Composition K5R or K5L
Zusammenstellung K5R oder K5L
Composition K5D ou K5G

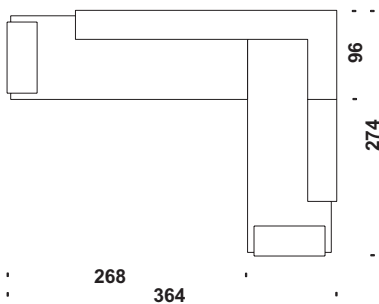

m 17,7 m² 33,7 Kg 192 m³ 5,9

Cod. CKA

Composizione KADx-KASx

Composition KAR or KAL
Zusammenstellung KAR oder KAL
Composition KAD ou KAG

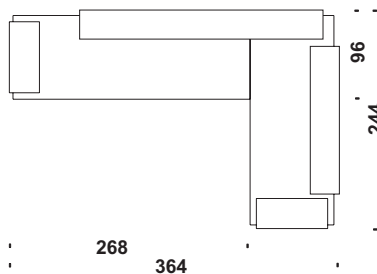

m 16,7 m² 31,9 Kg 182 m³ 4

 **Fodera** Cover
 Ersatzbez Housse
 m **Tessuto** Fabric
 Stoff Tissu
 m² **Pelle** Leather
 Leder Cuir
 Kg **P. lordo** Gr. Weight
 Bruttogew. Poids Brut
 m³ **Volume** Volume
 Volumen Volume

Cod. CKB **Composizione KBDx-KBSx**
 Composition KBR or KBL
 Zusammenstellung KBR oder KBL
 Composition KBD ou KBG

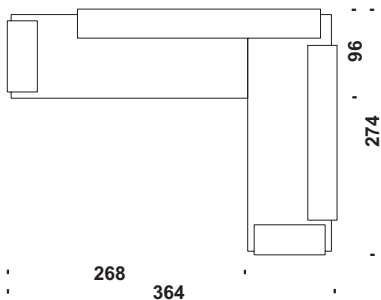

 m 17,1
 m² 32,6
 Kg 189
 m³ 4,3

Cod. CKC **Composizione KCDx-KCSx**
 Composition KCR or KCL
 Zusammenstellung KCR oder KCL
 Composition KCD ou KCG

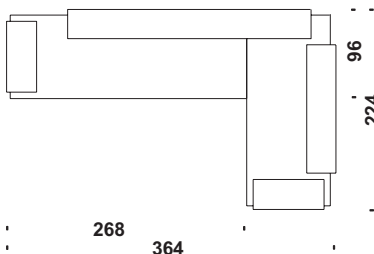

 m 16,5
 m² 31,5
 Kg 180
 m³ 4

Cod. CM6 **Composizione M6Dx-M6Sx**
 Composition M6R or M6L
 Zusammenstellung M6R oder M6L
 Composition M6D ou M6G

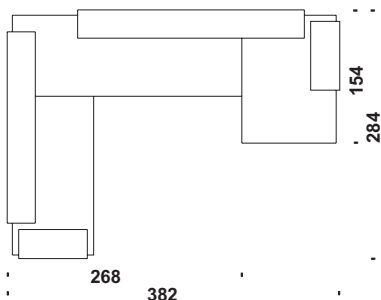

 m 20,4
 m² 38,8
 Kg 218
 m³ 4,8

Cod. CM8 **Composizione M8Dx-M8Sx**
 Composition M8R or M8L
 Zusammenstellung M8R oder M8L
 Composition M8D ou M8G



 m 21,7
 m² 41,4
 Kg 230
 m³ 5,3

Cod. CM9 **Composizione M9Dx-M9Sx**
 Composition M9R or M9L
 Zusammenstellung M9R oder M9L
 Composition M9D ou M9G

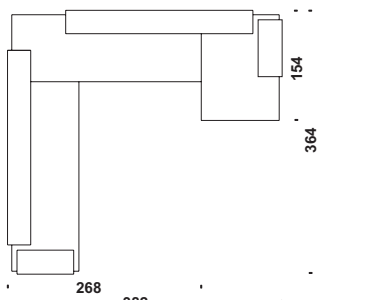

 m 21,7
 m² 41,4
 Kg 235
 m³ 5,3

Cod. CMA **Composizione MADx-MASx**
 Composition MAR or MAL
 Zusammenstellung MAR oder MAL
 Composition MAD ou MAG

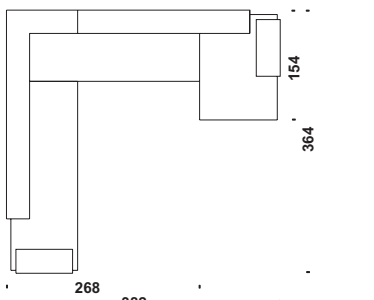

 m 23
 m² 43,8
 Kg 242
 m³ 6,5

 **Fodera** Cover
 Ersatzbez Housse
 m **Tessuto** Fabric
 Stoff Tissu
 m² **Pelle** Leather
 Leder Cuir
 Kg **P. lordo** Gr. Weight
 Bruttogew. Poids Brut
 m³ **Volume** Volume
 Volumen Volume

Cod. SP2 **Composizione P2Dx-P2Sx**
 Composition P2R or P2L
 Zusammenstellung P2R oder P2L
 Composition P2D ou P2G

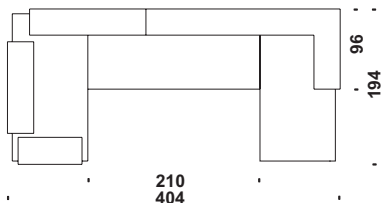

 m 21,1
 m² 40,2
 Kg 232
 m³ 5

Cod. SP3 **Composizione P3Dx-P3Sx**
 Composition P3R or P3L
 Zusammenstellung P3R oder P3L
 Composition P3D ou P3G

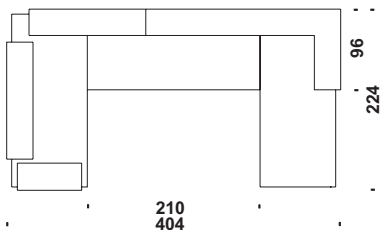

 m 23
 m² 44
 Kg 244
 m³ 5,4

Cod. SP4 **Composizione P4Dx-P4Sx**
 Composition P4R or P4L
 Zusammenstellung P4R oder P4L
 Composition P4D ou P4G

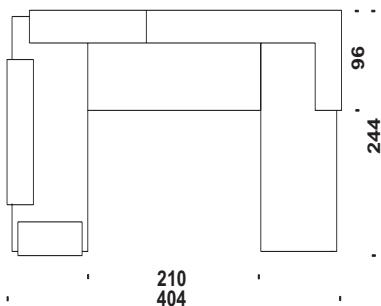

 m 23
 m² 44
 Kg 248
 m³ 5,7

Cod. CP5 **Composizione P5Dx-P5Sx**
 Composition P5R or P5L
 Zusammenstellung P5R oder P5L
 Composition P5D ou P5G

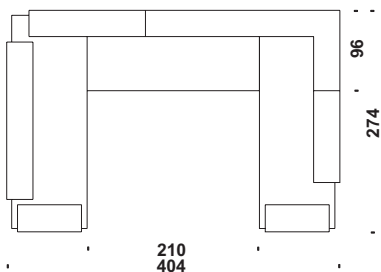

 m 26,4
 m² 50,3
 Kg 276
 m³ 6,1

Cod. SPA **Composizione PADx-PASx**
 Composition PAR or PAL
 Zusammenstellung PAR oder PAL
 Composition PAD ou PAG

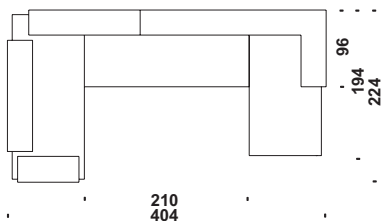



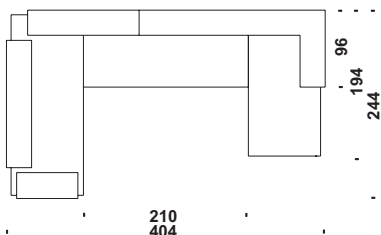

 m 22,2
 m² 42,4
 Kg 239
 m³ 5,2

Cod. SPB **Composizione PBDx-PBSx**
 Composition PBR or PBL
 Zusammenstellung PBR oder PBL
 Composition PBD ou PBG



 m 22,4
 m² 42,8
 Kg 244
 m³ 5,2

 **Fodera** Cover
 Ersatzbez Housse
 m **Tessuto** Fabric
 Stoff Tissu
 m² **Pelle** Leather
 Leder Cuir
 Kg **P. lordo** Gr. Weight
 Bruttogew. Poids Brut
 m³ **Volume** Volume
 Volumen Volumen

Cod. SPC **Composizione PCDx-PCSx**
 Composition PCR or PCL
 Zusammenstellung PCR oder PCL
 Composition PCD ou PCG

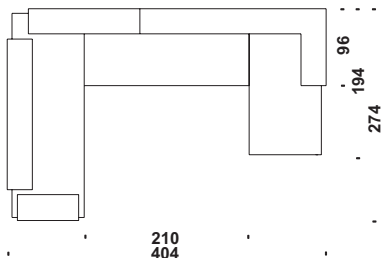

 m 22,8
 m² 43,5
 Kg 253
 m³ 5,4

Cod. DQA **Composizione QADx-QASx**
 Composition QAR or QAL
 Zusammenstellung QAR oder QAL
 Composition QAD ou QAG

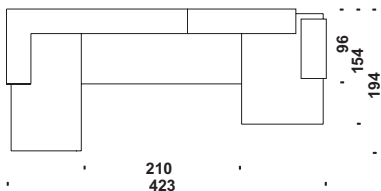

 m 19,5
 m² 37,2
 Kg 208
 m³ 4,4

Cod. DQB **Composizione QBDx-QBSx**
 Composition QBR or QBL
 Zusammenstellung QBR oder QBL
 Composition QBD ou QBG

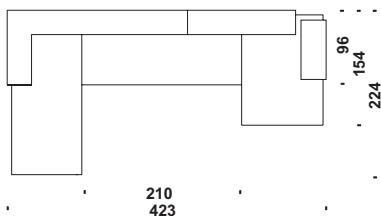

 m 20,3
 m² 38,8
 Kg 213
 m³ 4,6

Cod. DQD **Composizione QDDx-QDSx**
 Composition QDR or QDL
 Zusammenstellung QDR oder QDL
 Composition QDD ou QDG

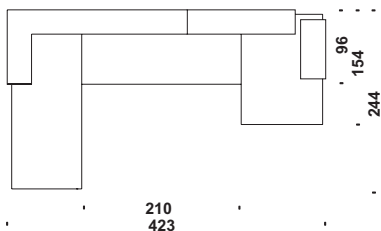

 m 20,3
 m² 38,8
 Kg 215
 m³ 4,6

Cod. CQF **Composizione QFDx-QFSx**
 Composition QFR or QFL
 Zusammenstellung QFR oder QFL
 Composition QFD ou QFG

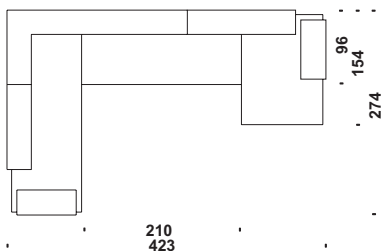

 m 23,1
 m² 44
 Kg 233
 m³ 4,8

Cod. DR2 **Composizione R2Dx-R2Sx**
 Composition R2R or R2L
 Zusammenstellung R2R oder R2L
 Composition R2D ou R2G

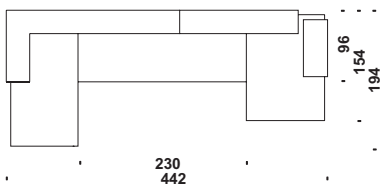

 m 19,7
 m² 37,6
 Kg 213
 m³ 4,4

 **Fodera** Cover
 Ersatzbez Housse
 m **Tessuto** Fabric
 Stoff Tissu
 m² **Pelle** Leather
 Leder Cuir
 Kg **P. lordo** Gr. Weight
 Bruttogew. Poids Brut
 m³ **Volume** Volume
 Volumen Volumen

Cod. DR3

Composizione R3Dx-R3Sx

Composition R3R or R3L
 Zusammenstellung R3R oder R3L
 Composition R3D ou R3G

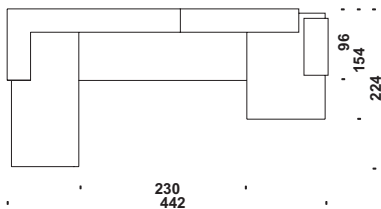

 m 20,5
 m² 39,2
 Kg 218
 m³ 4,6

Cod. CR5

Composizione R5Dx-R5Sx

Composition R5R or R5L
 Zusammenstellung R5R oder R5L
 Composition R5D ou R5G

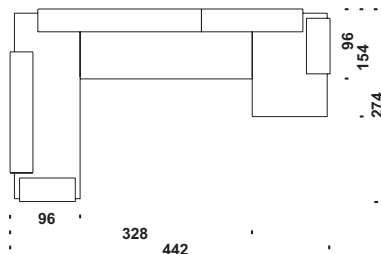

 m 22,2
 m² 42,3
 Kg 230
 m³ 5,1

Cod. SS2

Composizione S2Dx-S2Sx

Composition S2R or S2L
 Zusammenstellung S2R oder S2L
 Composition S2D ou S2G

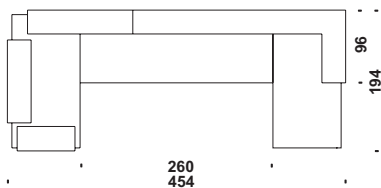

 m 21,7
 m² 41,3
 Kg 244
 m³ 6,9

Cod. SS3

Composizione S3Dx-S3Sx

Composition S3R or S3L
 Zusammenstellung S3R oder S3L
 Composition S3D ou S3G

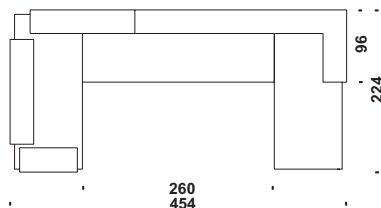

 m 23,6
 m² 45,1
 Kg 256
 m³ 7

Cod. CS5

Composizione S5Dx-S5Sx

Composition S5R or S5L
 Zusammenstellung S5R oder S5L
 Composition S5D ou S5G

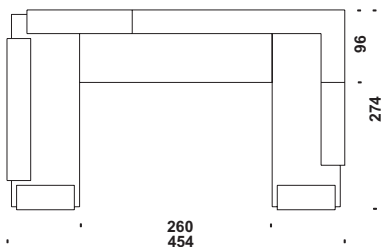

 m 27
 m² 51,4
 Kg 288
 m³ 8

Cod. SSA

Composizione SADx-SASx

Composition SAR or SAL
 Zusammenstellung SAR oder SAL
 Composition SAD ou SAG

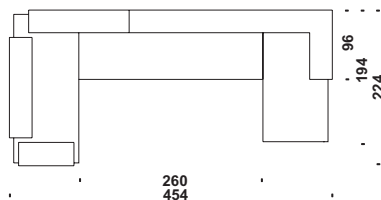

 m 22,8
 m² 43,5
 Kg 251
 m³ 6,8

 **Fodera**
Ersatzbez

Cover
Housse

 m **Tessuto**
Stoff

Fabric
Tissu

 m² **Pelle**
Leder

Leather
Cuir

 Kg **P. lordo**
Bruttogew.

Gr. Weight
Poids Brut

 m³ **Volume**
Volumen

Volume
Volume

Cod. SSB

Composizione SBDx-SBSx

Composition SBR or SBL
Zusammenstellung SBR oder SBL
Composition SBD ou SBG



Cod. SSC

Composizione SCDx-SCSx

Composition SCR or SCL
Zusammenstellung SCR oder SCL
Composition SCD ou SCG

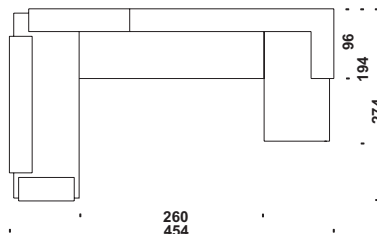

 m 23  m² 43,9  Kg 256  m³ 7,1

 m 23,4  m² 44,6  Kg 263  m³ 7,1

Cod. DT2

Composizione T2Dx-T2Sx

Composition T2R or T2L
Zusammenstellung T2R oder T2L
Composition T2D ou T2G

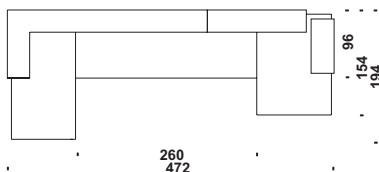

Cod. DT3

Composizione T3Dx-T3Sx

Composition T3R or T3L
Zusammenstellung T3R oder T3L
Composition T3D ou T3G

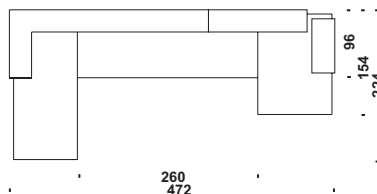

 m 20,1  m² 38,3  Kg 220  m³ 6

 m 20,9  m² 39,9  Kg 225  m³ 6,2

Cod. DT4

Composizione T4Dx-T4Sx

Composition T4R or T4L
Zusammenstellung T4R oder T4L
Composition T4D ou T4G

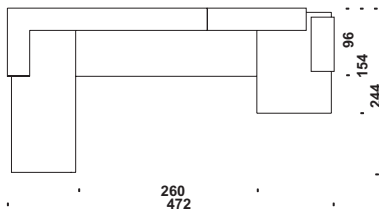

Cod. CTA

Composizione TADx-TASx

Composition TAR or TAL
Zusammenstellung TAR oder TAL
Composition TAD ou TAG

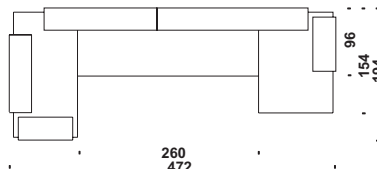

 m 20,9  m² 39,9  Kg 227  m³ 6,2

 m 20,9  m² 39,7  Kg 218  m³ 4,6

Fodera Cover **Tessuto** Fabric **Pelle** Leather **P. lordo** Gr. Weight **Volume** Volume
 Ersatzbez Housse Stoff Tissu Leder Cuir Bruttogew. Poids Brut Volumen Volumen

Cod. CTB

Composizione TBDx-TBSx

Composition TBR or TBL
 Zusammenstellung TBR oder TBL
 Composition TBD ou TBG

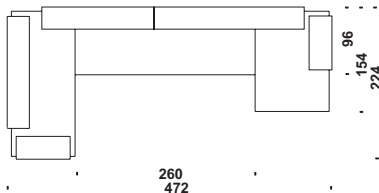

Cod. CTC

Composizione TCDx-TCSx

Composition TCR or TCL
 Zusammenstellung TCR oder TCL
 Composition TCD ou TCG

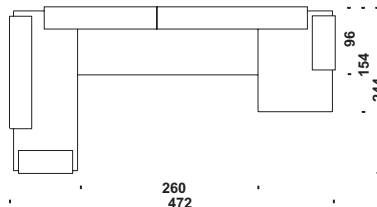

m 22,2 m² 42,3 Kg 228 m³ 4,8

m 22,2 m² 42,3 Kg 230 m³ 4,8

Maggiorazione Ch.Longue cm.174

Surcharge Ch.Longue cm.174
 Aufpreis Ch.Longue cm.174
 Surcharge Ch.Longue cm.174

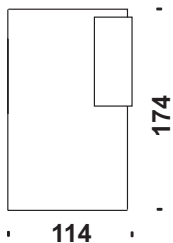

Cod. OKE

Lowland cuscino optional 55x45

Lowland optional cushion 55x45
 Lowland Kissen optional 55x45
 Lowland coussin optional 55x45

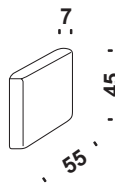

m 1,1 m² 1,2

Cod. OKF

Lowland cuscino optional 50x40

Lowland optional cushion 50x40
 Lowland Kissen optional 50x40
 Lowland coussin optional 50x40

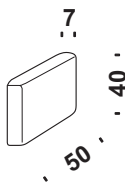

m 1 m² 1,1

Cod. OMR

Set 4 cuscini 2 KE+2 KF

4 cushions set-2 KE+2 KF
 4 Kissen set-2 KE+2 KF
 4 coussins set-2 KE+2 KF

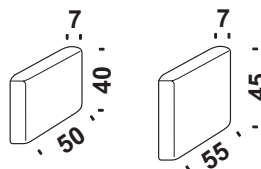

m 2,3

Fodera Cover **Tessuto** Fabric **Pelle** Leather **P. lordo** Gr. Weight **Volume** Volume
 Ersatzbez Housse Stoff Tissu Leder Cuir Bruttogew. Poids Brut Volumen Volumen

Cod. 175 **Letto 160**

Bed 160
Bett 160
Lit 160

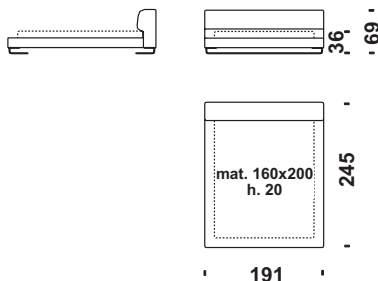

m 6,8 m² 13,5 Kg 85 m³ 1,6

Cod. 176 **Letto 170**

Bed 170
Bett 170
Lit 170

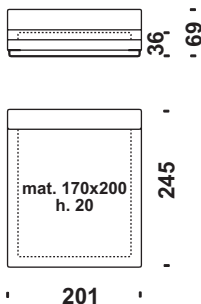

m 7,2 m² 14 Kg 87 m³ 1,6

Cod. 177 **Letto 180**

Bed 180
Bett 180
Lit 180

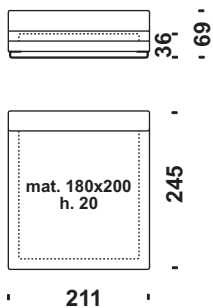

m 7,5 m² 14,5 Kg 89 m³ 1,6

Cod. 195 **Rete doghe 200x160**

Slatted base 200x160
Lattenrost 200x160
Sommier à lattes 200x160

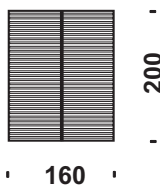

m³ 0,25

Cod. 196 **Rete doghe 200x170**

Slatted base 200x170
Lattenrost 200x170
Sommier à lattes 200x170

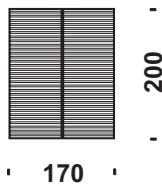

m³ 0,25

Cod. 197 **Rete doghe 200x180**

Slatted base 200x180
Lattenrost 200x180
Sommier à lattes 200x180

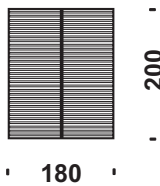

m³ 0,25

 **Fodera**
Ersatzbez

Cover
Housse

 m **Tessuto**
Stoff

Fabric
Tissu

 m² **Pelle**
Leder

Leather
Cuir

 Kg **P. lordo**
Bruttogew.

Gr. Weight
Poids Brut

 m³ **Volume**
Volumen

Volume
Volume

Cod. 02E

Bracciolo 02EDx - 02FSx

Arm 02ER - 02FL
Armlehne 02ER - 02FL
Accoudoir 02ED - 02FG

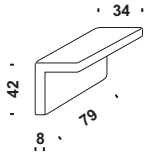

 m 1,6

 m² 2,4

Cod. 0CE

Tavolo 100x45x47

Table 100x45x47
Tisch 100x45x47
Table 100x45x47

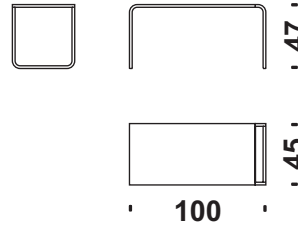

 Kg 15

 m³ 0,3

Cod. 0CF

Tavolo 80x130x31

Table 80x130x31
Tisch 80x130x31
Table 80x130x31

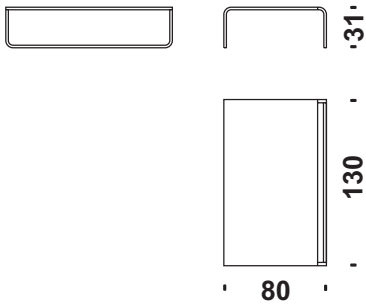

 Kg 20

 m³ 0,45