**Legenda - Description**

- 1 Base girevole in acciaio
Revolving basement in steel
Drehbares untergestell aus Stahl
Base pivotante en acier
- 2 Struttura in acciaio
Steel structure
Stahlstruktur
Structure en acier
- 3 Schiuma poliuretanic
flessibile con densità 60 Kg/m³
Flexible polyurethane foam
60 Kg/m³
Flexibler polyurethanschaum
60 Kg/m³
Mousse en polyuréthane flexible a
60 Kg/m³

Struttura

Espanso schiumato a freddo con struttura in acciaio per le poltrone e sgabelli e in materiale plastico composito per le scocche delle poltroncine e barre.

POUF (cod. 214-017-077):
guscio in plastica antiurto, termoformata di colore nero.
BARRE:
struttura portante in acciaio verniciato canna di fucile.
Piedi in fusione di alluminio lucidato con tavolo in laminato HPL di colore bianco o nero opaco.
TAVOLI 0S1 - 06P:
base quadrata in acciaio verniciato grigio o nero con piano in MDF nobilitato bianco
TAVOLI BISTROT 016 - 0GR:
base quadrata in fusione di ghisa, colonna in acciaio verniciato nero opaco con piano in MDF nobilitato bianco.
TAVOLI 0SA - 0S2:
base in acciaio verniciato bianco o nero opachi con piano in MDF laccato bianco o nero lucidi.

Sovrapprezzi

E' possibile a richiesta montare sulla poltroncina (cod.106) il basamento in inox 316 L con una maggiorazione di € 32.

Caratteristiche

La collezione FJORD non è sfoderabile.

Structure

Steel frame covered with injected cold foam. Codes 105-110 and beam seating, technopolymer composite shell covered with injected cold foam.

FOOT STOOLS (cod. 214-017-077):
shell in shock absorbant plastic colour black.
BEAMS:
frame in varnished tube rifle brown steel.
Feet in polished aluminium casting.
Table in HPL white or black.
TABLES 0S1 - 06P:
square base steel varnished grey or black.
Tabletop in MDF covered in white plastic.
TABLES BISTROT 016 - 0GR:
square base in cast iron, column in steel varnished black. Tabletop in MDF covered in white plastic.
TABLES 0SA - 0S2:
base in steel varnished white or black. Tabletop in MDF highgloss white or black lacquered.

Surcharge

On request, the base of the armchair (code 106) is also available in stainless steel 316 L with a surcharge of € 32.

Spec. Characteristics

The collection FJORD has no removable covers.

Struktur

Stahlgestell kaltgeschäum. Kodes 105-110 und Modular System, Technopolymer in Schichtverfahren Schale kaltgeschäum.

HOCKER (Kode 214-017-077):
Kunststoffschale schwarz stossfest.
MODULAR SYSTEM:
Untergestell in Stahl Kanonengrau lackiert.
Fuesse in Druckguss Aluminium.
Tisch in HPL weiss oder schwarz.
TISCHEN 0S1 - 06P:
Untergestell viereckig aus Stahl lackiert grau oder schwarz. Tischplatte MDF umhüllt in Plastik Weiss.
TISCHEN BISTROT 016 - 0GR:
Untergestell viereckig aus Gusseisen, Säule Stahl lackiert schwarz. Tischplatte MDF umhüllt in Plastik Weiss.
TISCHE 0SA - 0S2:
Untergestell Stahl lackiert Weiss oder Schwarz.
Tischplatte in MDF Weiss oder Schwarz hochglanz lackiert.

Aufpreis

Auf Anfrage, mit einem Aufpreis von € 32 kann das Untergestell des Sessel (Kode 106) in Edelstahl 316 L geliefert werden.

Besonderheiten

Kollektion FJORD ist nicht abziehbar.

Structure

Acier enrobée dans mousse injectée a froid. Technopolymer enrobée dans mousse injectée a froid pour les codes 105-110 et les poutres.

POUFS (code 214-017-077):
coquille en plastic anti-choc couleur noir.
POUTRES:
acier vernis gris fusil.
Les pieds sont en aluminium brillant.
Table en HPL blanc ou noir.
TABLES 0S1 - 06P:
base carré en acier vernis gris ou noir. Plateau en MDF revetu en plastique blanc.
TABLES BISTROT 016 - 0GR:
base carré en fonte, colonne en acier vernis noir. Plateau en MDF revetu en plastique blanc.
TABLES 0SA - 0S2:
base en acier vernis blanc ou noir. Plateau en MDF laqué blanc ou noir brillante.

Suppl. de prix

Sur demande, la base du fauteuil (code 106) est aussi disponible en acier inoxydable 316 L avec un supplement de prix de € 32.

Caractéristiques

La collection FJORD n'est pas déhoussable.

 **Fodera** Cover
 Ersatzbez Housse
 m **Tessuto** Fabric
 Stoff Tissu
 m² **Pelle** Leather
 Leder Cuir
 Kg **P. lordo** Gr. Weight
 Bruttogew. Poids Brut
 m³ **Volume** Volume
 Volumen Volume

Cod. 03K Poltrona Relax opzioni A-C-E

Armchair Relax options A-C-E
 Sessel Relax varianten A-C-E
 Fauteuil Relax option A-C-E

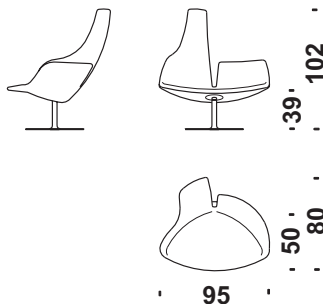

 m 3,2
 m² 3,3
 Kg 34
 m³ 0,9

Cod. 001 Poltrona base inox opzioni A-C

Armch. stainless steel base opt. A-C
 Sessel Gestell Edelstahl var. A-C
 Fauteuil base inox option A-C

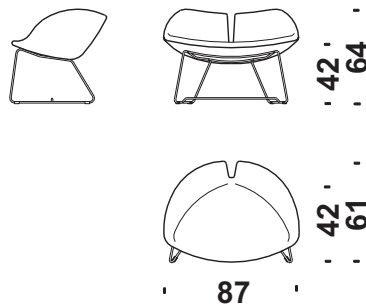

 m 2
 m² 2,8
 Kg 14
 m³ 0,5

Cod. 0V6 Poltrona girevole opzioni A-C-E

Swivel armchair options A-C-E
 Drehsessel varianten A-C-E
 Fauteuil pivotant option A-C-E

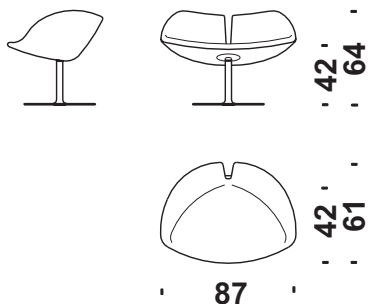



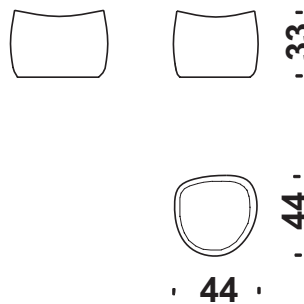

 m 2
 m² 2,8
 Kg 28
 m³ 0,5

Cod. 214 Fjord pouf piccolo opzioni B-D

Fjord small foot stool options B-D
 Fjord Hocker klein varianten B-D
 Fjord pouf petit option B-D





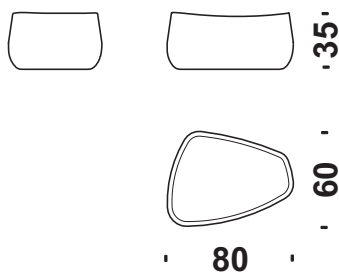

 m 0,9
 m² 0,4 - 1,7
 Kg 10
 m³ 0,15

Cod. 017 Fjord pouf opzioni B-D

Fjord foot stool options B-D
 Fjord Hocker varianten B-D
 Fjord pouf option B-D





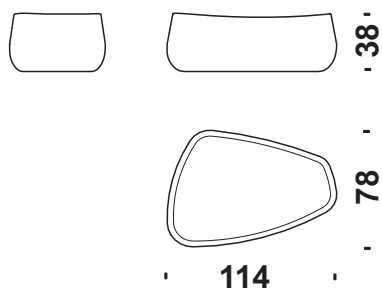

 m 1
 m² 0,6 - 2,1
 Kg 14
 m³ 0,3

Cod. 077 Fjord pouf grande opzioni B-D

Fjord large foot stool options B-D
 Fjord Hocker gross varianten B-D
 Fjord pouf grand option B-D



 m 1,7
 m² 1 - 3,4
 Kg 21
 m³ 0,4

Fodera Cover m Tessuto Fabric m² Pelle Leather Kg P. lordo Gr. Weight m³ Volume Volume
 Ersatzbez Housse Stoff Tissu Leder Cuir Bruttogew. Poids Brut Volumen Volumen

Cod. 050 Sedia base cromata opz.C

Chair chromed base opt.C
 Stuhl Gestell verchromt var.C
 Chaise base chromé opt.C

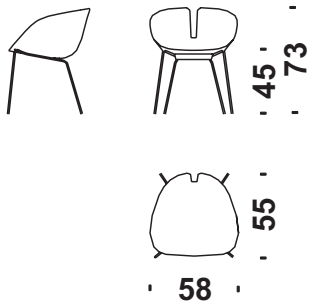

m 1,4 m² 2,2 Kg 10 m³ 0,3

Cod. 105 Poltr.base bianca/grigia opz.C

Armch.white/grey base opt.C
 Sessel Gestell weiss/grau var.C
 Fauteuil base blanc/gris opt.C

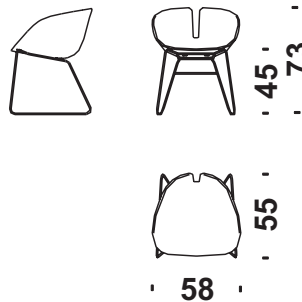

m 1,4 m² 2,2 Kg 10 m³ 0,3

Cod. 106 Poltronc.base inox opz.C

Armch.stainless base opt.C
 Sessel Gest.Edelstahl var.C
 Fauteuil base inox opt.C

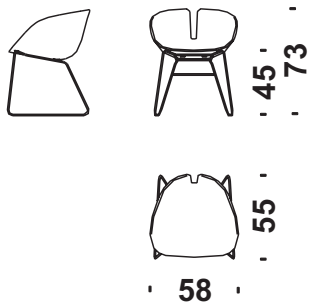

m 1,4 m² 2,2 Kg 10 m³ 0,3

Cod. 108 Poltr.base 5 razze allum.opz.C

Armchair alum.starbase opt.C
 Sessel Sterngest.Alum.var.C
 Fauteuil base alum.5 br.opt.C

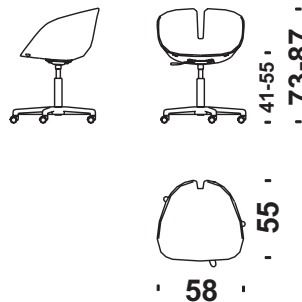

m 1,4 m² 2,2 Kg 13 m³ 0,4

Cod. 111 Sgabello basso base inox opz.C

Bar stool low stainless base opt.C
 Barhocker tief Gest.Edelst.var.C
 Tab.bar bas base inox opt.C

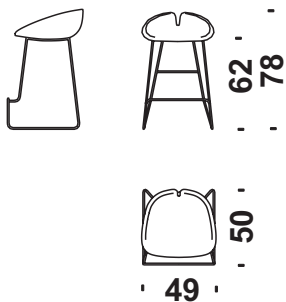



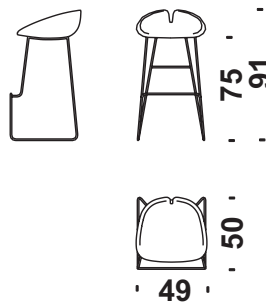

m 1 m² 1,2 Kg 10 m³ 0,25

Cod. 112 Sgabello alto base inox opz.C

Bar stool high stainless base opt.C
 Barhocker hoch Gest.Edelst.var.C
 Tab.bar haut base inox opt.C



m 1 m² 1,2 Kg 10 m³ 0,4

 **Fodera** Cover  **Tessuto** Fabric  **Pelle** Leather  **P. lordo** Gr. Weight  **Volume** Volume

Cod. 07N Sgabello bar girev.vern.all.opz.C

Bar stool swivel varn.al.opt.C
Barhocker drehbar lack.Al.var.C
Tabouret bar piv.vernis al.opt.C

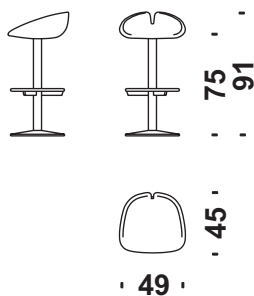

 m 1  m² 1,2  Kg 30  m³ 0,8

Cod. 114 Sgabello gir.base quadra opz. C-E

Bar stool sw.square base opt. C-E
Barhock.drehbar vier.Gestell var.C-E
Tabouret bar piv.base carré opt.C-E

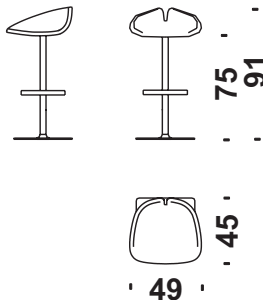

 m 1  m² 1,2  Kg 30  m³ 0,4

Cod. 116 Barra 4 posti opzioni C

Beam 4 seat options C
Modular System 4-sitz var.C
Poutre 4 places option C

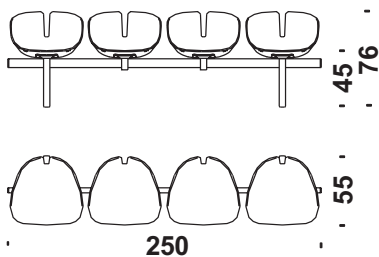

 m 5,6  m² 8,8  Kg 44  m³ 1,6

Cod. 117 Barra 5 posti opzioni C

Beam 5 seat options C
Modular System 5-sitz var.C
Poutre 5 places option C

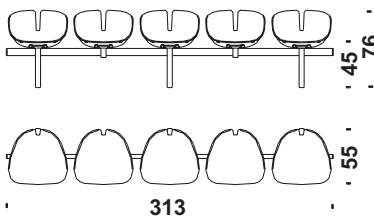

 m 7  m² 11  Kg 55  m³ 1,9

Cod. 119 Barra 4p 1 tavolo opzioni C

Beam 4 seat 1 table options C
Modular System 4-S.1Tisch var.C
Poutre 4 pl.1 table option C

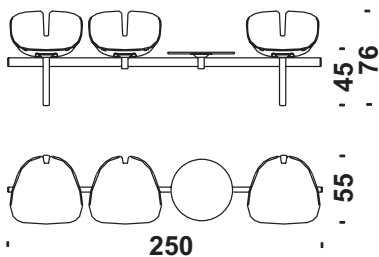

 m 4,2  m² 6,6  Kg 36  m³ 1,6

Cod. 120 Barra 5p 1 tavolo opzioni C

Beam 5 seat 1 table options C
Modular System 5-S.1Tisch var.C
Poutre 5 pl.1 table option C

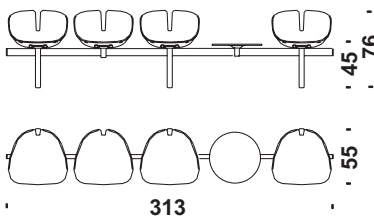

 m 5,6  m² 8,8  Kg 47  m³ 1,9

 **Fodera**
Ersatzbez

Cover
Housse

 m **Tessuto**
Stoff

Fabric
Tissu

 m² **Pelle**
Leder

Leather
Cuir

 Kg **P. lordo**
Bruttogew.

Gr. Weight
Poids Brut

 m³ **Volume**
Volumen

Volume
Volume

Cod. 0S1

Tavolo tondo

Round table
Tisch rund
Table rond

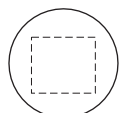

80

 Kg 25

 m³ 0,5

Cod. 016

Tavolo Bistrot tondo; min.50 pezzi

Round table Bistrot; min.50 pieces
Tisch rund Bistrot; min.50 stuck
Table rond Bistrot; min.50 pieces

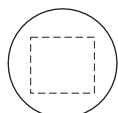

80

 Kg 25

 m³ 0,5

Cod. 06P

Tavolo quadro

Square table
Viereckiger tisch
Table carré

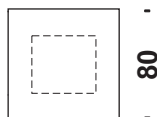

80

 Kg 25

 m³ 0,5

Cod. 0GR

Tavolo Bistrot quadro; min.50 pezzi

Square table Bistrot; min.50 pieces
Tisch viereckiger Bistrot; min.50 stuck
Table carré Bistrot; min.50 pieces

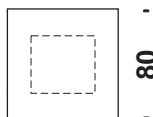

80

 Kg 25

 m³ 0,5

Cod. 0SA

Tavolo tondo grande

Round table large
Tisch rund gross
Table rond grand

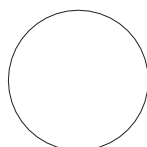
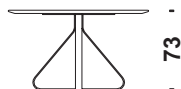

130

 Kg 125

 m³ 2

Cod. 0S2

Tavolo rettangolare

Rectangular table
Rechteckiger Tisch
Table

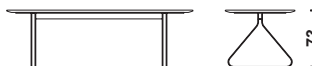

90

240

 Kg 200

 m³ 2,8