

Attenzione Per l'unione degli elementi sono previsti dei dispositivi di fissaggio, senza alcuna maggiorazione, diversi tra di loro, in relazione alla destinazione d'uso.

Attention Elements can be connected without upcharge. Different connectors are supplied for residential or public area use; please specify type on order.

Achtung Fixierungselemente sind ohne Preiszuschlag vorgesehen. Je nach Endbestimmung (Öffentlich od. Privatbereich), werden sie verschieden sind.

Attention Pour unir les éléments entre eux sont prévus des éléments de fixation différents, sans augmentation de prix, par rapport à l'utilisation du Waiting.

Legenda - Description

- 1 6 -9-10-11: Poliuretano a densità e portanza differenziate
6 -9-10-11: Polyurethane foam in varied densities
6 -9-10-11: Polyurethanschaum in untersch. Raumdichtigkeiten
6 -9-10-11: Mousse polyuréth. à densités différenciées
- 2 Ovatta poliestere da 200 gr/mq.
Polyester fiberfill 200 gr/mq.
Polyesterwatte mit 200 gr/mq.
Fibre polyester à 200 gr/mq.
- 3 Struttura in acciaio
Steel frame
Stahlstruktur
Structure en acier
- 4 Piede in alluminio
Aluminum legs
Füss aus Aluminium
Pied aluminium
- 5 Struttura schienale in acciaio
Back frame steel
Stahlstruktur Rückenstütze
Structure du dossier en acier
- 7 Struttura controschienale in acciaio
Back surround frame steel
Stahlstruktur Rückenstütze
Structure du contre dossier en acier
- 8 Piedino per regolazione livello
Height-adjustable glides
Füss regulierbar auf Bodenniveau
Pied pour regulation à niveau

Struttura

Acciaio rivestito con poliuretano espanso ignifugo indeformabile a densità differenziate e fibra poliestere.

Piedi

I piedi sono in pressofusione di alluminio lucidato M3141, regolabili in altezza.

Sovrapprezzi

Nel caso di elementi connessi, il cuscino dello schienale può essere prolungato fino alla fine del controschienale, su un lato o su entrambi.

Il prezzo aggiuntivo, per un solo lato, è di 110 €.

Caratteristiche

Il modello WAITING non è sfoderabile.
Si compone di elementi con e senza schienale.

Structure

Stress-resistant flame-retardant polyurethane foam in varied densities and polyester fiberfill on steel frame.

Feet

Polished die-cast aluminum M3141 feet are height-adjustable.

Surcharge

For connected units: with surcharge of 110 € (for one side only), back cushion can be produced in the same length as the back surround, on one side or both sides.

Spec. Characteristics

WAITING covers are not removable.
The collection can be delivered with or without back surround.

Struktur

Aus Stahl, mit feuerhemmendem unverformbarem Polyurethanschaum in unterschiedlichen Raumdichtigkeiten und Polyesterwatte.

Füsse

Die Füsse sind aus poliertem Aluminium-Druckguss M3141. Sie sind verstellbar.

Aufpreis

Falls die Elemente miteinander verbunden werden, kann der Rückenpolster auf die gleicher Länge der Rückenstütze gefertigt werden. Bitte angeben ob eine oder beide Seiten.
Aufpreis für eine Seite 110 €.

Besonderheiten

Das Modell WAITING ist nicht abziehbar.
Die Kollektion besteht aus Ausfuehrungen.

Structure

En acier recouverte de mousse polyuréthane indéformable ignifugée à densités différenciées et ouatte syntétique.

Pieds

Les pieds sont en pression d'aluminium brillant M3141, réglable en hauteur.

Suppl. de prix

Dans le cas où les éléments sont unis entre eux, le coussin du dossier peut être prolongé à la même longueur que le contredossier, ce la peut être effectué sur un côté ou sur les deux. Ajoutez SVP 110 € pour un côté.

Caractéristiques

Le modèle WAITING n'est pas déhoussable.
Il est prévu des versions avec ou sans dossier.

 **Fodera**
Ersatzbez

Cover
Housse

 m **Tessuto**
Stoff

Fabric
Tissu

 m² **Pelle**
Leder

Leather
Cuir

 Kg **P. lordo**
Bruttogew.

Gr. Weight
Poids Brut

 m³ **Volume**
Volumen

Volume
Volume

Cod. 04A

Elemento 1p cm.75

1 seater element cm.75
Element 1-Sitzig cm.75
Chaufeuse cm.75

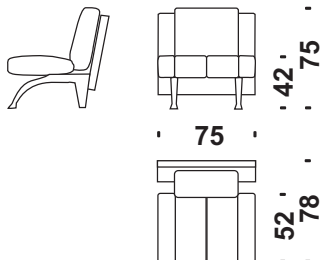

 m 2,7

 m² 5

 Kg 45

 m³ 0,6

Cod. 04B

Elemento 1p cm.100

1 seater element cm.100
Element 1-Sitzig cm.100
Chaufeuse cm.100

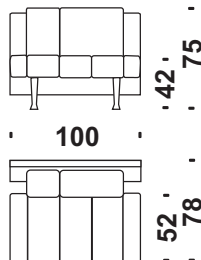

 m 3,5

 m² 6

 Kg 54

 m³ 0,9

Cod. 04C

Elemento 1p cm.125

1 seater element cm.125
Element 1-Sitzig cm.125
Chaufeuse cm.125

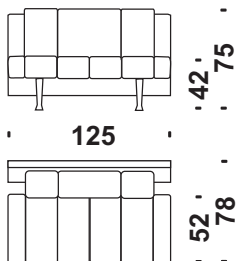

 m 4,4

 m² 7,5

 Kg 60

 m³ 1,2

Cod. 04D

Elemento 2p cm.200

2 seater element cm.200
Element 2-Sitzig cm.200
Canape 2 places cm.200

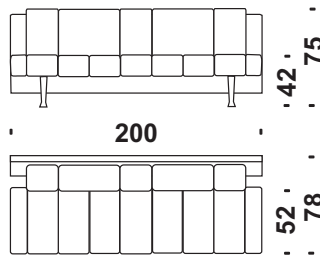

 m 6,4

 m² 11

 Kg 85

 m³ 1,5

Cod. 04E

Elemento 3p cm.275

3 seater element cm.275
Element 3-Sitzig cm.275
Canape 3 places cm.275

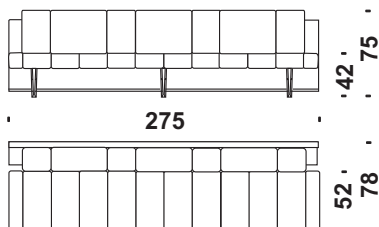

 m 8,7

 m² 16,5

 Kg 100

 m³ 2,4

Cod. 04F

Elem.2p 200 senza schien.

Bench 200 without backrest
Elem.2-Stz.200 ohne Rückenlehne
Banquette 200 sans dos

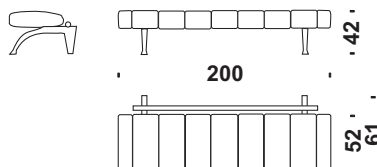

 m 2,7

 m² 5

 Kg 44

 m³ 0,75

Fodera
Ersatzbez

Cover
Housse

m **Tessuto**
Stoff

Fabric
Tissu

m² **Pelle**
Leder

Leather
Cuir

Kg **P. lordo**
Bruttogew.

Gr. Weight
Poids Brut

m³ **Volume**
Volumen

Volume
Volume

Cod. 04G

Elem.3p 275 senza schien.

Bench 275 without backrest
Elem.3-Stz.275 ohne Rückenlehne
Banquette 275 sans dos

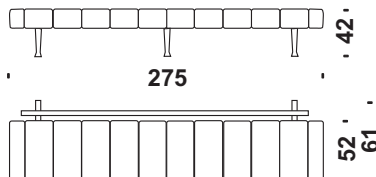

m 3,5

m² 6,5

Kg 50

m³ 1,3

Cod. 0P9

Panca doppia da cm.125

Double face bench-cm.125
Double face Bank-cm.125
Banquette double face-cm.125

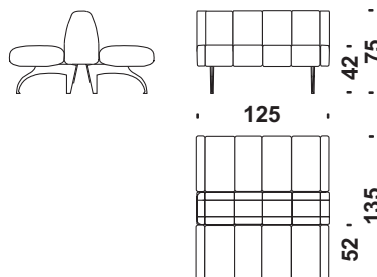

m 6

m² 11

Kg 80

m³ 1,7

Cod. 0T3

Panca doppia da cm.200

Double face bench-cm.200
Double face Bank-cm.200
Banquette double face-cm.200

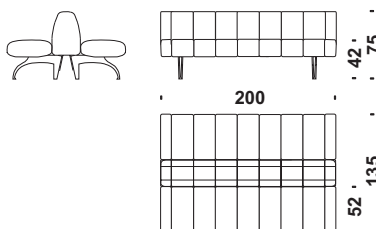

m 9,9

m² 18,8

Kg 110

m³ 2,6

Cod. 0U1

Panca doppia da cm.275

Double face bench-cm.275
Double face Bank-cm.275
Banquette double face-cm.275

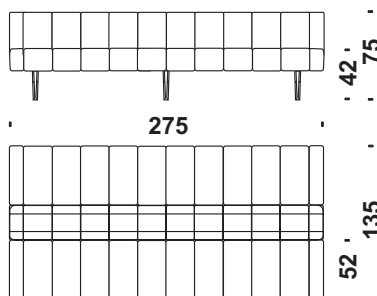

m 12,2

m² 23,2

Kg 130

m³ 3,8

Cod. 0S9

Elemento semicerchio

Half circle element
Halb Kreis Element
Élément demi-cercle

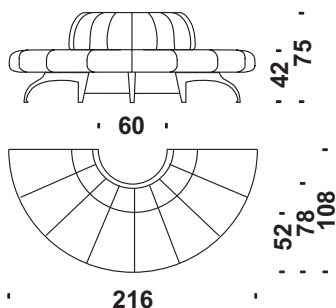

m 7,5

m² 14

Kg 85

m³ 2

Cod. 04H

Angolo chiuso

Closed corner
Geschlossene Ecke
Angle fermé

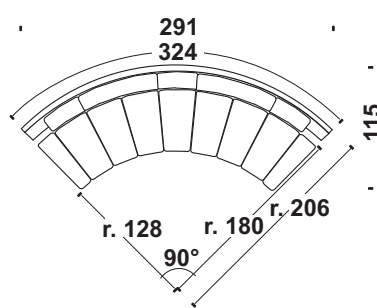





m 10,5

m² 19,8

Kg 90

m³ 2,9

 Fodera Ersatzbez	Cover Housse	 m Tessuto Stoff	Fabric Tissu	 m ² Pelle Leder	Leather Cuir	 Kg P. lordo Bruttogew.	Gr. Weight Poids Brut	 m ³ Volume Volumen	Volume Volume
---	------------------------	---	------------------------	--	------------------------	--	---------------------------------	---	-------------------------

Cod. 04I

Angolo aperto

Open corner
Offene Ecke
Angle ouvert

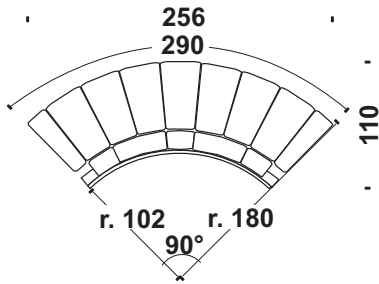

 m 7,3  m² 13,2  Kg 90  m³ 2,2

Cod. 04L

Angolo chiuso s/schienale

Closed corner without backrest
Geschlossene Ecke ohne Rück.
Angle fermé sans dos

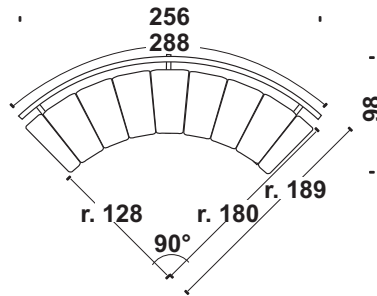

 m 3,3  m² 7,2  Kg 50  m³ 1,2

Cod. 04M

Angolo aperto s/schienale

Open corner without backrest
Offene Ecke ohne Rückenlehne
Angle ouvert sans dos

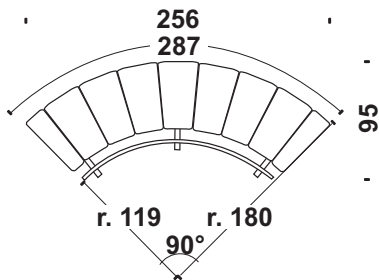

 m 3,3  m² 7,1  Kg 50  m³ 1,2