

**Attenzione** I prezzi indicati a listino sono del solo fusto e del cuscino di seduta. Il prezzo totale dell'articolo si ottiene aggiungendo al prezzo del fusto quello dei cuscini di schiena nelle quantità desiderate dal cliente. I cuscini tratteggiati indicano le quantità suggerite dall'azienda.

**Attention** Sofa and element prices do not include loose back cushions; add prices of loose back cushions for total price. Loose back cushions as shown in the drawings are only a suggestion of how many may be used.

**Achtung** Die angegebenen Preise beziehen sich nur auf das Gestell und die Sitzkissen. Bitte nicht vergessen die Anzahl der Rückenlehnen anzugeben, die Menge der schraffierten Rückenlehnen ist nur als Empfehlung von Moroso zu betrachten.

**Attention** Les prix indiqués se réfèrent à la structure et aux coussins de l'assise. Le prix final s'obtient en y ajoutant le prix des coussins du dossier. Commandes dans la quantité désirée par le client. Le nombre de coussins du dossier en pointilles est indicatif et conseillé par Moroso.

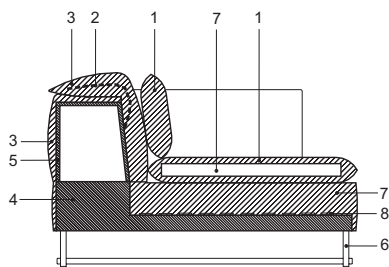

## Legenda - Description

- 1 Piumino d'oca  
Goose down  
Daune  
Duvet d'oie
- 2 Meccanismo in acciaio, reclinabile  
Internal steel articulating mechanism  
Verstellbares Stahlmechanismus  
Mécanisme en acier, réglable
- 3 Schiuma poliuretana flessibile  
Flexible polyurethane foam density 60 Kg/mc.  
Flexibler Polyurethanschaum,  
Dichtigkeit 60 Kg/mc.  
Mousse en polyuréthane flexible à densité 60 Kg/mc.
- 4 Struttura in legno  
Hardwood frame  
Holzstruktur  
Structure en bois
- 5 Struttura in acciaio  
Steel frame  
Stahlstruktur  
Structure en acier
- 6 Piedi in acciaio cromato o verniciato  
Feet steel with varnished or chrome finish  
Füsse in lackiert oder verchromt  
Stahl  
Pieds en acier vernis ou chromée
- 7 Poliuretani a densità e portanza differenziate  
Polyurethane foam in varied densities  
Polyurethanschaum in untersch.  
Raumdichtigkeiten  
Mousse polyuréth. à densités différenciées
- 8 Cinghie elastiche da 60 mm.  
Elastic belts 60 mm.  
Elastische Gurte 60 mm.  
Sangles élastiques de 60 mm.

## Struttura

Sedile in legno rivestito con pol. espanso a densità differenziate e fibra poliester. Sch.e bracc.in espanso schiumato a freddo ignifugo con struttura e mecc. d'inclinazione in acciaio, rivestiti in fibra poliester. TAVOLINI cod.242-243-244: piano in lamiera d'acciaio e base in tondino d'acciaio verniciata a polvere. TAVOLO cod.445: base in tondino d'acciaio verniciato a polvere con piano in alluminio alveolare laccato. Colori basi: rosso RAL 3031, verde RAL 6002, viola RAL 4007, nero RAL 9005 e bianco RAL 9003. TAVOLO cod.446: base in tondino d'acciaio verniciata a polvere bianco o nero. Piano in vetro verniciato bianco o nero. TAVOLO cod.240: piano in MDF laccato lucido. Piedi in acciaio verniciato nero opaco o cromato. TAVOLINI cod.342-343: piano e base in acciaio cromato lucido.

## Imbottitura cuscini

I cuscini del sedile sono in piuma d'oca con inserto in pol. espanso. I cuscini dello sch. e quello opt.sono in piuma d'oca o a richiesta in fibra poliester.

## Piedi

Piedi in acciaio verniciato nero opaco o cromato. Sottopiedi in polipropilene.

## Caratteristiche

La collezione SHANGHAI TIP è completamente sfoderabile.

## Structure

Seat is stress-resistant polyur. foam in varied densities and polyester fiberfill on hardwood frame. Back and armr. are injected flame-retardant cold foam polyur. and polyester fiberfill over internal steel frame with articulating mechanism TABLES code 242-243-244: base is steel rod with powdercoat finish. Top is steel plate with powdercoat finish. TABLE code 445: base is steel rod with powdercoat finish. Top is lacqu. aluminum. Bases colors: red RAL 3031, green RAL 6002, violet RAL 4007, black RAL 9005 and white RAL 9003. TABLE code 446: base is steel rod with black or white powdercoat finish. Top is white or black lacquered glass. TABLE code 240: base is tubular steel with black matt varnish or chrome finish. Top is MDF with glossy lacquer finish. Polypropylene glides. TABLES code 342-343: base is steel rod with polished chrome finish. Top is steel plate with polished chrome finish.

## Padding

Seat cushions are in goose down over polyurethane foam. Back cushions and optional pillow are goose down, or can be specified in polyester fiberfill without upcharge.

## Feet

Feet are tubular steel with black matt or chrome finish. Polypropylene glides.

## Struktur

Sitz aus Holz, mit unverformbarem Polyurethan.in unterschiedlichen Raumgewichte gepolstert und mit Polyesterwatte umhüllt. Ruecken und Arml. aus Stahl feuerhemmendem mechanismus und Polyesterwatte mit endlos verstellbaren Mechanismus. TISCHEN Kod.242-243-244: platte aus Stahl und Gestell aus Stahlrohr pulverbeschichtet. TISCH Kod.445: gestell aus Stahlrohr pulverbeschichtet. Tischplatte e aus Aluminium lackiert. Farben Gestell: rot RAL 3031, gruen RAL 6002, violet RAL 4007, schwarz RAL 9005 und weiss RAL 9003. TISCH 446: gestell aus Stahlrohr pulverbeschichtet weiss oder schwarz. Tischplatte aus Glas lackiert weiss oder schwarz. TISCH Kod.240: platte aus MDF hochglanz lackiert. Füsse in lackiert schwarz matt oder verchromt Stahl. TISCHEN Kod. 342-343: platte und Gestell aus in Chromstahl.

## Kissen Füllung

Sitzkissen in Daune mit einlage in Polyureth. Rückenlehnen und Opt. Kissen in Daune oder Anfrage in Polyesterwatte.

## Füsse

Füsse in lackiert schwarz matt oder verchromt Stahl.

## Besonderheiten

Kollektion SHANGHAI TIP ist komplett abziehbar.

## Structure

Assise en bois recouverte de mousse polyuréthane indéf. à densités différenciées et ouatte syntétique. Dossier et accoud.en acier enrobée dans la mousse ignifugée injectée a froid et ouatte synthétique avec mécanisme réglable. TABLES cod.242-243-244: plateau en acier et base en tube d'acier véni. TABLE cod.445: base en tube d'acier véni. Plateau en aluminium alvéolaire lacqué. Base couleurs: rouge RAL 3031, vert RAL 6002, violet RAL 4007, noir RAL 9005 et blanc RAL 9003. TABLE cod.446: base en tube d'acier véni blanc ou noir. Plateau en verre véni blanc ou noir. TABLE cod.240: plateau en MDF lacqué brillant. Pieds en acier vernis noir mat ou chromée. TABLES cod.342-343: plateau et base sont en acier chromé.

## Rembourrage

Les couss. de l'assise sont en plume d'oie avec emboîtement en mousse de polyuréthane. Les couss. du doss. et opt. sont en plume d'oie ou sur demande en fibre polyester.

## Pieds

Pieds en acier vernis noir mat ou chromée. Sous-pieds en polypropylène.

## Caractéristiques

La collection SHANGHAI TIP est complètement déhoussable.

Fodera Cover m Tessuto Fabric m<sup>2</sup> Pelle Leather Kg P. lordo Gr. Weight m<sup>3</sup> Volume Volume  
 Ersatzbez Housse Stoff Tissu Leder Cuir Bruttogew. Poids Brut Volumen Volumen

**Cod. 018** **Divano 2 posti major**  
 2 seater sofa major  
 Sofa 2-Sitzig Major  
 Canapé 2 places major

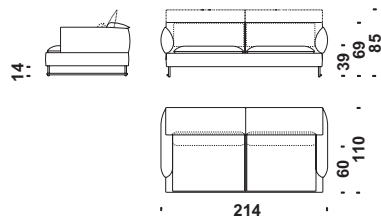

m 11,5 m<sup>2</sup> 21 Kg 100 m<sup>3</sup> 1,7

**Cod. 003** **Divano 3 posti**  
 3 seater sofa  
 Sofa 3-Sitzig  
 Canapé 3 places

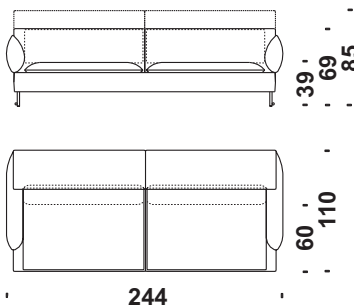

m 12 m<sup>2</sup> 22 Kg 108 m<sup>3</sup> 2,1

**Cod. 04A** **Elemento 1p centrale 75**  
 Central element 75  
 Zentralelement 75  
 Élément central 75

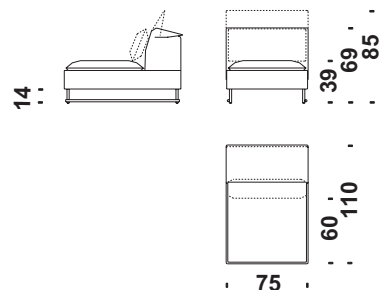

m 4,5 m<sup>2</sup> 8 Kg 45 m<sup>3</sup> 0,65

**Cod. 011** **Elemento 1p centrale 100**  
 Central element 100  
 Zentralelement 100  
 Élément central 100

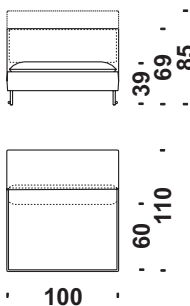

m 5,5 m<sup>2</sup> 9,1 Kg 50 m<sup>3</sup> 0,85

**Cod. 04P** **Elemento 2p centrale 150**  
 2 seat central element 150  
 Zentralelement 2-sitzig 150  
 Élément central 2 places 150

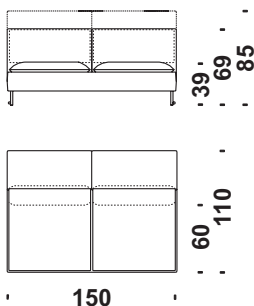

m 8,9 m<sup>2</sup> 17,5 Kg 85 m<sup>3</sup> 1,2

**Cod. 04D** **Elemento 2p centrale 200**  
 2 seat central element 200  
 Zentralelement 2-sitzig 200  
 Élément central 2 places 200

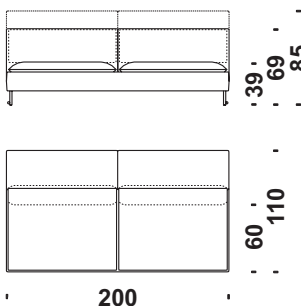

m 10 m<sup>2</sup> 18 Kg 90 m<sup>3</sup> 1,7

 **Fodera**  
Ersatzbez

Cover  
Housse

 m **Tessuto**  
Stoff

Fabric  
Tissu

 m<sup>2</sup> **Pelle**  
Leder

Leather  
Cuir

 Kg **P. lordo**  
Bruttogew.

Gr. Weight  
Poids Brut

 m<sup>3</sup> **Volume**  
Volumen

Volume  
Volume

**Cod. 025**

**Elemento 1p sinistro 82**

Lateral 1seat unit left 82  
Seiten Element links 82  
Elément latérale gauche 82

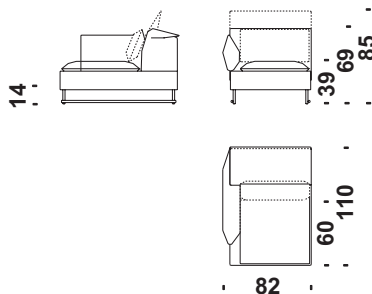

 m 5  m<sup>2</sup> 9,3  Kg 50  m<sup>3</sup> 0,7

**Cod. 024**

**Elemento 1p destro 82**

Lateral 1seat unit right 82  
Seiten Element rechts 82  
Elément latérale droit 82

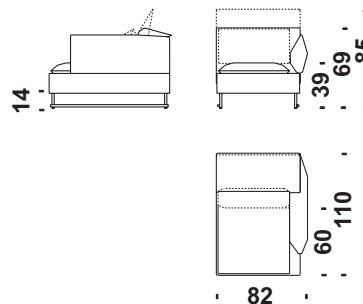

 m 5  m<sup>2</sup> 9,3  Kg 50  m<sup>3</sup> 0,7

**Cod. 013**

**Elemento 1p sinistro 107**

Lateral 1seat unit left 107  
Seiten Element links 107  
Elément latérale gauche 107

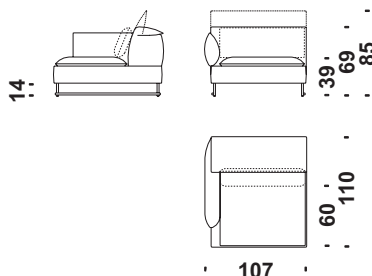

 m 6  m<sup>2</sup> 11  Kg 55  m<sup>3</sup> 0,85

**Cod. 012**

**Elemento 1p destro 107**

Lateral 1seat unit right 107  
Seiten Element rechts 107  
Elément latérale droit 107

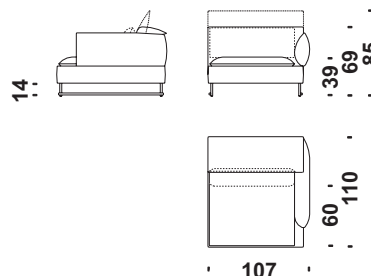

 m 6  m<sup>2</sup> 11  Kg 55  m<sup>3</sup> 0,85

**Cod. 039**

**Elemento 2p sinistro 157**

Lateral 2 seat unit left 157  
2-Sitz Element links 157  
Elément latérale gauche 157

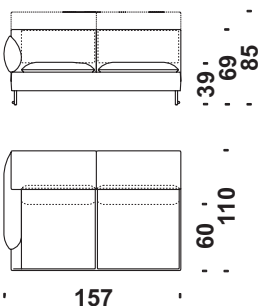

 m 9,7  m<sup>2</sup> 18,9  Kg 90  m<sup>3</sup> 1,4



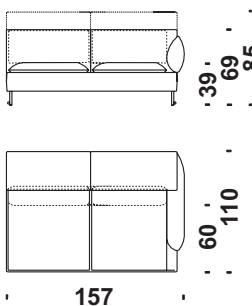

**Cod. 038**

**Elemento 2p destro 157**

Lateral 2 seat unit right 157  
2-Sitz Element rechts 157  
Elément latérale droit 157



 m 9,7  m<sup>2</sup> 18,9  Kg 90  m<sup>3</sup> 1,4

 **Fodera** Cover  **Tessuto** Fabric  **Pelle** Leather  **P. lordo** Gr. Weight  **Volume** Volume  
 Ersatzbez Housse Stoff Tissu Leder Cuir Bruttogew. Poids Brut Volumen Volumen

**Cod. 023** **Elemento 2p sinistro 207**

Lateral 2 seat unit left 207  
 2-Sitz Element links 207  
 Élément latérale gauche 207

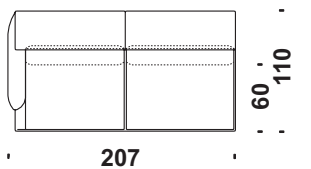
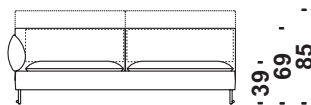

 m 11  m² 20  Kg 95  m³ 1,7

**Cod. 022** **Elemento 2p destro 207**

Lateral 2 seat unit right 207  
 2-Sitz Element rechts 207  
 Élément latérale droit 207

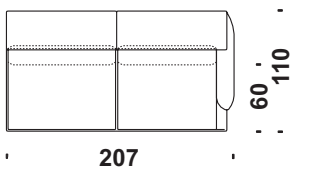
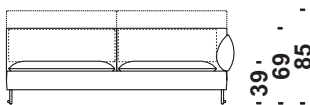

 m 11  m² 20  Kg 95  m³ 1,7

**Cod. 0TH** **Penisola 2p sinistra**

Lateral 2 seat left peninsula  
 2-Sitz Halbinsel links  
 Latérale péninsule gauche

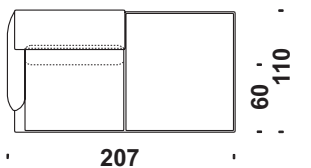
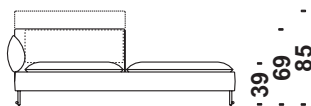

 m 9  m² 16,5  Kg 90  m³ 1,7

**Cod. 0TG** **Penisola 2p destra**

Lateral 2 seat right peninsula  
 2-Sitz Halbinsel rechts  
 Latérale péninsule droit

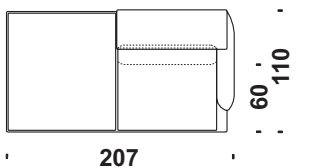
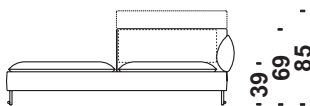

 m 9  m² 16,5  Kg 90  m³ 1,7

**Cod. 010** **Angolo**

Corner  
 Ecke  
 Angle

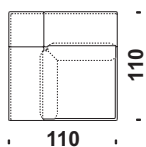
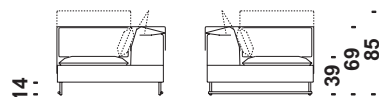



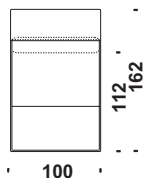
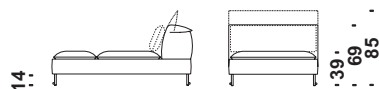

 m 7,5  m² 14,2  Kg 60  m³ 0,9

**Cod. 04S** **Chaise Longue centrale**

Chaise Longue central  
 Chaise Longue zentral  
 Chaise Longue central



 m 7,4  m² 11,8  Kg 60  m³ 1,2

 **Fodera** Cover  
 Ersatzbez Housse  
 m **Tessuto** Fabric  
 Stoff Tissu  
 m<sup>2</sup> **Pelle** Leather  
 Leder Cuir  
 Kg **P. lordo** Gr. Weight  
 Bruttogew. Poids Brut  
 m<sup>3</sup> **Volume** Volume  
 Volumen Volume

**Cod. 0D4 Chaise Longue sinistra**

Chaise Longue left  
Chaise Longue links  
Chaise Longue gauche

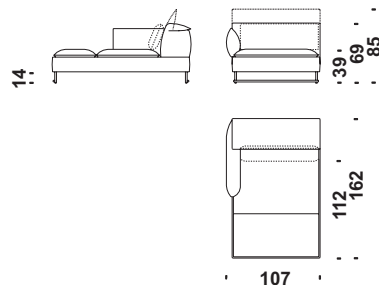

 m 7,7  
 m<sup>2</sup> 13,5  
 Kg 65  
 m<sup>3</sup> 1,35

**Cod. 0D3 Chaise Longue destra**

Chaise Longue right  
Chaise Longue rechts  
Chaise Longue droit

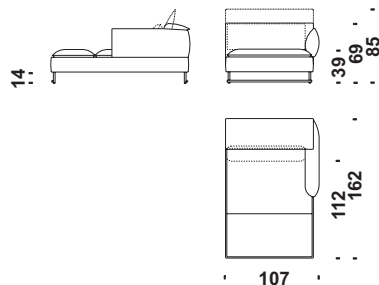

 m 7,7  
 m<sup>2</sup> 13,5  
 Kg 65  
 m<sup>3</sup> 1,35

**Cod. 280 Shanghai Tip pouf 100x50**

Shanghai Tip stool 100x50  
Shanghai Tip Hocker 100x50  
Shanghai Tip pouf 100x50

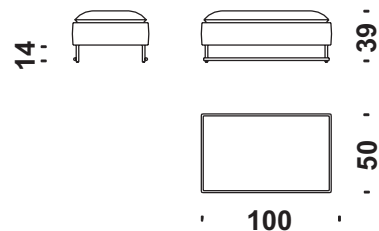

 m 2,4  
 m<sup>2</sup> 3,8  
 Kg 35  
 m<sup>3</sup> 0,35

**Cod. 017 Shanghai Tip pouf 107x50**

Shanghai Tip stool 107x50  
Shanghai Tip Hocker 107x50  
Shanghai Tip pouf 107x50

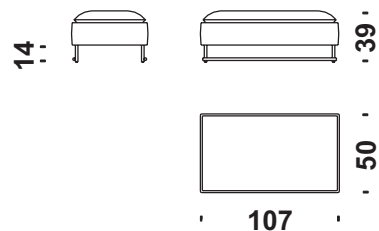

 m 2,4  
 m<sup>2</sup> 3,8  
 Kg 35  
 m<sup>3</sup> 0,35

**Cod. 077 Shanghai Tip pouf 107x107**

Shanghai Tip stool 107x107  
Shanghai Tip Hocker 107x107  
Shanghai Tip pouf 107x107

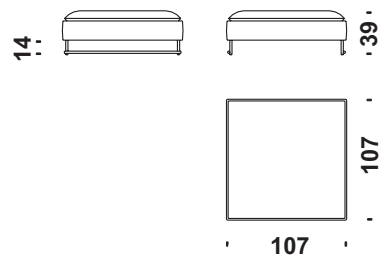

 m 4  
 m<sup>2</sup> 5,6  
 Kg 40  
 m<sup>3</sup> 0,5

**Cod. 0K5 Shanghai Tip cusc.schiene 68x45**

Shanghai Tip back cushion 68x45  
Shanghai Tip ruecken kissen 68x45  
Shanghai Tip coussin dos 68x45

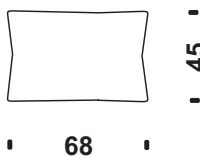

 m 1,1  
 m<sup>2</sup> 1,3

 **Fodera**  
Ersatzbez

Cover  
Housse

 m **Tessuto**  
Stoff

Fabric  
Tissu

 m<sup>2</sup> **Pelle**  
Leder

Leather  
Cuir

 Kg **P. lordo**  
Bruttogew.

Gr. Weight  
Poids Brut

 m<sup>3</sup> **Volume**  
Volumen

Volume  
Volume

**Cod. 0K4 Shanghai Tip cusc.schiena 90x45**

Shanghai Tip back cushion 90x45  
Shanghai Tip ruecken kissen 90x45  
Shanghai Tip coussin dos 90x45



**Cod. 0K6 Shanghai Tip cusc.sch.div.3p**

Shanghai Tip back cush.3 s.sofa  
Shanghai Tip ruecken kiss.sofa 3-sz.  
Shanghai Tip cous.dos can.3 pl.

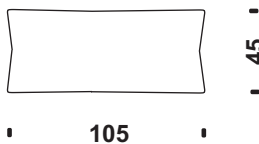

 m 1,1

 m<sup>2</sup> 1,3

 m 1,3

 m<sup>2</sup> 1,5

**Cod. 080 Shanghai Tip cuscino optional**

Shanghai Tip optional pillow  
Shanghai Tip optional Kissen  
Shanghai Tip coussin optionel

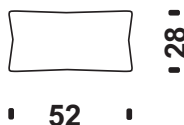

**Cod. 242 Tavolino acciaio verniciato 32x32x43**

Varnished steel table 32x32x43  
Tisch Stahl Lackiert 32x32x43  
Table acier vernis 32x32x43

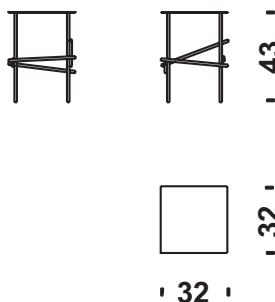

 m 0,7

 m<sup>2</sup> 0,8

 Kg 11

 m<sup>3</sup> 0,15

**Cod. 342 Tavolino acciaio cromato 32x32x43**

Chromed steel table 32x32x43  
Tisch Chromstahl 32x32x43  
Table acier chromé 32x32x43

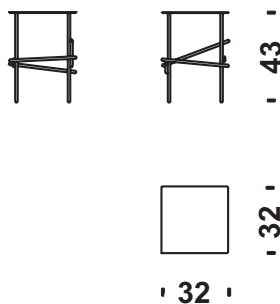

**Cod. 243 Tavolino acciaio verniciato D.35 H.48**

Varnished steel table D.35 H.48  
Tisch Stahl Lackiert D.35 H.48  
Table acier vernis D.35 H.48



 Kg 11

 m<sup>3</sup> 0,15

 Kg 11

 m<sup>3</sup> 0,15

**Fodera**  
Ersatzbez

Cover  
Housse

**Tessuto**  
Stoff

Fabric  
Tissu

**Pelle**  
Leder

Leather  
Cuir

**P. lordo**  
Bruttogew.

Gr. Weight  
Poids Brut

**Volume**  
Volumen

Volume  
Volume

**Cod. 343 Tavolino acciaio cromato D.35 H.48**

Chromed steel table D.35 H.48  
Tisch Chromstahl D.35 H.48  
Table acier chromé D.35 H.48



· 35 ·

Kg 11 m³ 0,15

**Cod. 244 Tavolino acciaio verniciato 64x53x38**

Varnished steel table 64x53x38  
Tisch Stahl Lackiert 64x53x38  
Table acier vernis 64x53x38



· 64 ·

Kg 15 m³ 0,15

**Cod. 446 Tavolo vetro 107x107x29**

Glass table 107x107x29  
Tisch glass 107x107x29  
Table en verre 107x107x29



· 107 ·

m 40 m² 0,4

**Cod. 445 Tavolo alluminio 107x107x29**

Aluminium table 107x107x29  
Tisch aluminium 107x107x29  
Table en aluminium 107x107x29

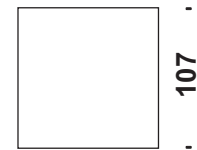

· 107 ·

m 40 m² 0,4

**Cod. 240 Tavolo 107x107x30**

Table 107x107x30  
Tisch 107x107x30  
Table 107x107x30

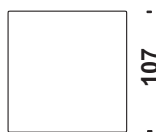

· 107 ·

Kg 35 m³ 0,5