

Attenzione NEL RIVESTIMENTO BICOLORE CUCITURE IN ABBINAMENTO SEDUTA ANTERIORE A VISTA.

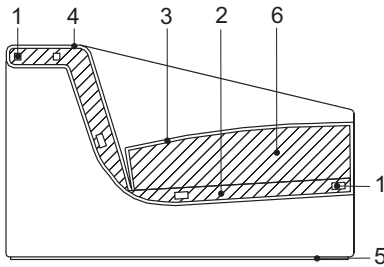

Attention FOR TWO-COLOR COVERS ALL TOP-STITCHING IS SAME COLOR AS SEAT/FRONT.

Achtung BEZUG ZWEIFARBIG, NAHTE ZUORDNUNG SITZFLAECHE.

Attention HOUSSE BICOLORE, COUTURES ASSORTIES AVEC TISSU ASSISE ANTERIEURE.

Legenda - Description

- 1 Struttura in acciaio
Steel frame
Stahlstruktur
Structure en acier
- 2 Schiuma poliuretana flessibile con densità 60 Kg/mc.
Flexible polyurethane foam density 60 Kg/mc.
Flexibler Polyurethanschaum, Dichtigkeit 60 Kg/mc.
Mousse en polyuréthane flexible à densité 60 kg/mc.
- 3 Ovatta poliestere da 100 gr/mq.
Polyester fiberfill 100 gr/mq.
Watte 100 gr/mq.
Fibre polyester a 100 gr/mq.
- 4 Rivestimento in tela di cotone 100%
100% cotton cover
Überzug aus Baumwolle 100%
Revêtement coton 100%
- 5 Piede in acciaio verniciato
Feet varnished steel
Fuesse aus lackiertem Stahl
Pied en acier verni
- 6 Poliuretani a densità e portanza differenziate
Polyurethane foam in varied densities
Polyurethanschaum in untersch. Raumdichtigkeiten
Mousse polyuréth. à densités différenciées

Struttura

Espanso schiumato a freddo ignifugo con struttura interna in acciaio.
Piedi in acciaio verniciato M3073.

TAVOLI:

Acciaio verniciato M3073.
Piano con spessore mm. 30 in poliuretano rigido laccato lucido e tinto bianco RAL 9016, rosso RAL 3020 e nero RAL 9005.
Piedi in inox. Sottopiede in polietilene

Imbottitura cuscini

I cuscini dello schienale sono in piuma d'oca

Caratteristiche

La collezione MALMÖ è sfoderabile.
In pelle è fissa.
I tavoli vengono consegnati smontati.

NON SI ACCETTANO ORDINI DI ELEMENTI FUORI MISURA.

Structure

Injected flame-retardant polyurethane foam over internal steel frame.
Feet are varnished steel M3073.

TABLES:

Base is varnished steel M3073.
Top, 30 mm / 1 1/8" thick, is rigid polyurethane with glossy finish, available white RAL 9016, red RAL 3020 and black RAL 9005.
Legs are stainless steel with polyethylene glides.

Padding

Back cushions are goose down.

Spec. Characteristics

MALMÖ fabric covers are removable.
Leather upholstery is fixed.
Tables are delivered unassembled.

REQUESTS FOR CUSTOM VERSIONS CANNOT BE ACCEPTED

Struktur

Das Modell bestehen aus einem Stahlgestell in feuerhemmendem kaltgeschäumtem Schaumstoff.
Fuesse aus lackiertem Stahl M3073.

TISCHE:

Stahl lackiert M3073.
Tischplatte, Dicke 30 mm., in festem Polyurethan Lackiert farbe weiss RAL 9016, rot RAL 3020 und schwarz RAL 9005.
Füsse aus Edelstahl.
Unterfüss in Polyethylen.

Kissen Füllung

Rückenkissen in Daune.

Besonderheiten

Kollektion MALMÖ ist abziehbar.
Lederausführung ist fix.
Die Tische werden abmontiert geliefert.

SONDERANFERTIGUNGEN KOENNEN NICHT AUSGEFUEHRT WERDEN.

Structure

En acier enrobée dans la mousse ignifugée injectée a froid.
Pieds en acier verni M3073.

TABLES:

En acier verni M3073.
Plan, épaisseur 30 mm., en polyuréthane rigide, lacqué brillant couleur blanc RAL 9016, rouge RAL 3020 et noir RAL 9005.
Pieds en acier inoxydable.
Sous-pieds en polyethylene.





Rembourrage

Les coussins du dossier sont en duvet.

Caractéristiques

La collection MALMÖ est déhoussable.
En cuir fixe. Les tables sont livrées démontées.

COMMANDES HORS MESURE NE SONT PAS ACCEPTÉES.

 **Fodera** Cover  **Tessuto** Fabric  **Pelle** Leather  **P. lordo** Gr. Weight  **Volume** Volume
 Ersatzbez Housse Stoff Tissu Leder Bruttogew. Poids Brut Volumen Volumen

Cod. 0V0

Divano 2p con cuscini

2 seater sofa with cushions
 Sofa 2-Sitzig mit Kissen
 Canapé 2 places avec coussins

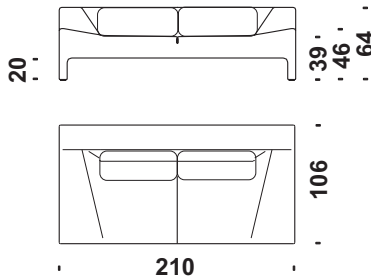

 m 9,7  m² 18,5  Kg 96  m³ 1,6

Cod. 0V4

Divano 2p major con cusc.

2 seater sofa major with cushions
 Sofa 2-Sitzig major mit Kissen
 Canapé 2 places major avec couss.

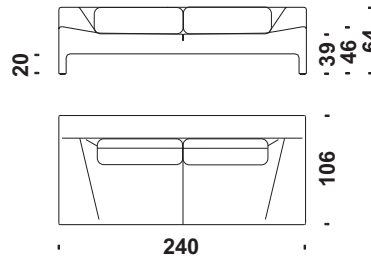

 m 11,2  m² 21  Kg 101  m³ 1,9

Cod. 0V5

Divano 3p con cuscini

3 seater sofa with cushions
 Sofa 3-Sitzig mit Kissen
 Canapé 3 places avec coussins

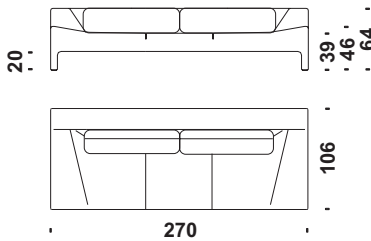

 m 12,6  m² 23,6  Kg 108  m³ 2,1

Cod. 001

Poltrona

Armchair
 Sessel
 Fauteuil

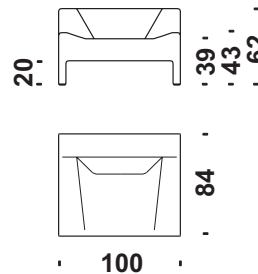

 m 4  m² 7  Kg 43  m³ 0,7

Cod. 036

Chaise Longue

Chaise Longue
 Chaise Longue
 Chaise Longue

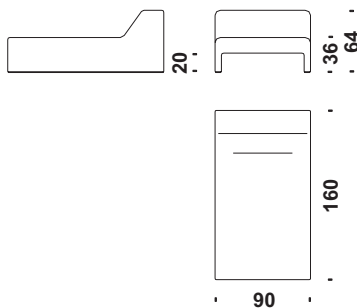

 m 5,1  m² 8,6  Kg 54  m³ 1

Cod. 0VA

Divano 2p pelle/tess.e cuscini

2 seat sofa leath/fabr.and cushions
 Sofa 2-Sz.leder/Stoff und Kissen
 Canapé 2 pl.cuir/tissu et coussins

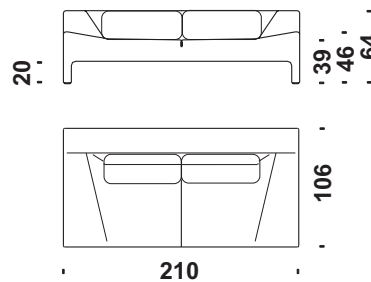

 m 3,3  m² 13  Kg 96  m³ 1,6

 **Fodera** Cover  **Tessuto** Fabric  **Pelle** Leather  **P. lordo** Gr. Weight  **Volume** Volume

Cod. 0VB

Divano 2pm pelle/tess.e cuscini

2 seat sofa major leath./fabr.and cush.
Sofa 2-Sz.major Leder/Stoff und Kiss.
Canapé 2 pl.major cuir/tissu et couss.

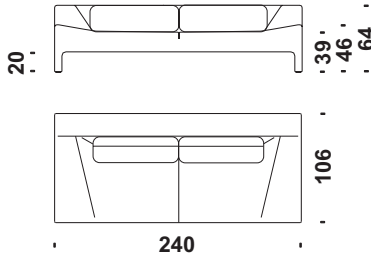

 m 3,6  m² 14,5  Kg 101  m³ 1,9

Cod. 0VC

Divano 3p pelle/tess.e cuscini

3 seat sofa leath/fabr.and cushions
Sofa 3-Sz.Leder/Stoff und Kissen
Canapé 3 pl.cuir/tissu et coussins

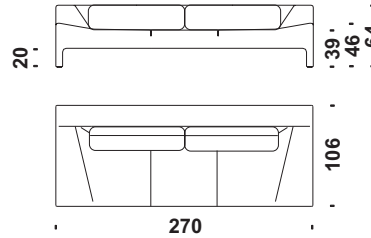

 m 3,9  m² 16,5  Kg 108  m³ 2,1

Cod. 0VE

Poltrona pelle/tessuto

Armchair leather/fabric
Sessel Leder/Stoff
Fauteuil cuir/tissu

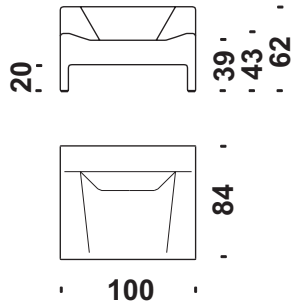

 m 1,7  m² 6  Kg 43  m³ 0,7

Cod. 0VD

Chaise Longue pelle/tessuto

Chaise Longue leather/fabric
Chaise Longue Leder/Stoff
Chaise Longue cuir/tissu

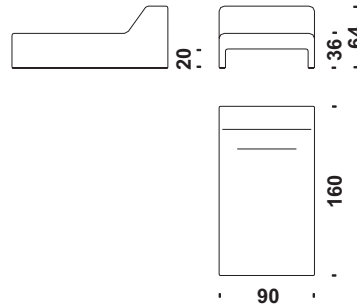

 m 2  m² 7  Kg 54  m³ 1

Cod. 0VF

Div.2p con 2 rivestimenti e cuscini

2 seat.sofa 2 upholsteries and cush.
Sofa 2-Sitzig 2 Ueberzuegen und Kiss.
Canape 2 pl. 2 revetements et couss.

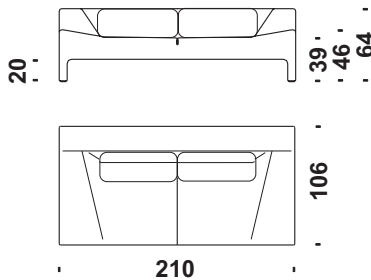

 m 6-3,3  Kg 96  m³ 1,6

Cod. 0VG

Div.2pm con 2 rivestimenti e cuscini

2 seat sofa mj 2 upholsteries and cush.
Sofa 2-Sz.mj 2 Ueberzuegen und Kiss.
Canape 2 pl.mj 2 revetements et couss.

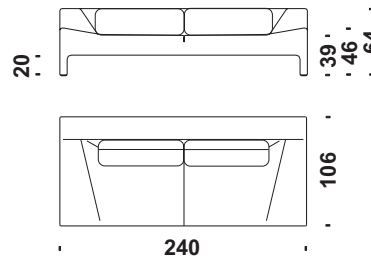

 m 7-3,6  Kg 101  m³ 1,9

Fodera
Ersatzbez
Cover
Housse

m

Tessuto
Stoff

Fabric
Tissu

m² Pelle
Leder

Leather
Cuir

Kg P. lordo
Bruttogew.

Gr. Weight
Poids Brut

m³ Volume
Volumen

Volume
Volume

Cod. 0VH **Div.3p con 2 rivestimenti e cuscini**

3 seat sofa 2 upholsteries and cush.
Sofa 3-Sitzig 2 Ueberzuegen und Kiss.
Canape 3 pl. 2 revetements et couss.

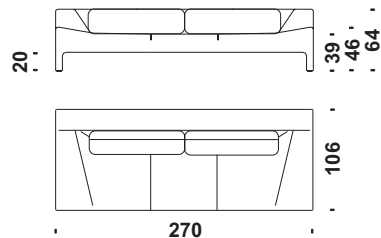

m 8-3,9

Kg 108

m³ 2,1

Cod. 0VL **Chaise Longue con 2 rivestimenti**

Chaise Longue with 2 upholsteries
Chaise Longue mit 2 Ueberzuegen
Chaise Longue avec 2 revetements

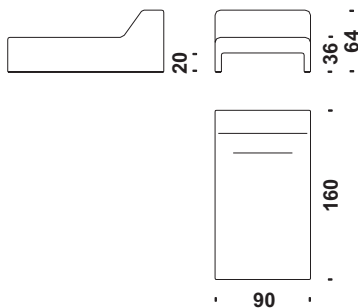

m 4,5-2

Kg 54

m³ 1

Cod. 0KU **Malmö cuscino 63x34**

Malmö cushion 63x34
Malmö Kissen 63x34
Malmö coussin 63x34

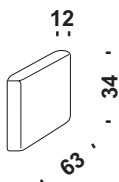

m 1,1

m² 1,4

Cod. 0VM **Poltrona con 2 rivestimenti**

Armchair with 2 upholsteries
Sessel mit 2 Ueberzuegen
Fauteuil avec 2 revetements

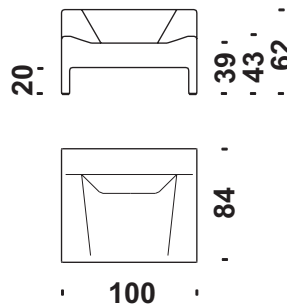

m 3-1,7

Kg 43

m³ 0,7

Cod. 017 **Malmö pouf**

Malmö stool
Malmö Hocker
Malmö pouf

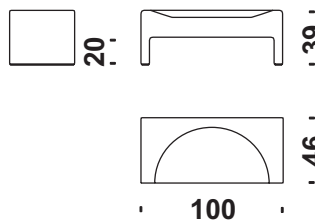

m 2,1

m² 3,8

Kg 17

m³ 0,3

Cod. 0KV **Malmö cuscino 78x34**

Malmö cushion 78x34
Malmö Kissen 78x34
Malmö coussin 78x34

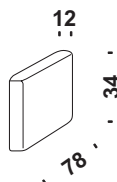

m 1,3

m² 1,7

Fodera
Ersatzbez

Cover
Housse

m Tessuto
Stoff

Fabric
Tissu

m² Pelle
Leder

Leather
Cuir

Kg P. lordo
Bruttogew.

Gr. Weight
Poids Brut

m³ Volume
Volumen

Volume
Volume

Cod. 0KY

Malmö cuscino 93x34

Malmö cushion 93x34
Malmö Kissen 93x34
Malmö coussin 93x34

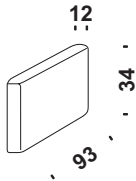

m 1,5

m² 2,1

Cod. 0CK

Tavolo 80x65x28

Table 80x65x28
Tisch 80x65x28
Table 80x65x28

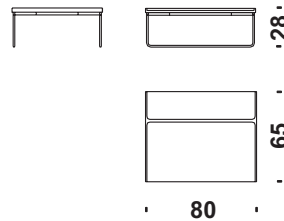

Kg 13

m³ 0,10

Cod. 0CL

Tavolo 80x130x28 tipo A

Table 80x130x28 type A
Tisch 80x130x28 tjp A
Table 80x130x28 tje A

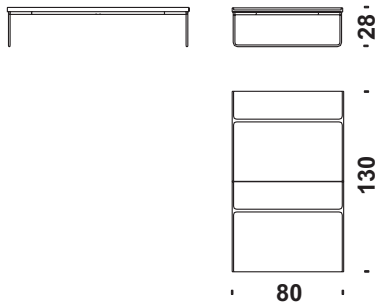

Kg 15

m³ 0,17

Cod. 0CQ

Tavolo 80x130x28 tipo B

Table 80x130x28 type B
Tisch 80x130x28 tjp B
Table 80x130x28 tje B

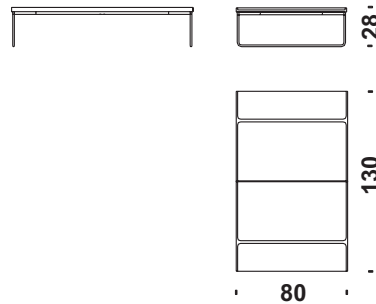

Kg 15

m³ 0,17

Cod. 0CT

Tavolo 80x130x28 tipo C

Table 80x130x28 type C
Tisch 80x130x28 tjp C
Table 80x130x28 tje C

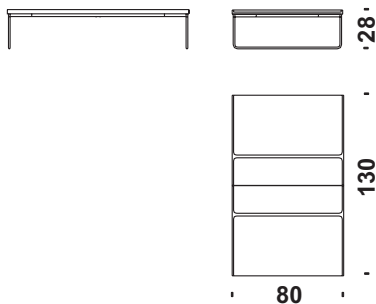

Kg 15

m³ 0,17