

## LED SCONCE

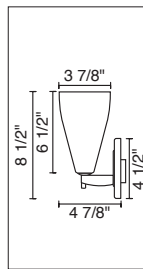

### ZARA SCONCE

- 102 151(bz,ch,mc)
- 102 152(bz,ch,mc)
- 102 153(bz,ch,mc)
- 102 154(bz,ch,mc)
- 102 156(bz,ch,mc)
- 102 157(bz,ch,mc)

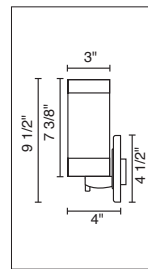

### SIERRA SCONCE

- 102 711(bz,ch,mc)
- 102 712(bz,ch,mc)
- 102 713(bz,ch,mc)
- 102 714(bz,ch,mc)
- 102 715(bz,ch,mc)
- 102 716(bz,ch,mc)

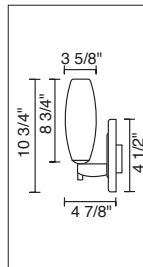

### CIRO SCONCE

- 102 116(bz,ch,mc)
- 102 119(bz,ch,mc)
- 102 121(bz,ch,mc)
- 102 122(bz,ch,mc)
- 102 123(bz,ch,mc)
- 102 124(bz,ch,mc)
- 102 125(bz,ch,mc)

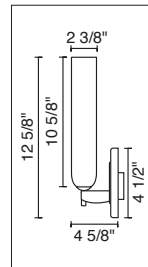

### CHIANTI SCONCE

- 102 820(bz,ch,mc)
- 102 821(bz,ch,mc)
- 102 822(bz,ch,mc)
- 102 823(bz,ch,mc)

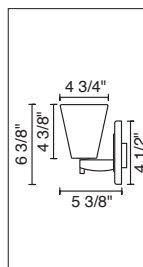

### BLING I SCONCE

- 102 168(bz,ch,mc)
- 102 173(bz,ch,mc)
- 102 178(bz,ch,mc)
- 102 840(bz,ch,mc)
- 102 841(bz,ch,mc)
- 102 842(bz,ch,mc)

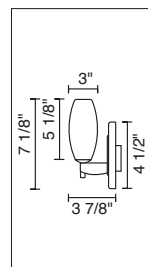

### CIRO MINI SCONCE

- 102 830(bz,ch,mc)
- 102 831(bz,ch,mc)
- 102 832(bz,ch,mc)
- 102 833(bz,ch,mc)

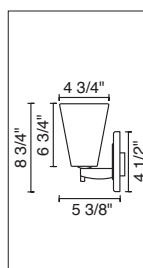

### BLING II SCONCE

- 102 169(bz,ch,mc)
- 102 174(bz,ch,mc)
- 102 179(bz,ch,mc)
- 102 843(bz,ch,mc)
- 102 844(bz,ch,mc)
- 102 845(bz,ch,mc)

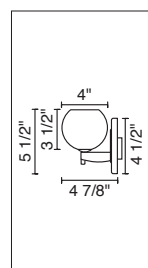

### BOBO SCONCE

- 102 915(bz,ch,mc)
- 102 917(bz,ch,mc)

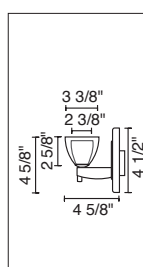

### RAINBOW I SCONCE

- 102 721(bz,ch,mc)
- 102 722(bz,ch,mc)
- 102 723(bz,ch,mc)
- 102 724(bz,ch,mc)
- 102 913(bz,ch,mc)
- 102 918(bz,ch,mc)

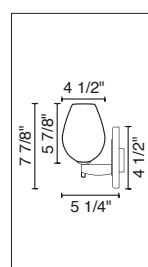

### BOLERO SCONCE

- 102 336(bz,ch,mc)
- 102 337(bz,ch,mc)
- 102 338(bz,ch,mc)
- 102 339(bz,ch,mc)

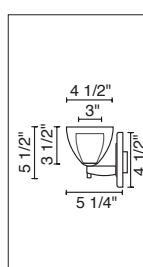

### RAINBOW II SCONCE

- 102 725(bz,ch,mc)
- 102 726(bz,ch,mc)
- 102 728(bz,ch,mc)
- 102 729(bz,ch,mc)
- 102 816(bz,ch,mc)
- 102 817(bz,ch,mc)
- 102 916(bz,ch,mc)
- 102 919(bz,ch,mc)

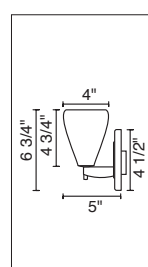

### LUCY SCONCE

- 102 126(bz,ch,mc)
- 102 127(bz,ch,mc)
- 102 128(bz,ch,mc)

## LED SCONCE

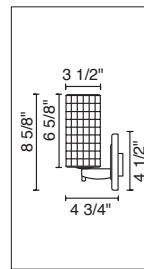

### SIERRA SCONCE

- 102 114bz
- 102 114ch
- 102 114mc

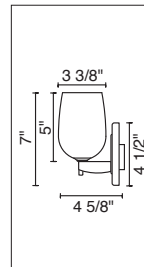

### QUEENY I SCONCE

- 102 321(bz,ch,mc)
- 102 322(bz,ch,mc)
- 102 323(bz,ch,mc)
- 102 324(bz,ch,mc)
- 102 325(bz,ch,mc)
- 102 370(bz,ch,mc)
- 102 371(bz,ch,mc)
- 102 372(bz,ch,mc)
- 102 373(bz,ch,mc)

## LED SCONCE

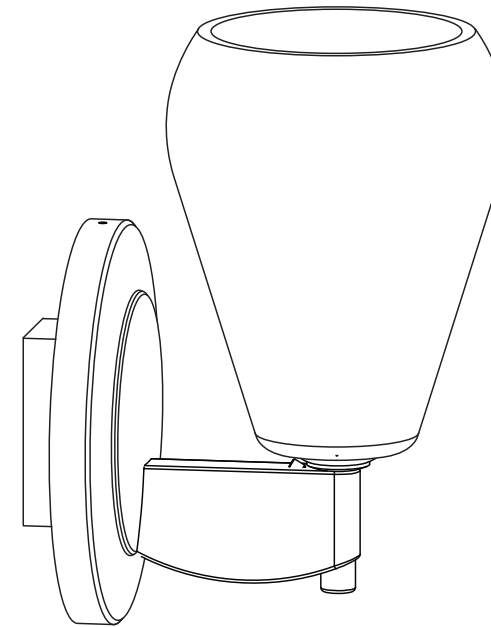

### TECHNICAL SPECIFICATIONS

Description: 4" Canopy with J-Box and Glass  
Design: Bruck-Team  
Lamp: 3 Watt LED

### CONTENTS OF DELIVERY

fixture complete



### IMPORTANT SAFETY INSTRUCTIONS



1. Save these instructions and refer to them when additions to or changes to the fixture are made.
2. THIS PRODUCT MUST BE INSTALLED BY A PERSON FAMILIAR WITH THE CONSTRUCTION AND OPERATION OF THE PRODUCT AND THE HAZARDS INVOLVED, IN ACCORDANCE WITH THE APPLICABLE NEC CODE.
3. Do not install this fixture in damp or wet locations.
4. CAUTION - Do not install any fixture assembly closer than 6 inches from any curtain, or similar combustible material.
5. Turn off power prior to any work on the systems.
6. Warranty is void in case of unauthorized modifications and/ or improper use.

READ ALL OF THESE INSTRUCTIONS BEFORE INSTALLATION

## INSTALLATION INSTRUCTIONS

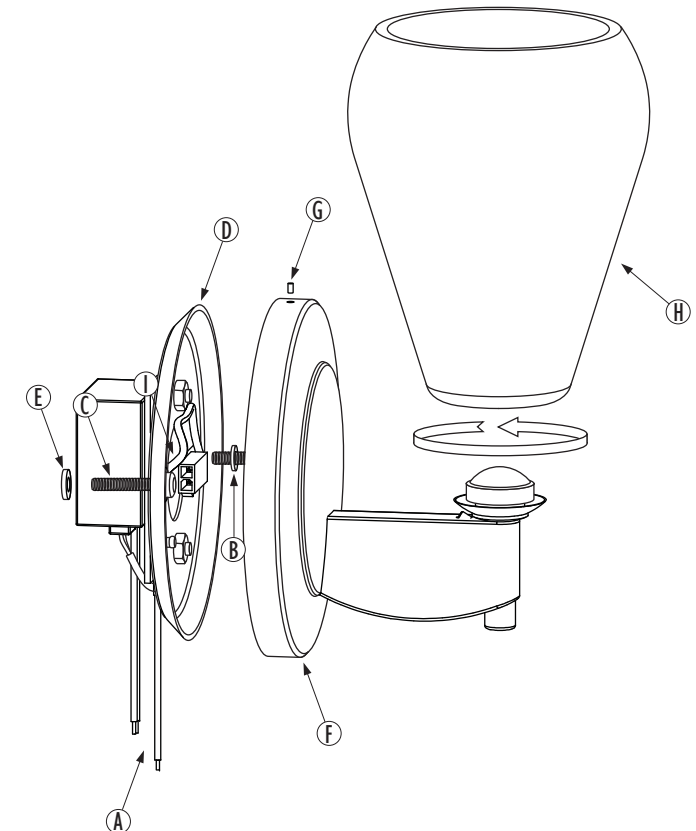

### INSTRUCTIONS FOR USE

- Connect the two wires from the transformer (A) to the power cables in the wall. Then slide the notched plastic washer (B) through the mounting screw (C). Insert the screw (C) into the mounting plate (D) and slide the plastic washer (E) onto the end of the screw. Align the screws (C) with the J-box and tighten until firmly connected.

- Connect quick connect (I) then place the canopy cover (F) over the mounting plate (D) and secure it with the allen screw (G) located on the side of the base.

- Remove the glass shade (H) from the fixture by turning the glass counter-clockwise.

### NOTE

Zara glass should not be removed.