

DIAMOND SCONCES

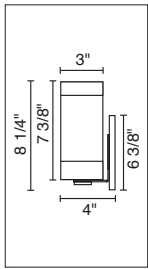

SILVA SCONCE
101 711(bz,ch,mc)
101 712(bz,ch,mc)
101 713(bz,ch,mc)
101 714(bz,ch,mc)
101 715(bz,ch,mc)
101 716(bz,ch,mc)

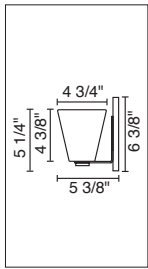

BLING I SCONCE
101 168(bz,ch,mc)
101 176(bz,ch,mc)
101 178(bz,ch,mc)
101 840(bz,ch,mc)
101 841(bz,ch,mc)
101 842(bz,ch,mc)

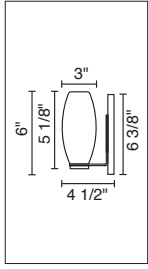

CIRO MINI SCONCE
101 830(bz,ch,mc)
101 831(bz,ch,mc)
101 832(bz,ch,mc)
101 833(bz,ch,mc)

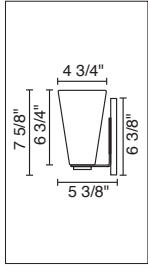

BLING II SCONCE
101 169(bz,ch,mc)
101 174(bz,ch,mc)
101 179(bz,ch,mc)
101 843(bz,ch,mc)
101 844(bz,ch,mc)
101 845(bz,ch,mc)

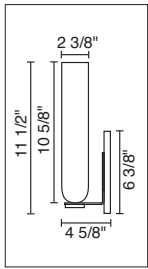

CHIANTI SCONCE
101 820(bz,ch,mc)
101 821(bz,ch,mc)
101 822(bz,ch,mc)
101 823(bz,ch,mc)

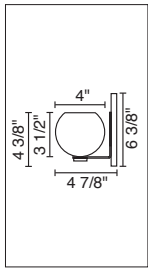

BOBO SCONCE
101 915(bz,ch,mc)
101 917(bz,ch,mc)

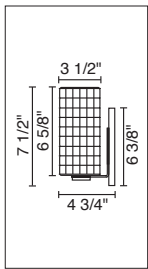

SIERRA SCONCE
101 114bz
101 114ch
101 114mc

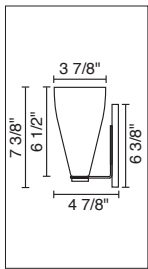

ZARA SCONCE
101 151(bz,ch,mc)
101 152(bz,ch,mc)
101 153(bz,ch,mc)
101 156(bz,ch,mc)
101 157(bz,ch,mc)

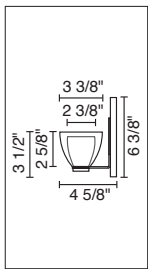

RAINBOW I SCONCE
101 721(bz,ch,mc)
101 722(bz,ch,mc)
101 723(bz,ch,mc)
101 724(bz,ch,mc)
101 913(bz,ch,mc)
101 918(bz,ch,mc)

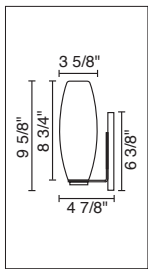

CIRO SCONCE
101 116(bz,ch,mc)
101 119(bz,ch,mc)
101 121(bz,ch,mc)
101 122(bz,ch,mc)
101 124(bz,ch,mc)
101 125(bz,ch,mc)

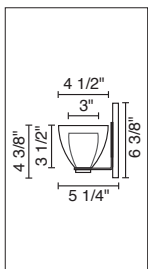

RAINBOW II SCONCE
101 725(bz,ch,mc)
101 726(bz,ch,mc)
101 728(bz,ch,mc)
101 729(bz,ch,mc)
101 816(bz,ch,mc)
101 817(bz,ch,mc)
101 916(bz,ch,mc)
101 919(bz,ch,mc)

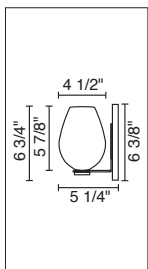

BOLERO SCONCE
101 336(bz,ch,mc)
101 337(bz,ch,mc)
101 338(bz,ch,mc)
101 339(bz,ch,mc)

DIAMOND SCONCES

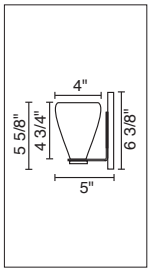

LUCY SCONCE
101 126(bz,ch,mc)
101 127(bz,ch,mc)
101 128(bz,ch,mc)

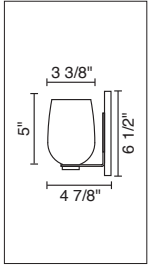

QUEENY I SCONCE
101 321(bz,ch,mc)
101 322(bz,ch,mc)
101 323(bz,ch,mc)
101 324(bz,ch,mc)
101 325(bz,ch,mc)
101 370(bz,ch,mc)
101 371(bz,ch,mc)
101 372(bz,ch,mc)
101 373(bz,ch,mc)

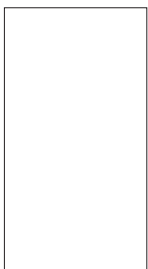
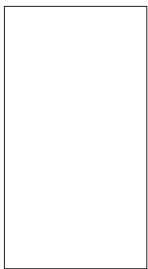
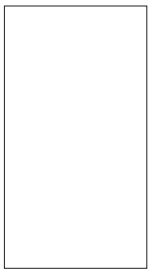
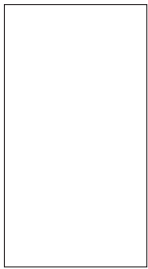

DIAMOND SCONCE

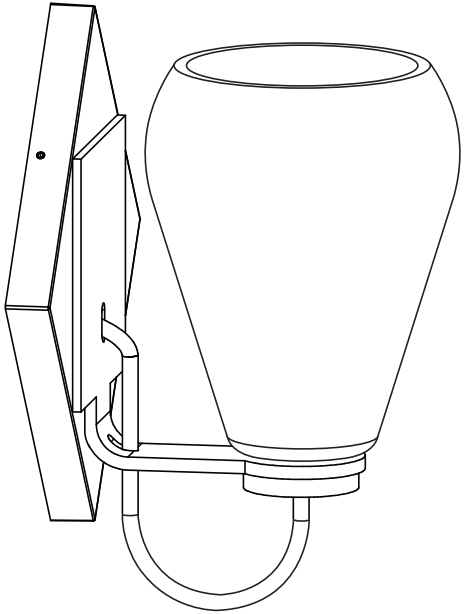

TECHNICAL SPECIFICATIONS

Description: 4" Canopy with J-Box and Glass
Design: Bruck-Team
Lamp: Bi-Pin GY6.35

CONTENTS OF DELIVERY

fixture complete without lamp



IMPORTANT SAFETY INSTRUCTIONS



1. Read all instructions!
2. Turn off power prior to any work on the canopy.
3. THIS PRODUCT MUST BE INSTALLED BY A PERSON FAMILIAR WITH THE CONSTRUCTION AND OPERATION OF THE PRODUCT AND THE HAZARDS INVOLVED, IN ACCORDANCE WITH THE APPLICABLE INSTALLATION CODE.
4. This wall sconce MUST BE HARD WIRED, 120v. For all the wire connections, use Listed Wire Nuts.
5. Only BRUCK Uni-Light fixtures may be used with the wall sconce.
6. Total wattage of the fixture must never exceed the wattage supplied by the low voltage electronic transformer. Please check that the total lamp wattage does not exceed 50W.
7. Secondary connections must be clean and tight to avoid arcing and overheating!
8. Warranty is void in case of unauthorized modifications and/ or improper use.

READ ALL OF THESE INSTRUCTIONS BEFORE INSTALLATION

INSTALLATION INSTRUCTIONS

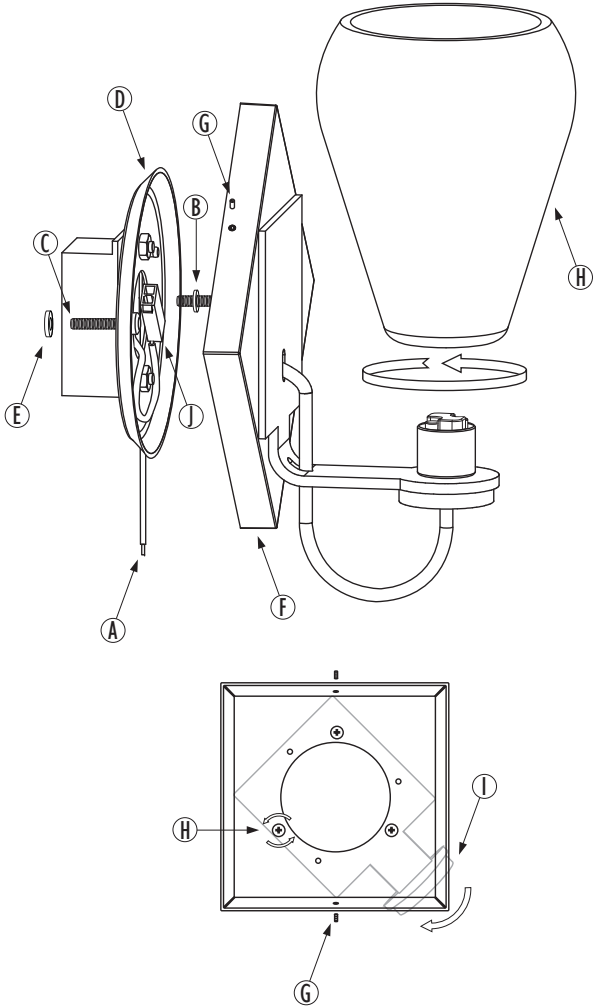

INSTRUCTIONS FOR USE

- Begin by connecting the two wires from the transformer (A) to the power cables in the wall. Then slide the notched plastic washer (B) through the mounting screw (C).
- Insert the screw (C) into the mounting plate (D) and slide the plastic washer (E) onto the end of the screw. Align the screws (C) with the J-box and tighten until firmly connected.
- Connect quick connect (J) then place the canopy cover (F) over the mounting plate (D) and secure it with the allen screw (G) located on the side of the base.

CHANGING DIAMOND CANOPY TO SQUARE

- To rotate stem, unscrew (G) from the canopy cover (F). Unscrew all 3 screws (H) from the back of canopy, rotate stem (I) and align with holes.
- Remove the glass shade (H) from the fixture by turning the glass counter-clockwise. Insert a Bi-Pin lamp into the socket head to complete the installation.

NOTE

Zara glass should not be removed.