



**HFX Multislide
Doors
(Hawaii Only)**
(rev. 6.21.06)

Copyright © 2006 by Pacific Architectural Millwork

All rights reserved. No part of this manual may be reproduced or transmitted in any form or by any means without permission by Pacific Architectural Millwork.

HFX Multislide Doors

Section Contents

Product Overview	2
Sample Configurations.....	4
PXX XXP (Flush): Exterior Elevation.....	5
PXX XXP (Flush): Vertical Section.....	6
PXX XXP (Flush): Plan Section.....	7
PXX XXP (Flush): Head Detail.....	8
PXX XXP (Flush Track Option): Sill Detail.....	9
PXX XXP (Flush): Interlocker Detail.....	10
PXX XXP (Flush): Interlocker Detail at Jamb Pocket.....	11
PXX XXP (Flush): Meeting Panels Detail	12
OXXX (Flush): Exterior Elevation.....	13
OXXX (Flush): Vertical Section.....	14
OXXX (Flush): Plan Section.....	15
OXXX (Flush): Plan Section (Retracted Panels).....	16
OXXX (Flush): Head Detail.....	17
OXXX (Flush Track Option): Sill Detail.....	18
OXXX (Teak Track Option): Sill Detail.....	19
90 Degree Corner: Plan Section	20
90 Degree Corner: Stile Detail	21
XXXO HFX Sliding Window (Optional Screen): Exterior Elevation.....	22
XXXO HFX Sliding Window (Optional Screen): Plan Section.....	23
XXXO HFX Sliding Window (Optional Screen): Plan Section (Retracted Panels).....	24
XXXO HFX Sliding Window (Optional Screen): Head Detail.....	25
XXXO HFX Sliding Window (Optional Screen): Sill Detail	26

Product Overview



Introduction

In the unique Hawaiian market, people desire wide-open expanses, with little or no barrier between their interior and exterior living spaces. For this environment, PAM has developed the Hawaiian Effects (HFX) multislide door.

Our all-wood HFX doors use flush-profile locks and edge pulls, which allow the panels to stack and glide quietly along their tracks and disappear completely into the jamb pocket. These products are not suitable for environments where weather-resistance is a factor, but in the tropical locale of Hawaii, the climate is so ideal that window and door products remain open most of the time.

Many of these custom homes incorporate doors in a 90 degree corner application, with 20-30 ft. of pocketing doors on either side. This type of architecture is unique to Hawaii and gives the homeowner the full benefits of living in the tropics, where the emphasis is on natural materials and the "pavilion" lifestyle that is found throughout the South Pacific.

Hardware Options

The HFX multislide door comes with hardware in your choice of finishes:

- Stainless Steel
- Oil-Rubbed Bronze

Lock cylinders are optional.

Glazing Options

Standard glazing for the HFX door uses 1/4" laminated glass. Custom glazing and tinted glass are also available.

We offer two different edge details:

- Contemporary
- Traditional

See the General Info section for more details.

Wood Species

Our standard wood species are the following:

- Pine
- Vertical Grain Douglas Fir
- Mahogany

Alternative and exotic wood species are also available.

Other Options

Custom options such as wood screens and louvers are available for the HFX system, which can also be built as a sliding window. Choose from a flush stainless steel track or teak track.

NOTE: Flush track is not warranted against air, water, or dust infiltration.

Contact Pacific Architectural Millwork for additional options and customization.

Product Parameters:

Max Height:	9'
Min/Max Panel Width:	28" min / 6' max
Max. Glass Size:	55 sq. ft. or 400 lbs. OA
Max Opening:	30'
Panel Thickness:	1 3/4"
Screen Thickness:	1 3/4"
Min Jamb Depth:	Varies, depending on configuration & number of panels

Hardware Images:



Sample Configurations

You can order your HFX door in either fixed, pocket, or corner configurations. The following drawings show some sample configurations.

(Key: P=Pocket, X=Moving Panel, O=Fixed Panel)

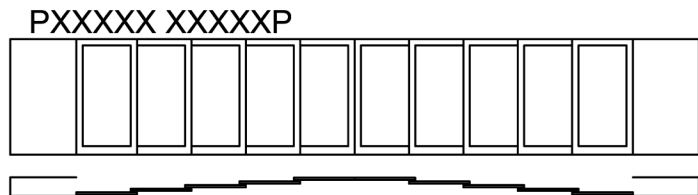
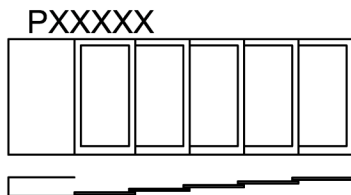
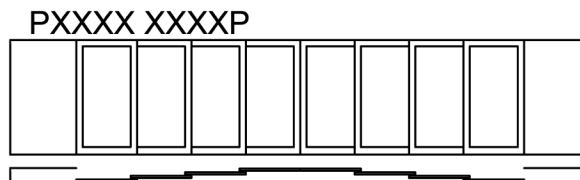
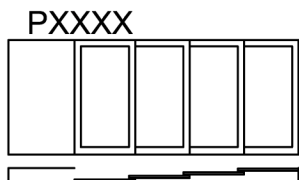
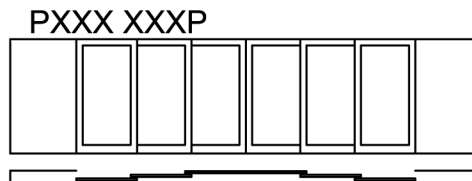
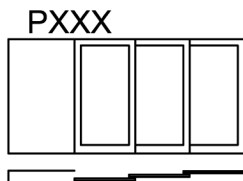
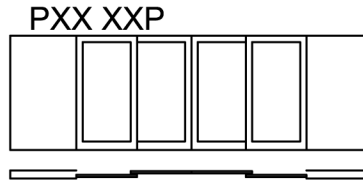
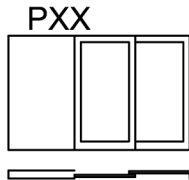
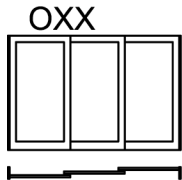
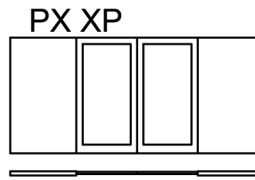
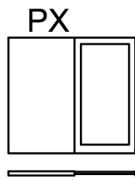
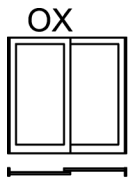

PXX XXP (Flush): Exterior Elevation

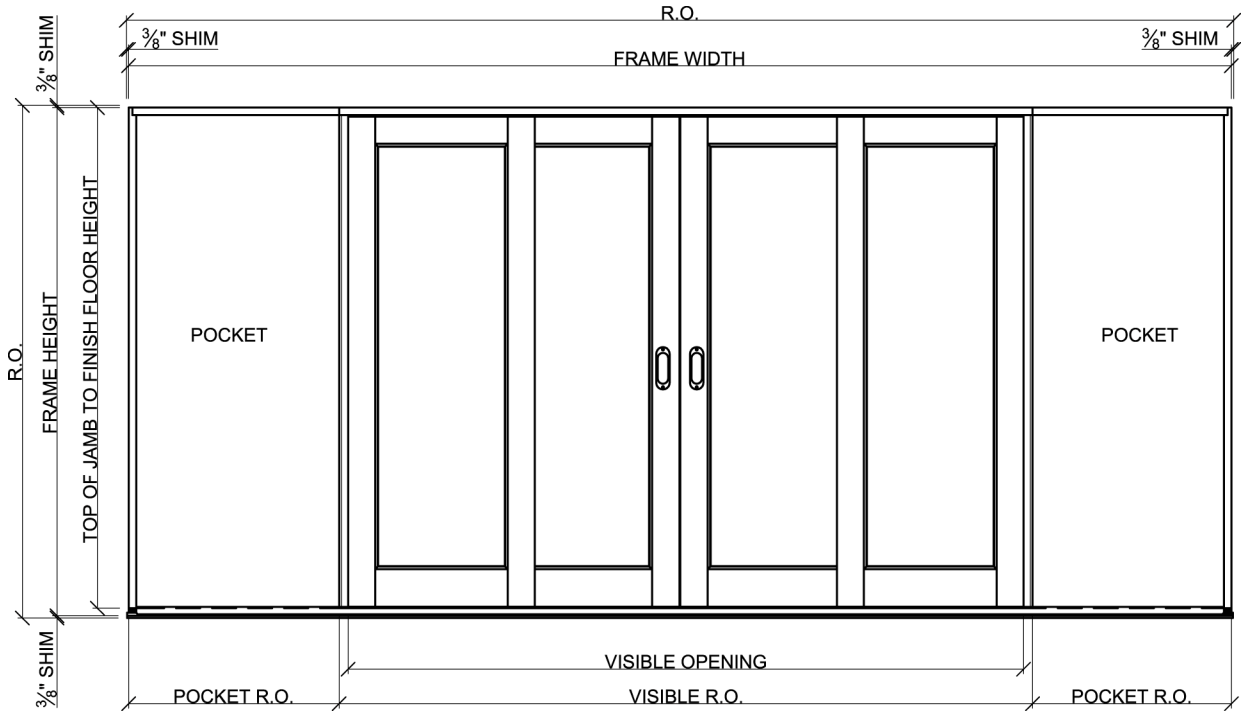

PXX XXP (Flush): Vertical Section

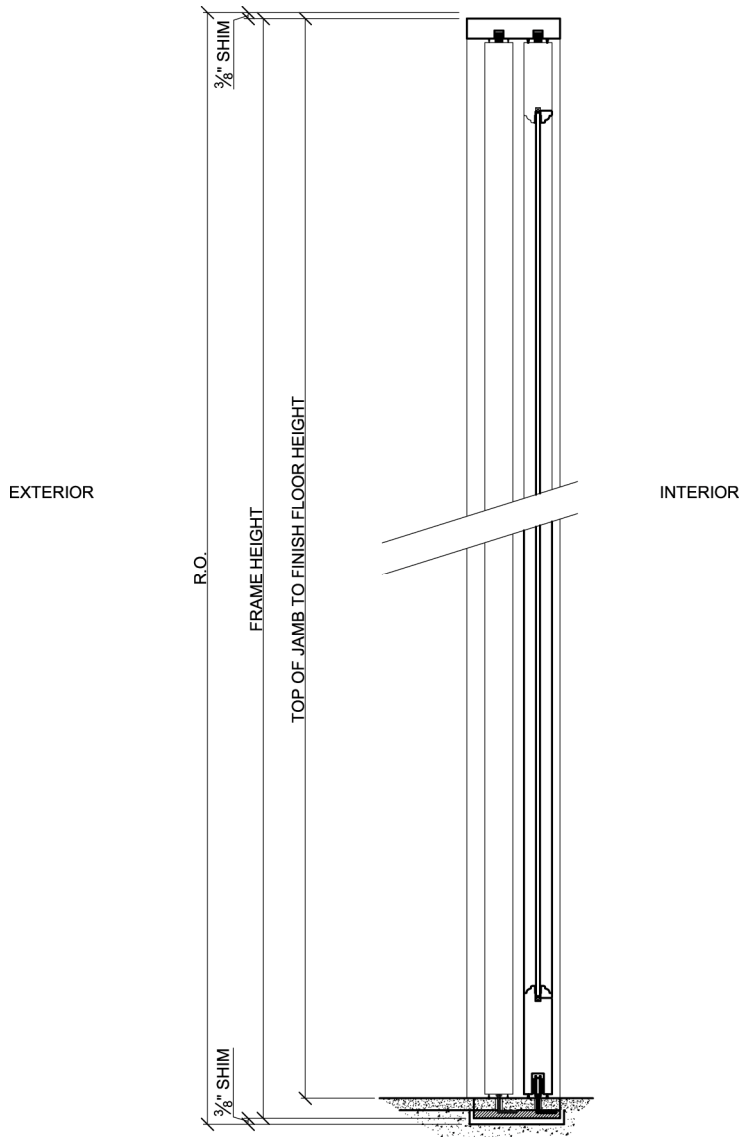

PXX XXP (Flush): Plan Section

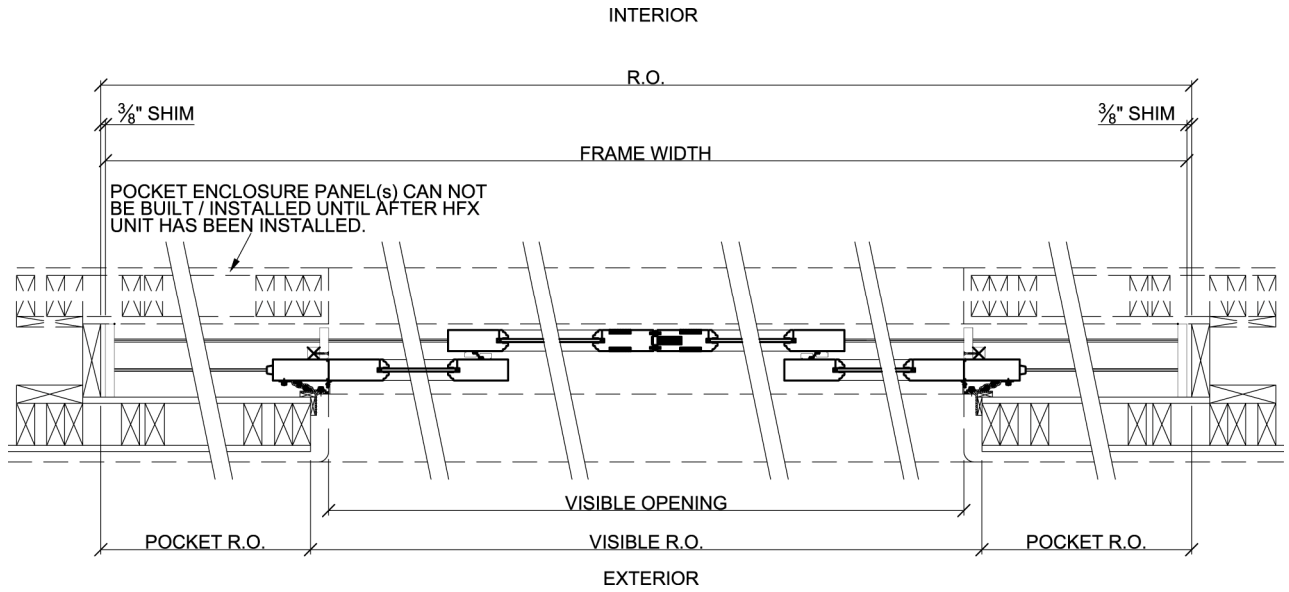

PXX XXP (Flush): Head Detail

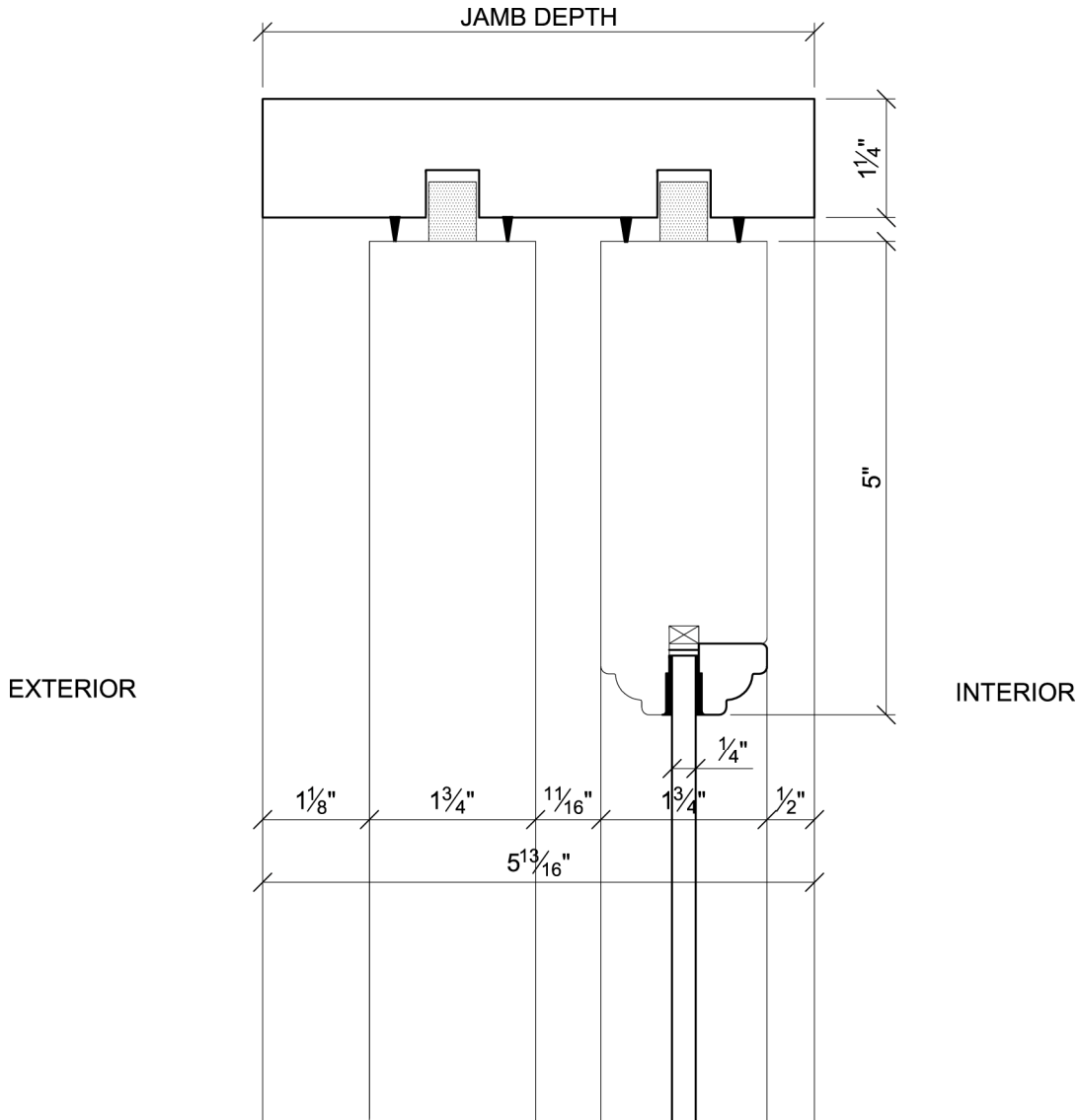

PXX XXP (Flush Track Option): Sill Detail

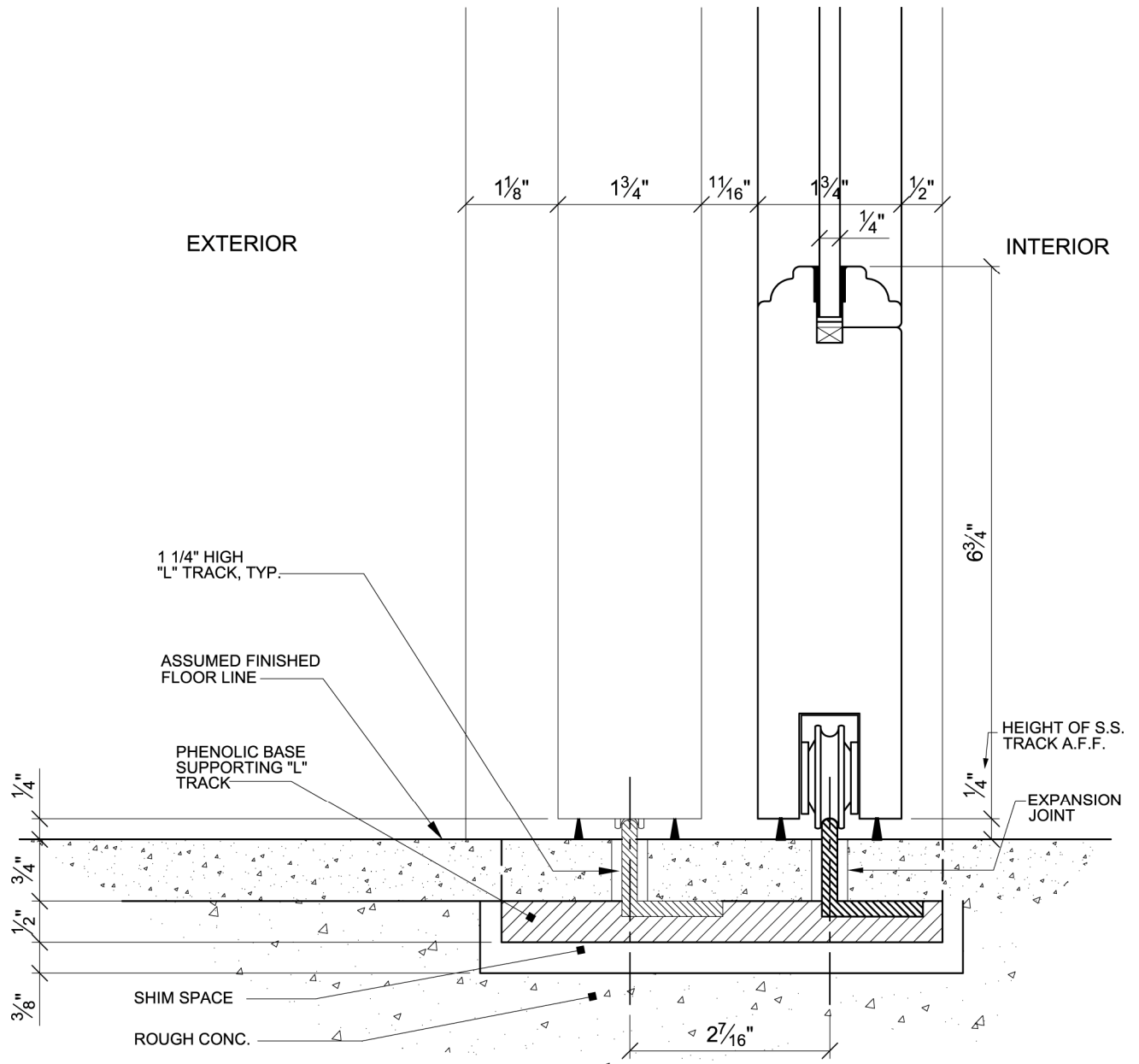

PXX XXP (Flush): Interlocker Detail

INTERIOR

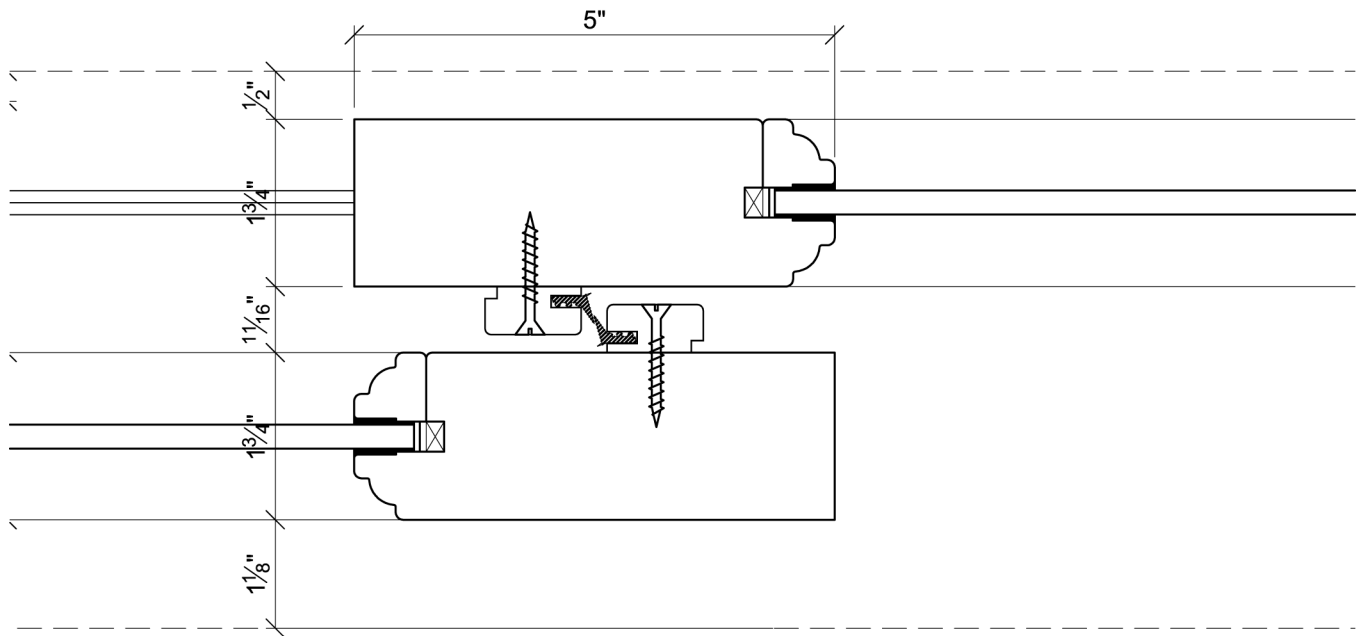

EXTERIOR

PXX XXP (Flush): Interlocker Detail at Jamb Pocket

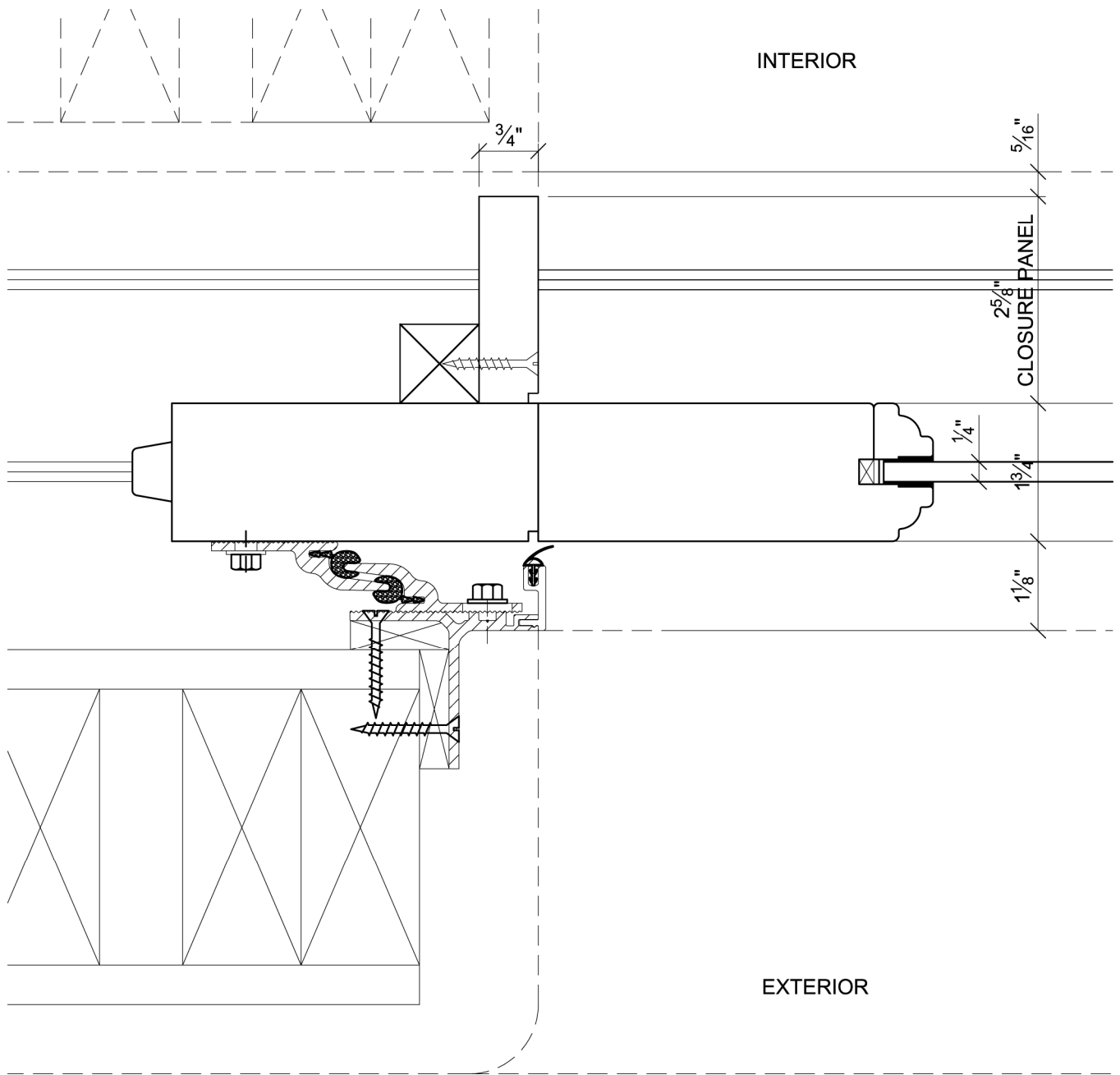

PXX XXP (Flush): Meeting Panels Detail

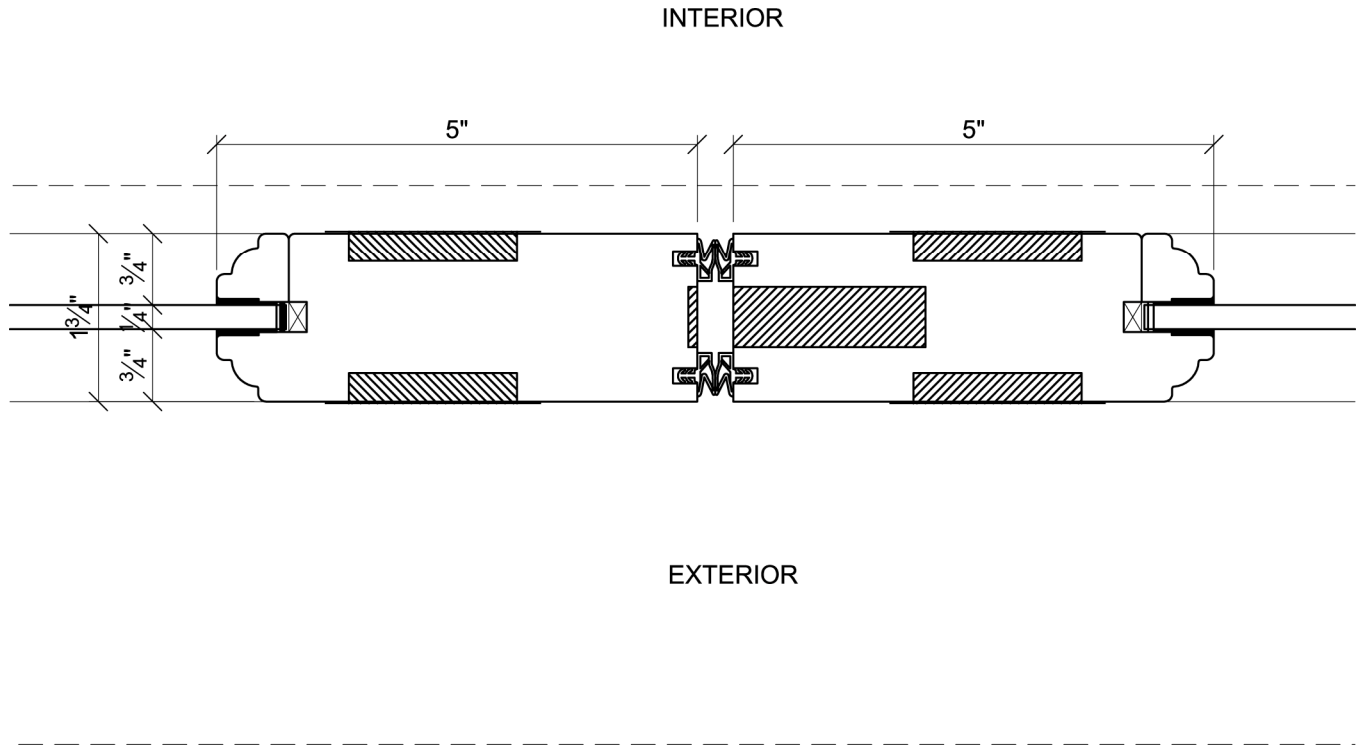

OXXX (Flush): Exterior Elevation

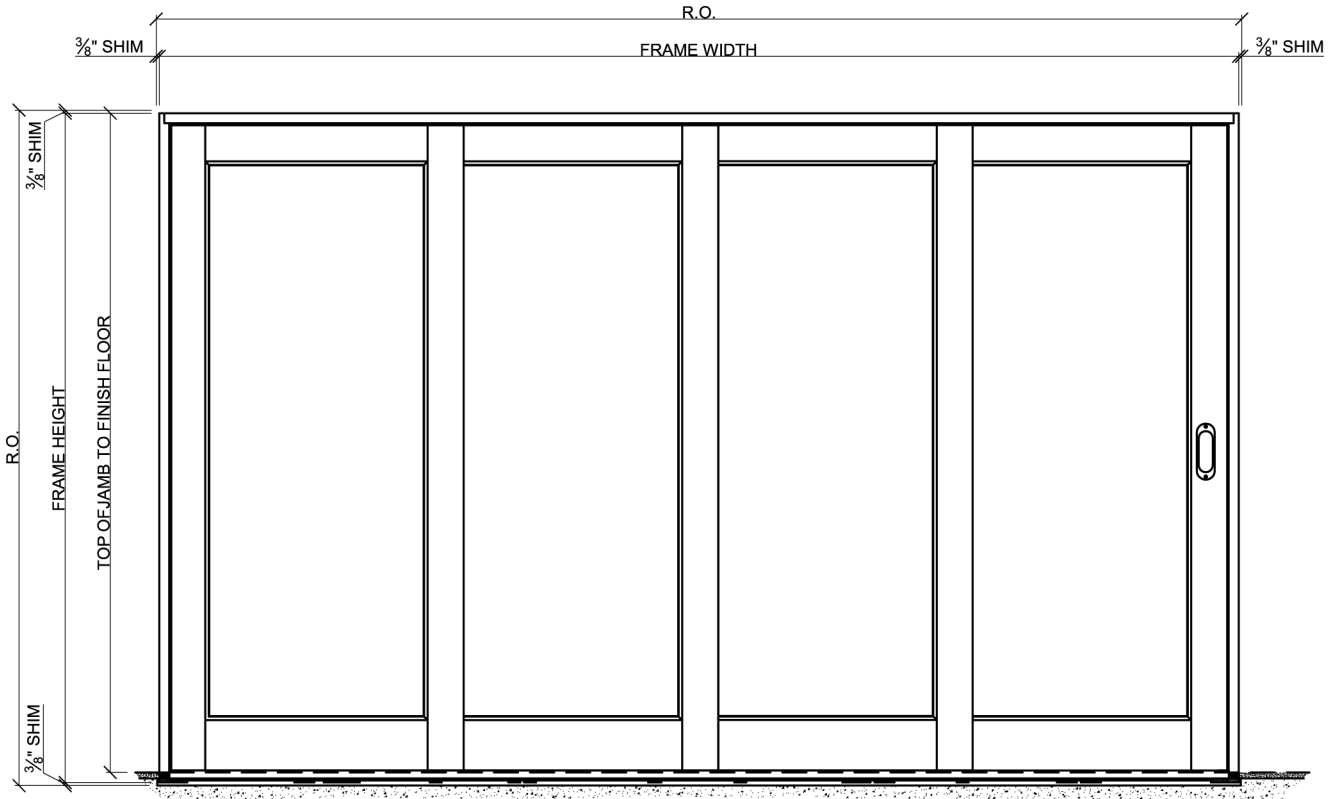

OXXX (Flush): Vertical Section

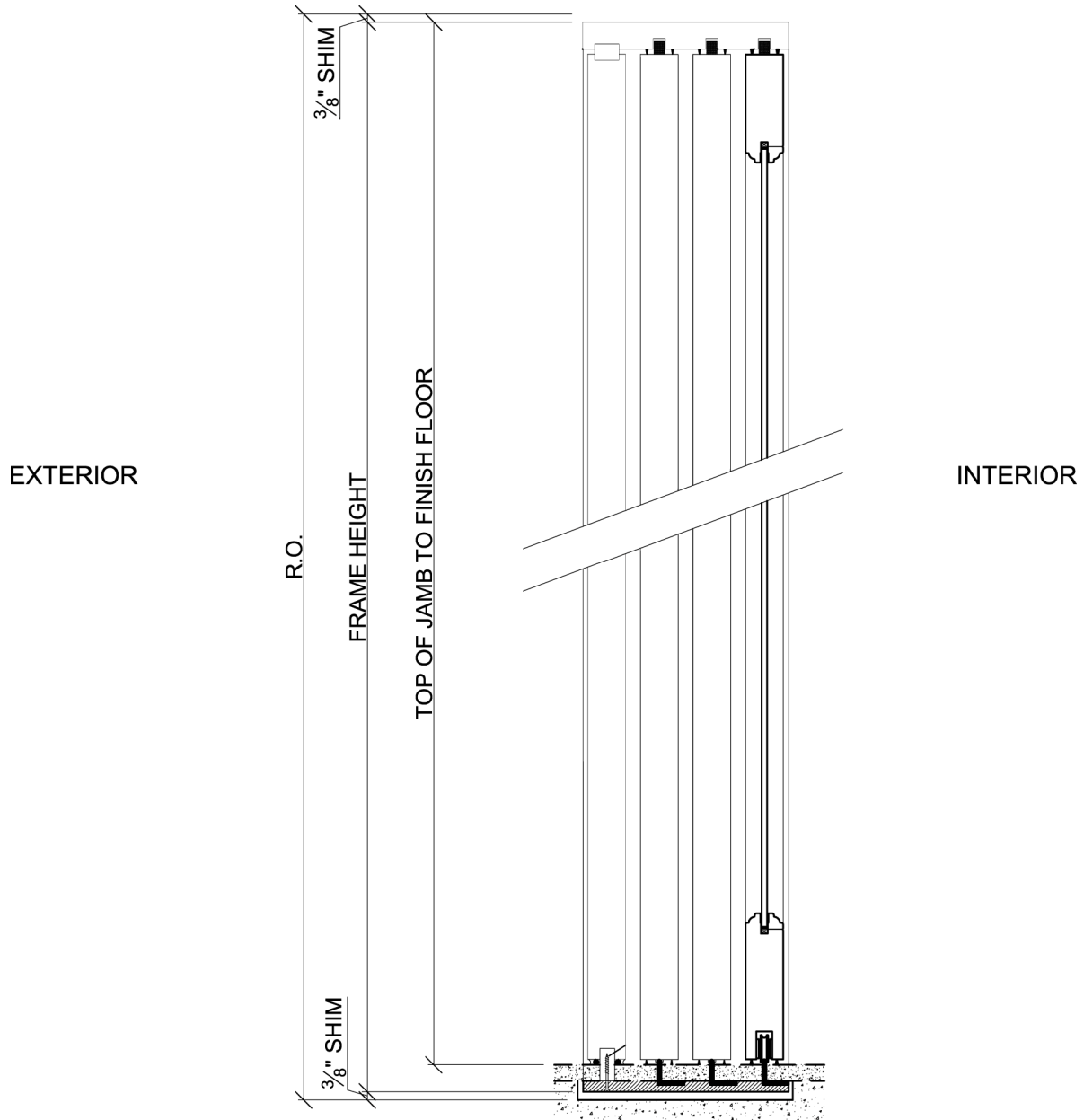

OXXX (Flush): Plan Section

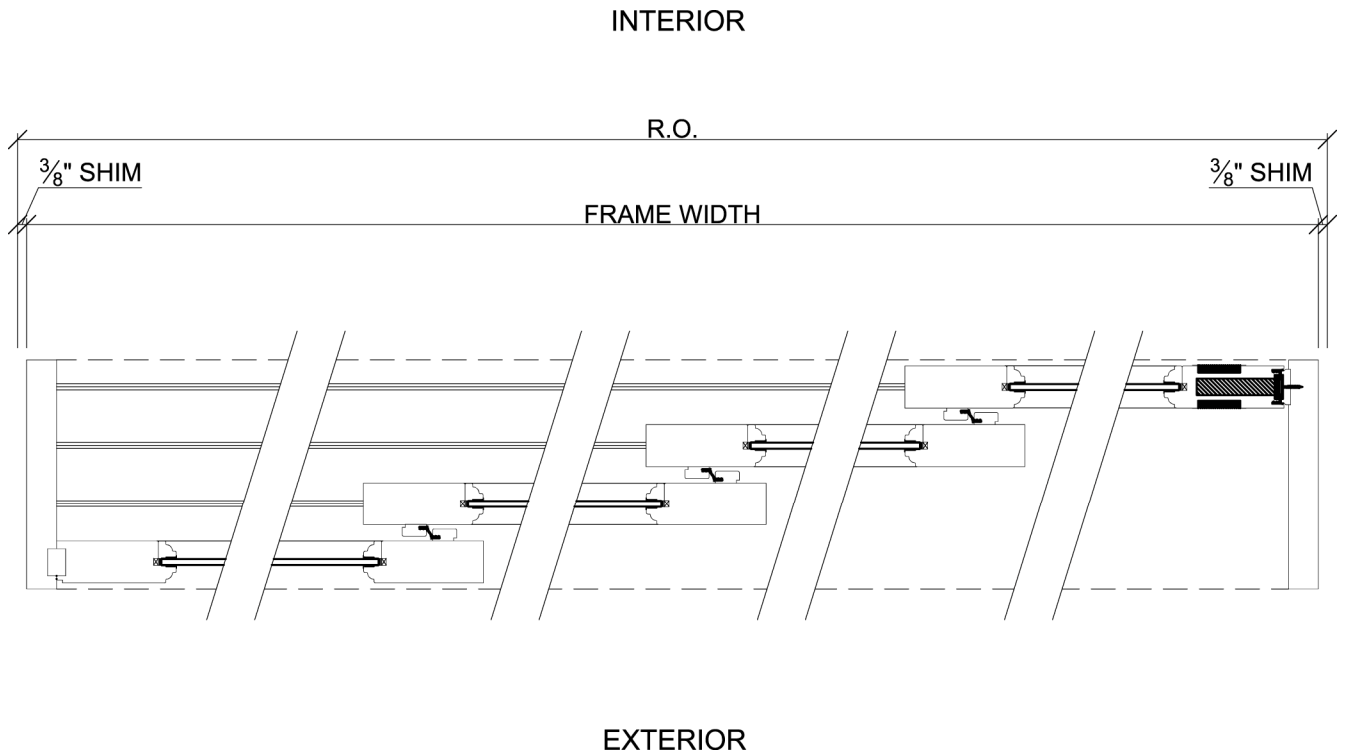

OXXX (Flush): Plan Section (Retracted Panels)

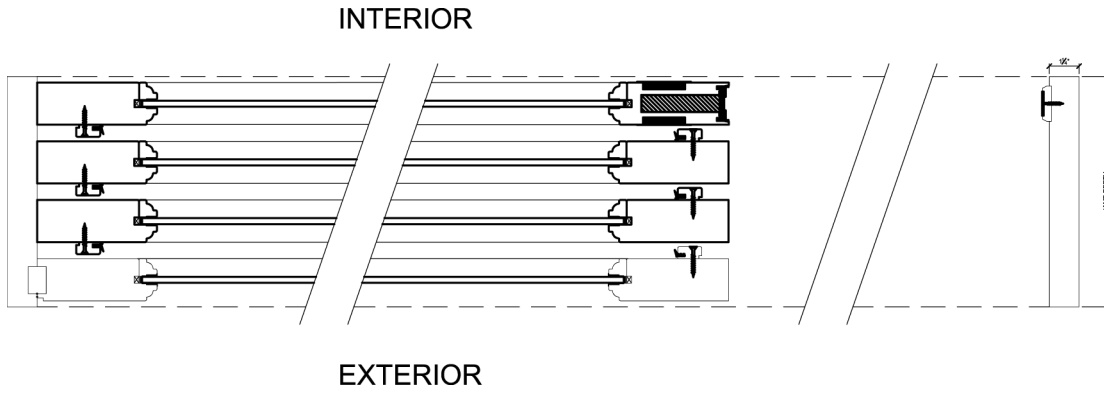

OXXX (Flush): Head Detail

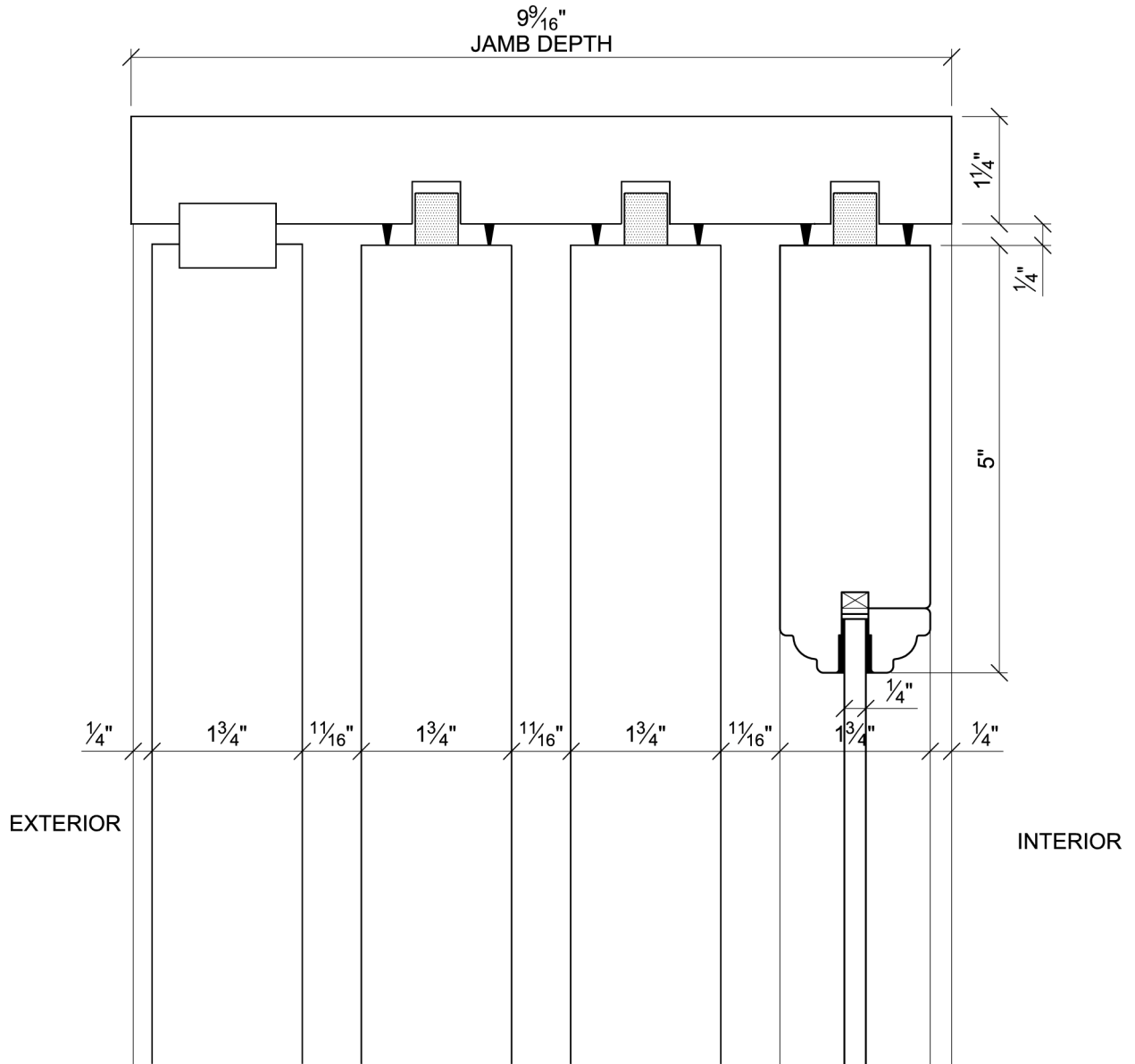

OXXX (Flush Track Option): Sill Detail

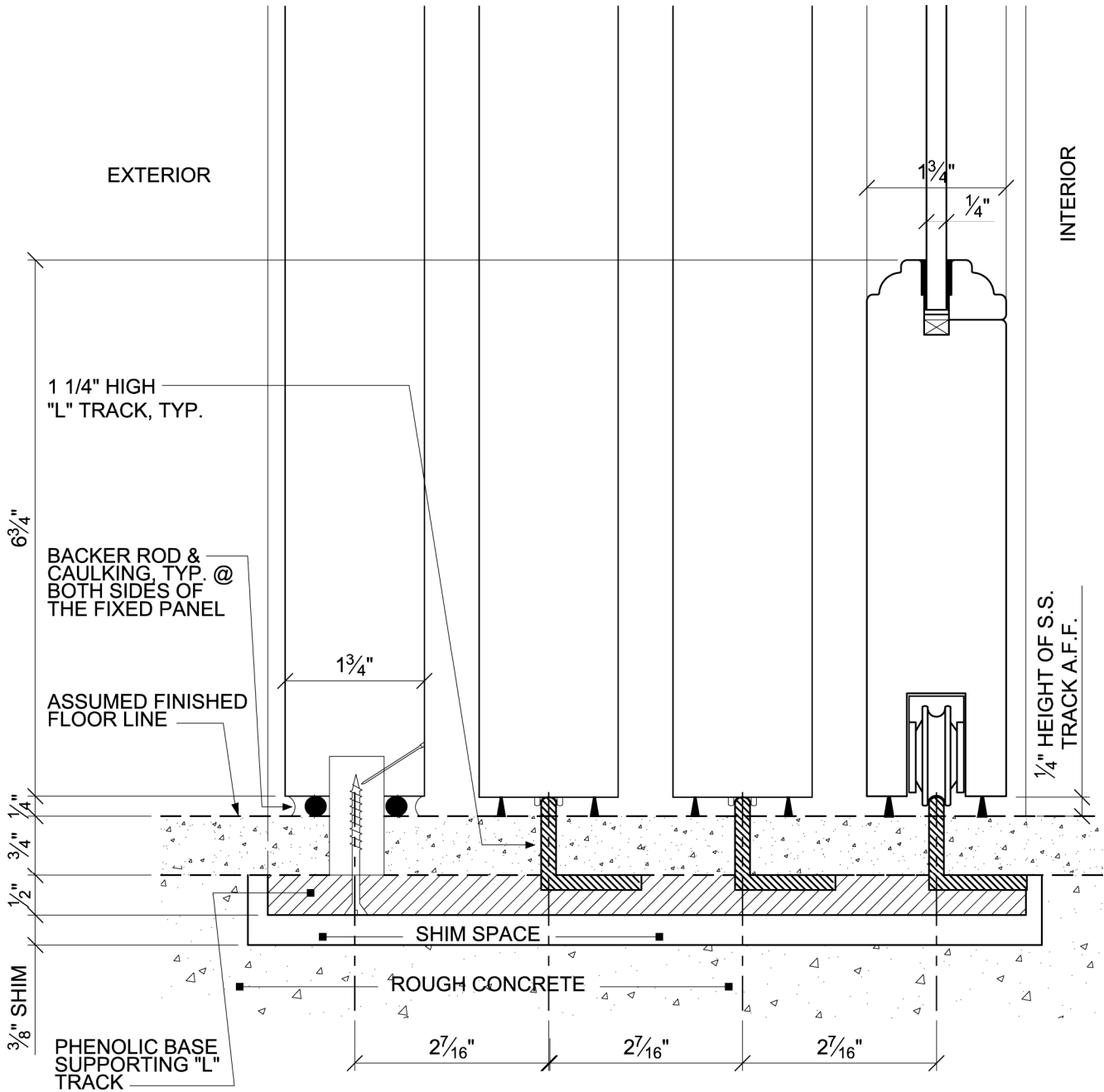

OXXX (Teak Track Option): Sill Detail

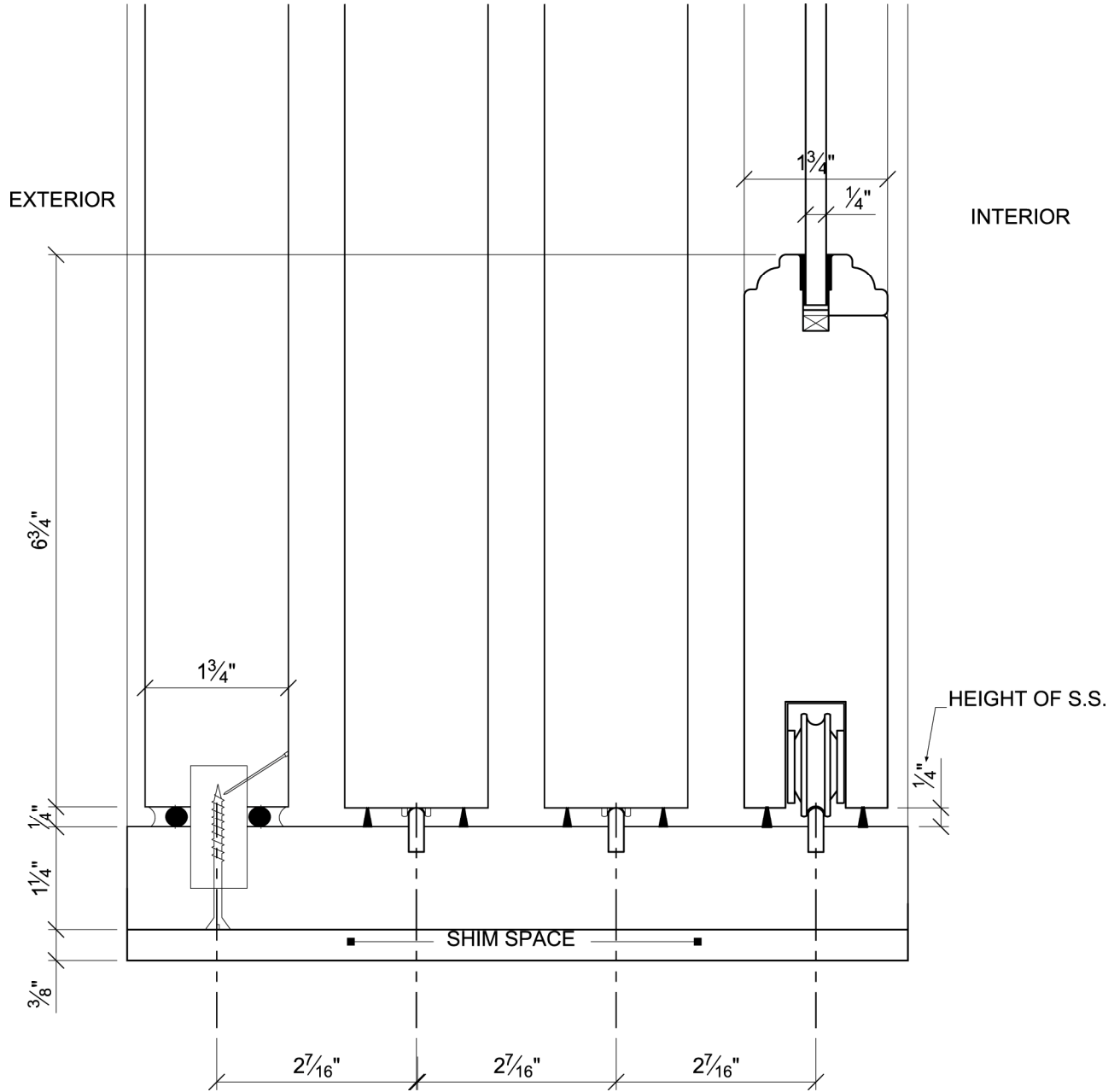

90 Degree Corner: Plan Section

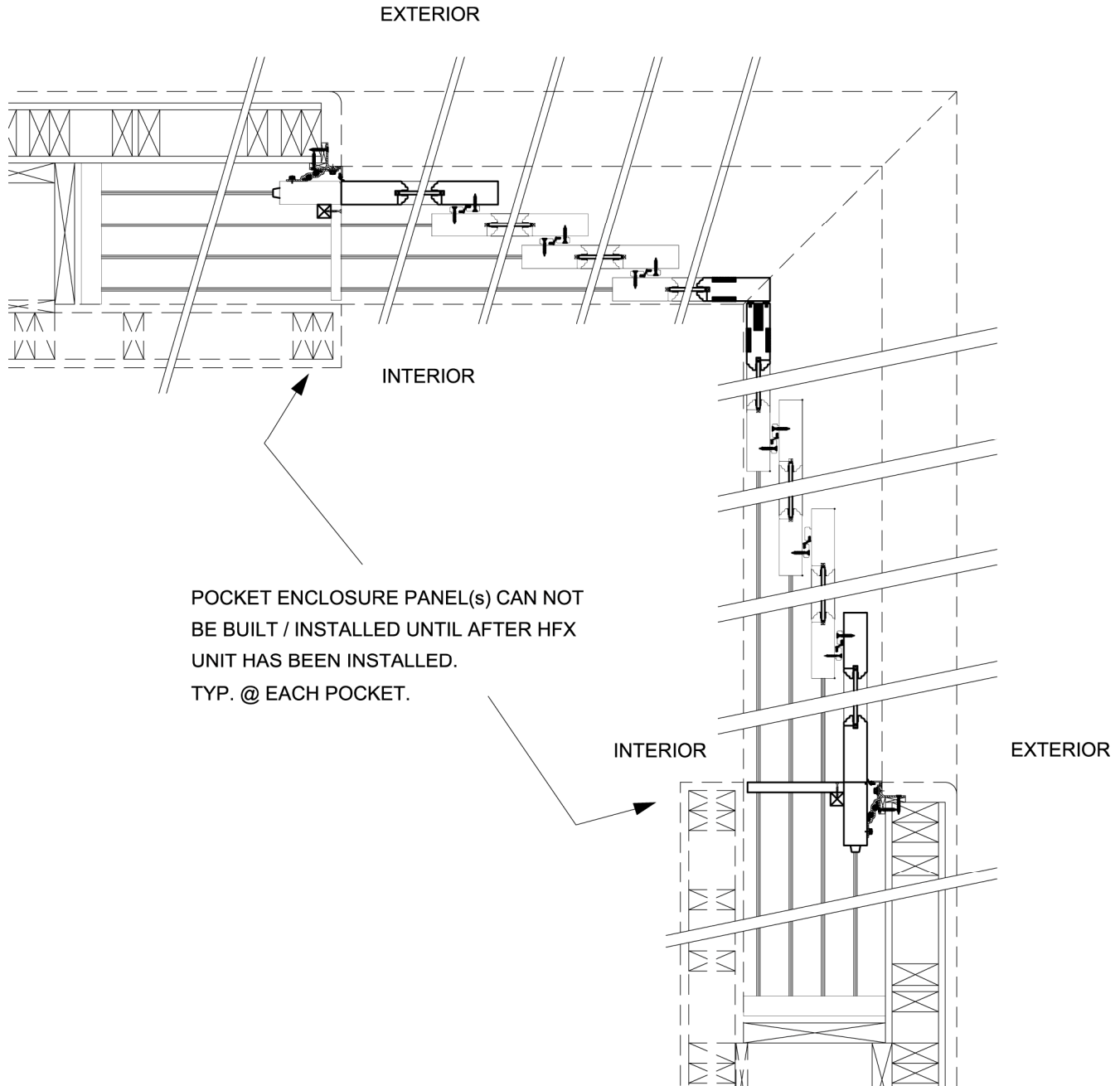

90 Degree Corner: Stile Detail

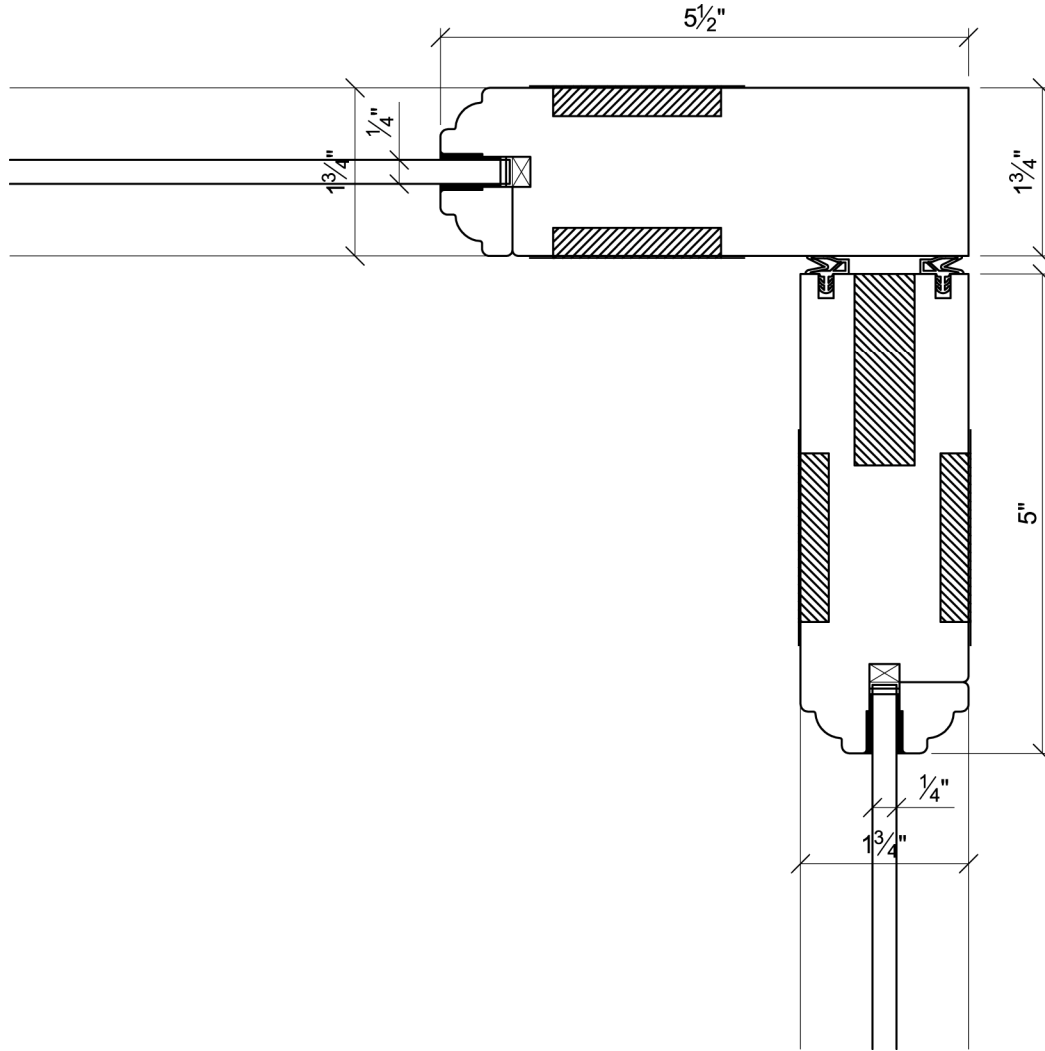

XXXO HFX Sliding Window (Optional Screen): Exterior Elevation

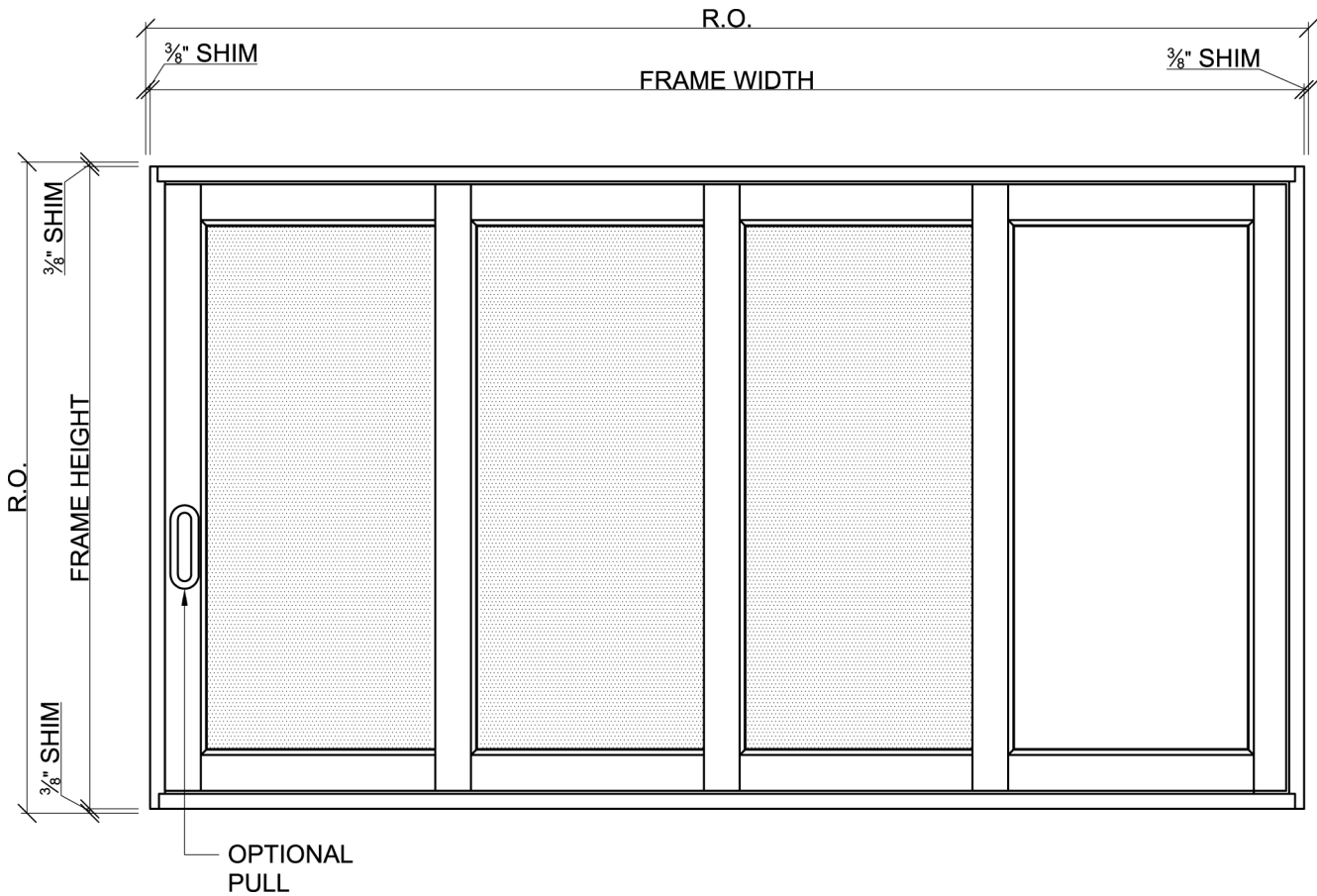

XXXO HFX Sliding Window (Optional Screen): Plan Section

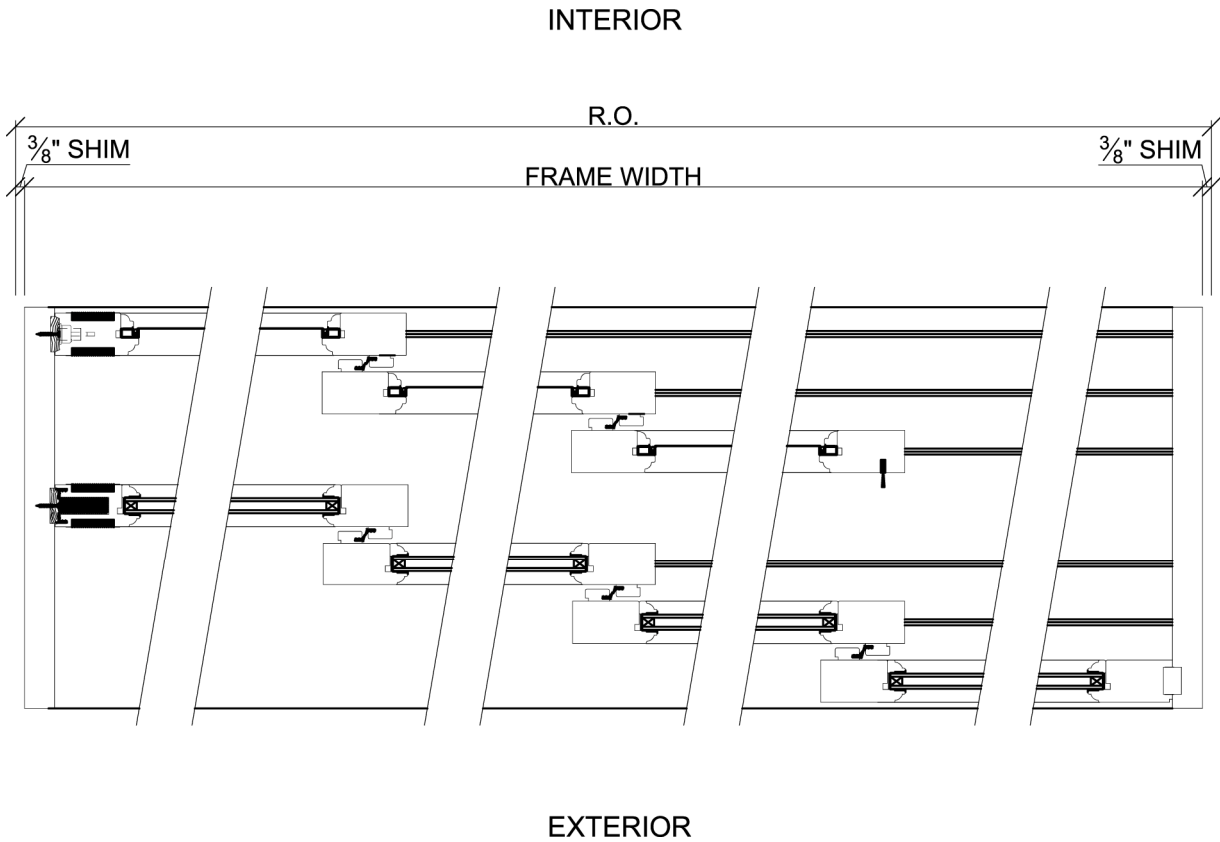

XXXO HFX Sliding Window (Optional Screen): Plan Section (Retracted Panels)

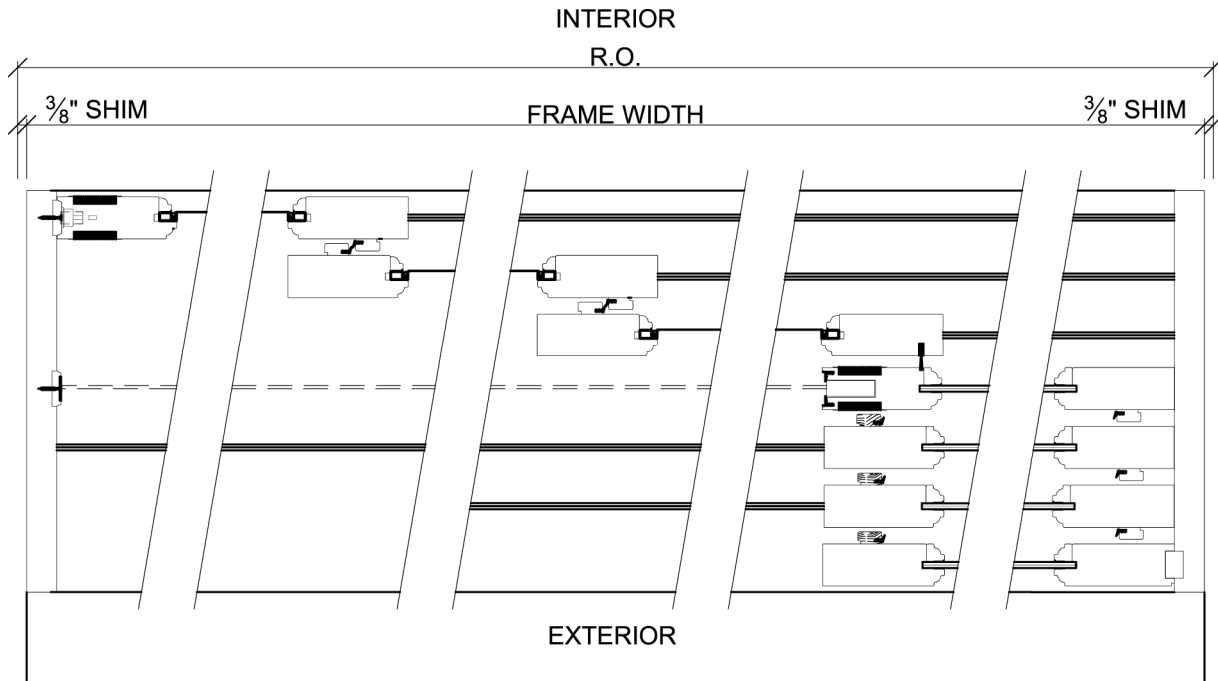

XXXO HFX Sliding Window (Optional Screen): Head Detail

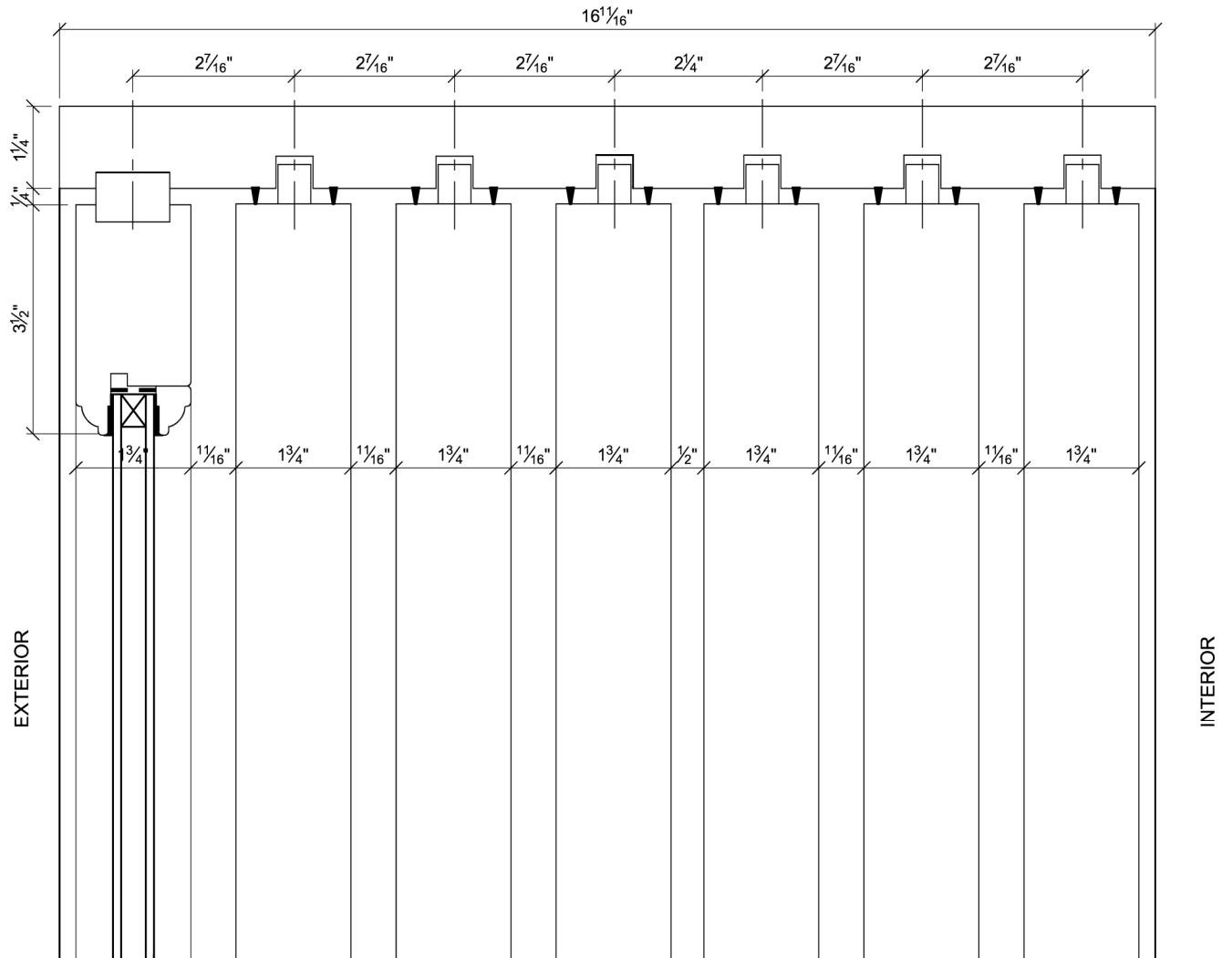

XXXO HFX Sliding Window (Optional Screen): Sill Detail

