



**Wood**  
**Lift-and-Slide Doors**  
(rev. 6.21.06)

Copyright © 2006 by Pacific Architectural Millwork

All rights reserved. No part of this manual may be reproduced or transmitted in any form or by any means without permission by Pacific Architectural Millwork.



# Wood Lift-and-Slide Doors

## Section Contents

Product Overview .....	2
Sample Configurations.....	4
PXX XXP (Flush): Exterior Elevation.....	5
PXX XXP (Flush): Vertical Section.....	6
PXX XXP (Flush): Plan Section.....	7
PXX XXP (Flush): Pocket Detail .....	8
PXX XXP (Flush): Head Detail.....	9
PXX XXP (Flush Track Option): Sill Detail.....	10
PXX XXP (Teak Track Option): Sill Detail.....	11
PXX XXP (Flush): Meeting Stiles Detail.....	12
PXX XXP (Flush): Interlocker Detail.....	13
PXX XXP (Flush): Interlocker Detail at Jamb Pocket.....	14
OXXO (Flush): Exterior Elevation .....	15
OXXO (Flush): Vert. Section @ Fixed Panel.....	16
OXXO (Flush): Vert. Section @ Operable Panel .....	17
OXXO (Flush): Plan Section.....	18
OXXO (Flush): Head Detail @ Fixed Panel .....	19
OXXO (Flush): Head Detail @ Operable Panel.....	20
OXXO (Flush Track Option): Sill Detail @ Fixed Panel .....	21
OXXO (Flush Track Option): Sill Detail @ Operable Panel.....	22
OXXO (Flush): Jamb Detail.....	23

## Wood Lift-and-Slide Doors

(rev. 6.21.06)



# Product Overview



### Introduction

Lift-and-Slide doors by Pacific Architectural Millwork are extraordinary doorways to panoramic views. This is no ordinary sliding door - our Lift-and-Slide doors create virtual moving walls of wood-framed glass panels that stack or disappear into a pocket, opening up living spaces to the outdoors.

Precision-crafted, our Lift-and-Slide doors are made from quality materials with custom features to complement your project's design.

### Hardware Options

The wood Lift-and-Slide door comes with hardware in your choice of finishes:

- Polished Brass
- Matte Black
- Oil-Rubbed Brass
- White
- Brushed Chrome
- Satin Nickel
- Antique Brass
- Polished Chrome

Key cylinders optional. Custom hardware and handles are also available.

### Glazing Options

Standard glazing for the Lift-and-Slide door uses 1" overall tempered insulated glass. Custom glazing and tinted glass are available.

We offer two different edge details:

- Contemporary
- Traditional

See the General Info section for more details.

### Wood Species

Our standard wood species are the following:

- Pine
- Vertical Grain Douglas Fir
- Mahogany

Alternative and exotic wood species are also available.

### Other Options

The Lift-and-Slide door can be purchased with custom options such as screens, and you can choose from two different track options:

- Flush stainless steel track (not recommended for wood floors)
- Teak track





NOTE: Flush track is not warranted against air, water, or dust infiltration.

Contact Pacific Architectural Millwork for additional options and customization.

**Product Parameters:**

Max Height:	10'
Min/Max Panel Width:	28"
Max Panel Width:	8', depending on height/weight ratio
Max. Glass Size:	55 sq. ft. or 450 lbs., depending on height/weight ratio
Max Opening:	30'
Muntin Width:	1 3/8" std.
Panel Thickness:	2 1/2"
Screen Thickness:	1 3/4"
Stiles/Top Rail Width:	3 5/8"
Bottom Rail Width:	6 3/4"

**Hardware Images:**

			
Tapered Handle (Std.)	Recessed Pull	Square Handle	Removable Handle

# Sample Configurations

You can order your Lift-and-Slide in either fixed, pocket, or corner configurations. The following drawings show some sample configurations.

(Key: P=Pocket, X=Moving Panel, O=Fixed Panel)

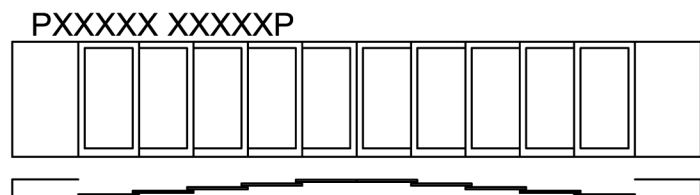
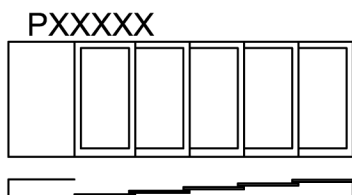
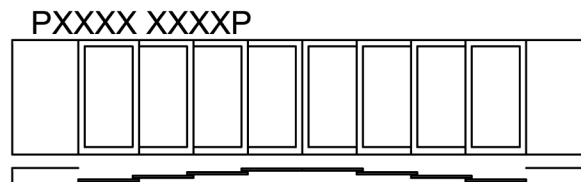
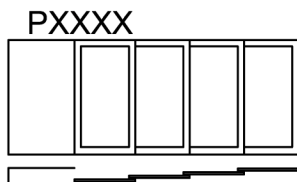
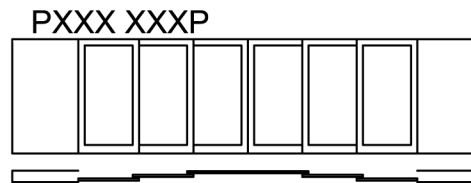
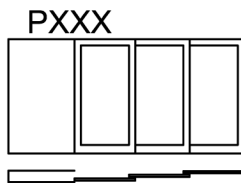
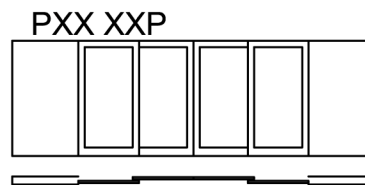
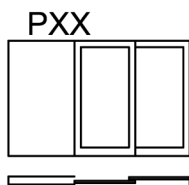
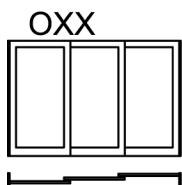
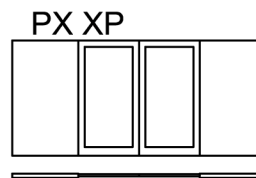
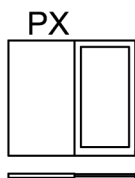
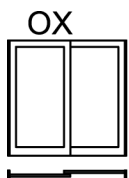

# Wood Lift-and-Slide Doors

(rev. 6.21.06)



## PXX XXP (Flush): Exterior Elevation

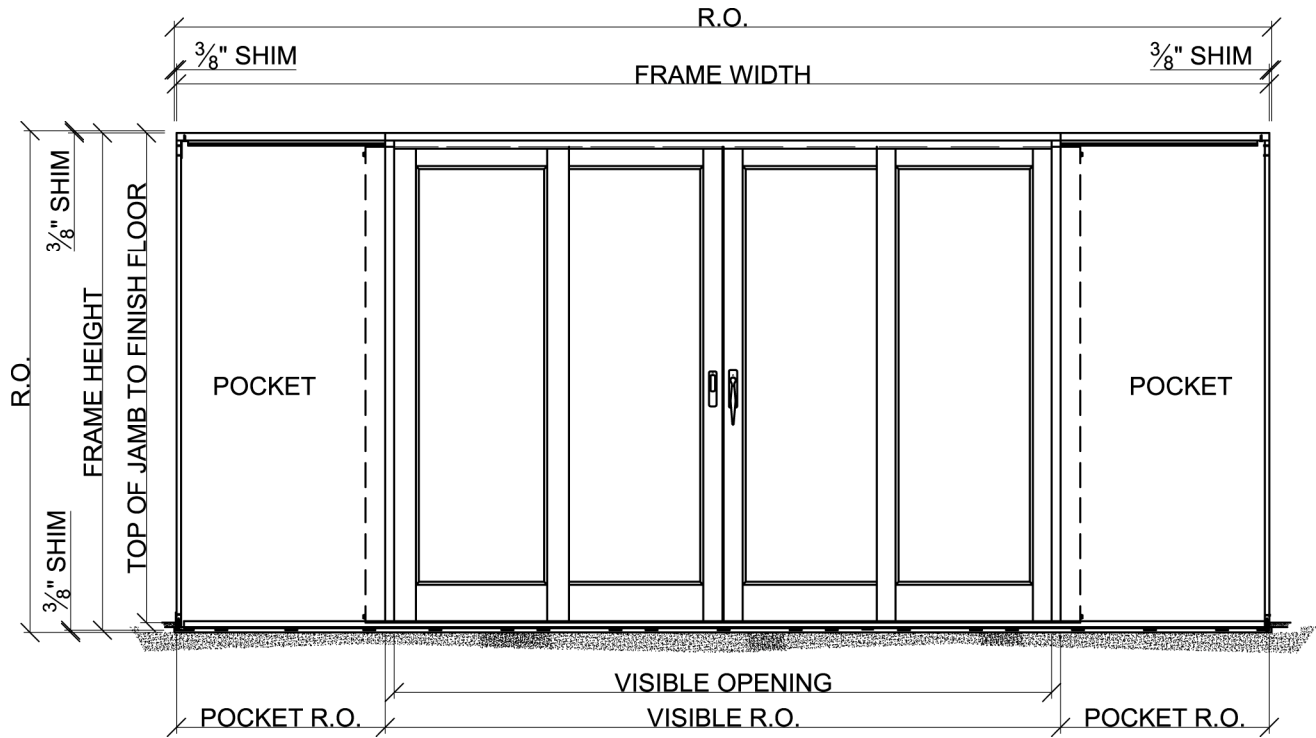

# PXX XXP (Flush): Vertical Section

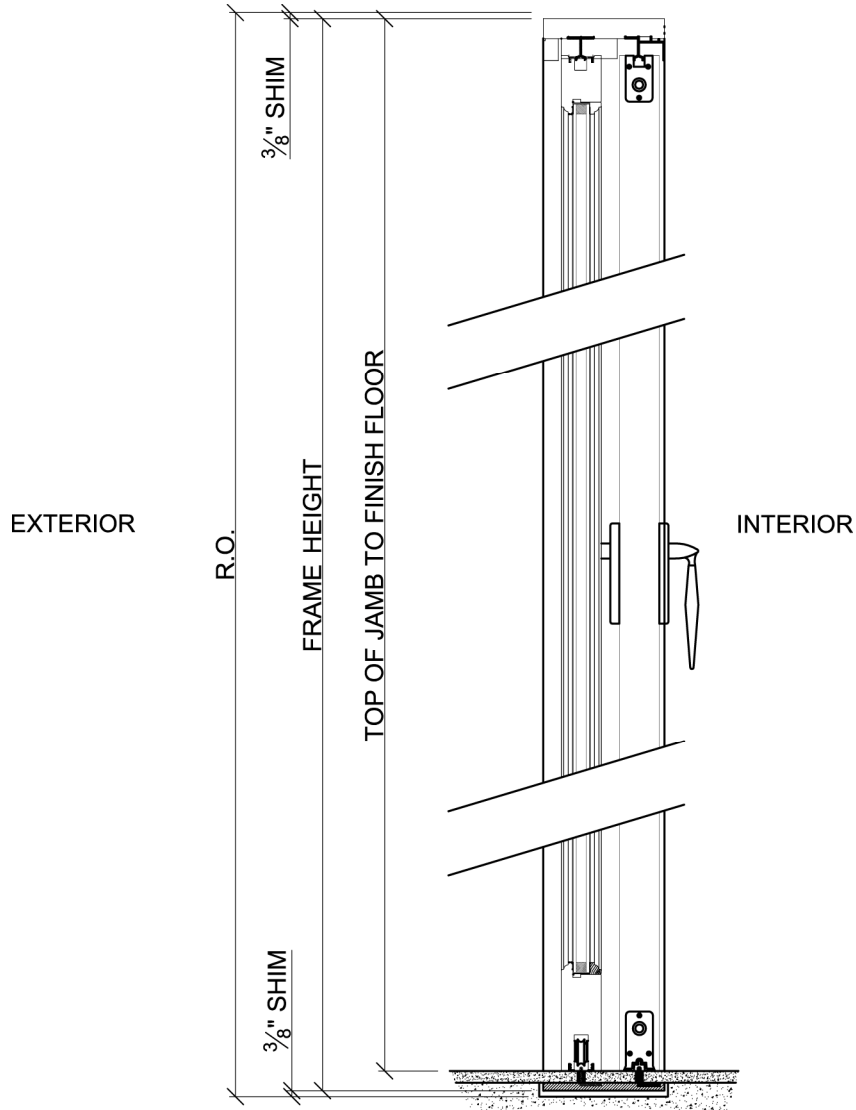



# Wood Lift-and-Slide Doors

(rev. 6.21.06)

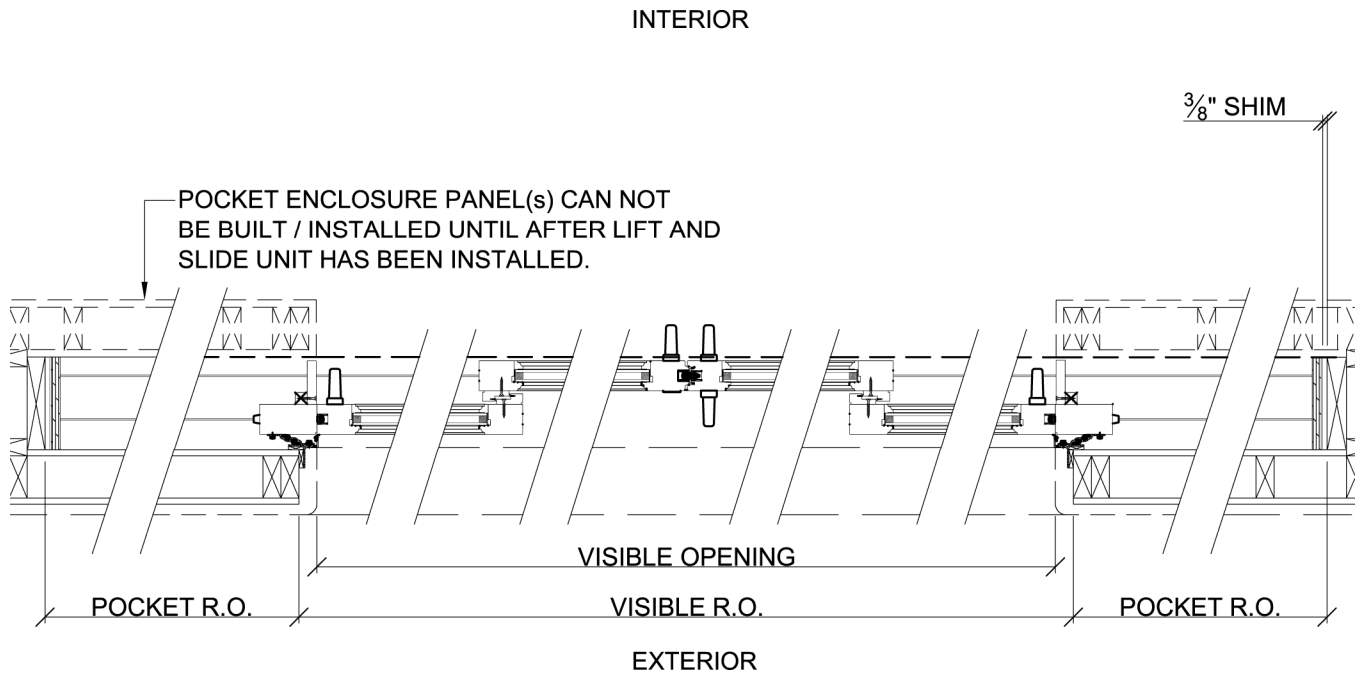

# PXX XXP (Flush): Pocket Detail

POCKET ENCLOSURE PANEL(S) CAN NOT BE BUILT / INSTALLED UNTIL AFTER LIFT AND SLIDE UNIT HAS BEEN INSTALLED.

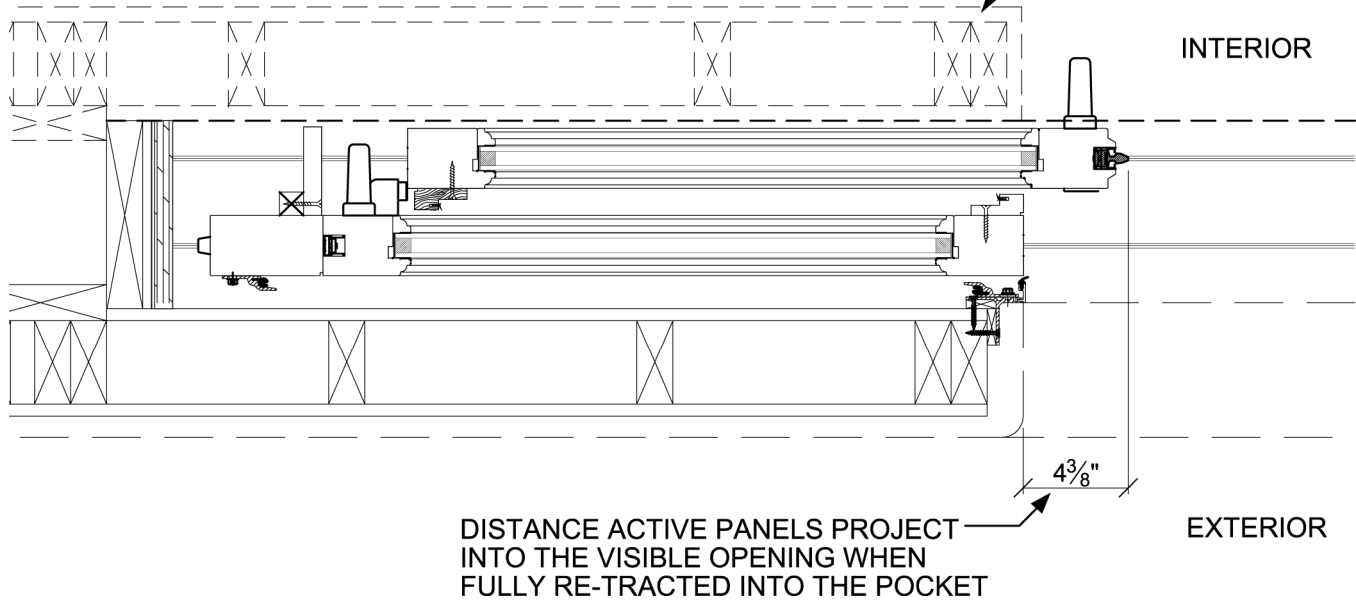

# Wood Lift-and-Slide Doors

(rev. 6.21.06)



## PXX XXP (Flush): Head Detail

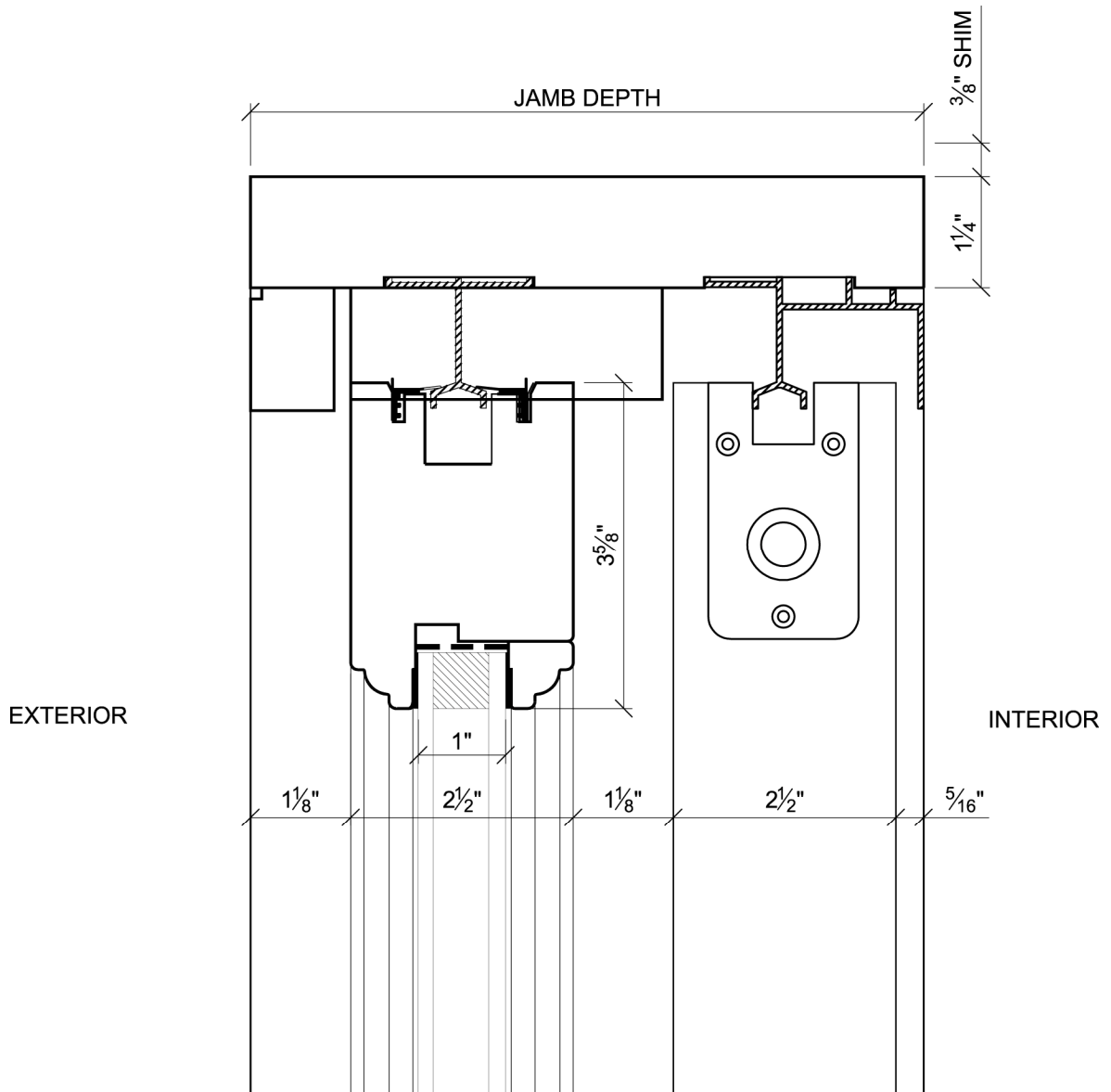

# PXX XYP (Flush Track Option): Sill Detail

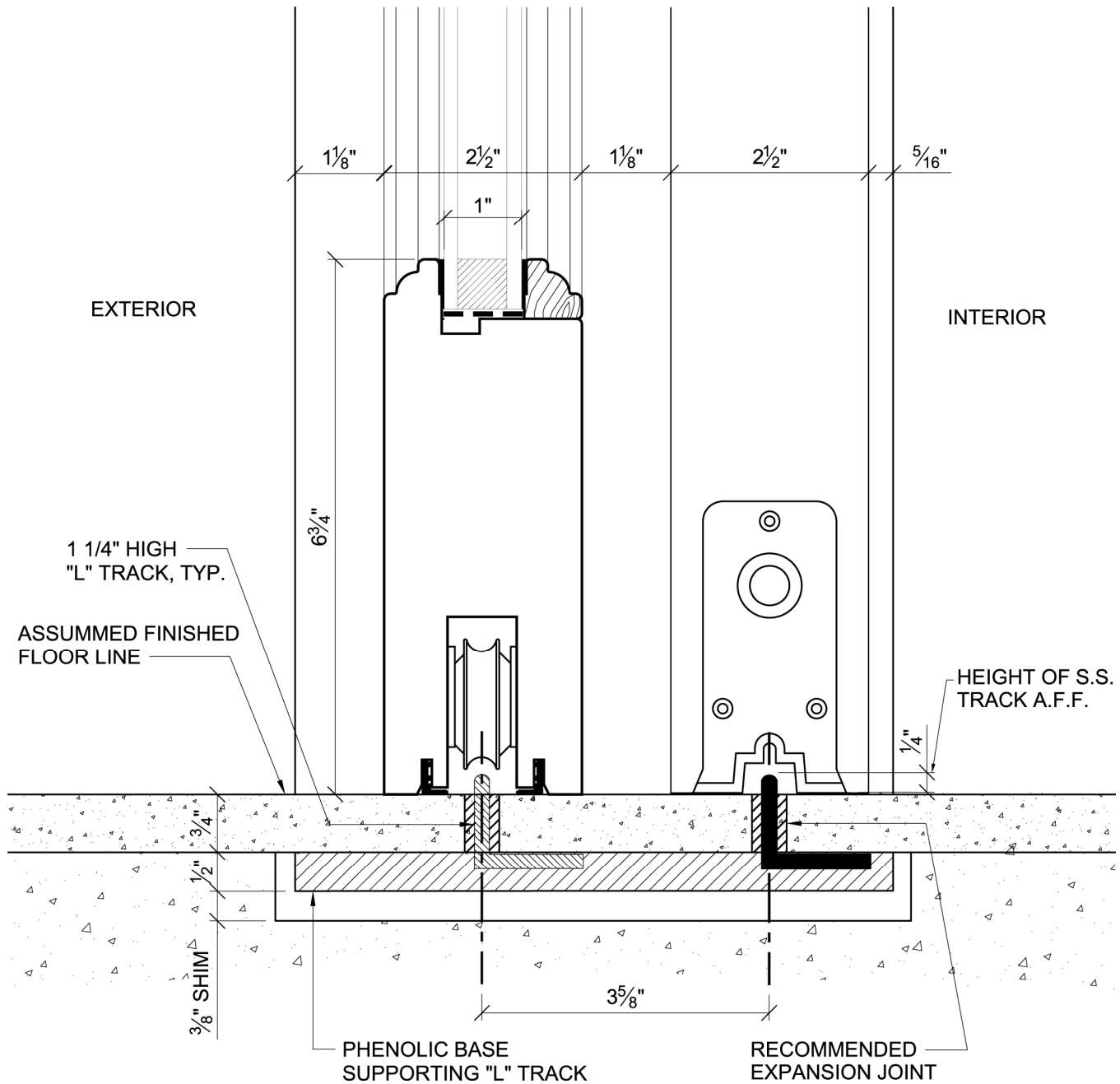

# PXX XXP (Teak Track Option): Sill Detail

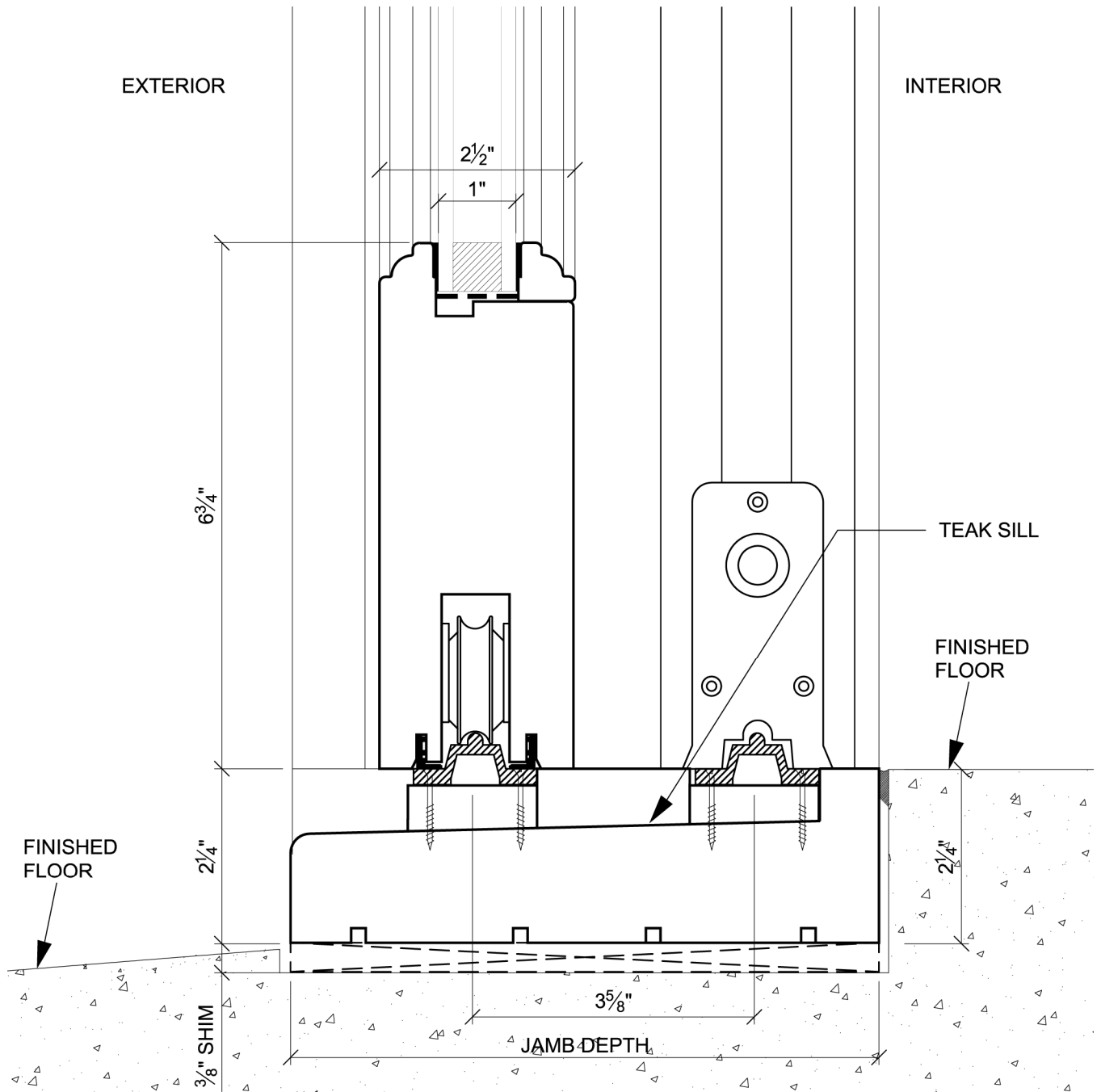

# PXX XXP (Flush): Meeting Stiles Detail

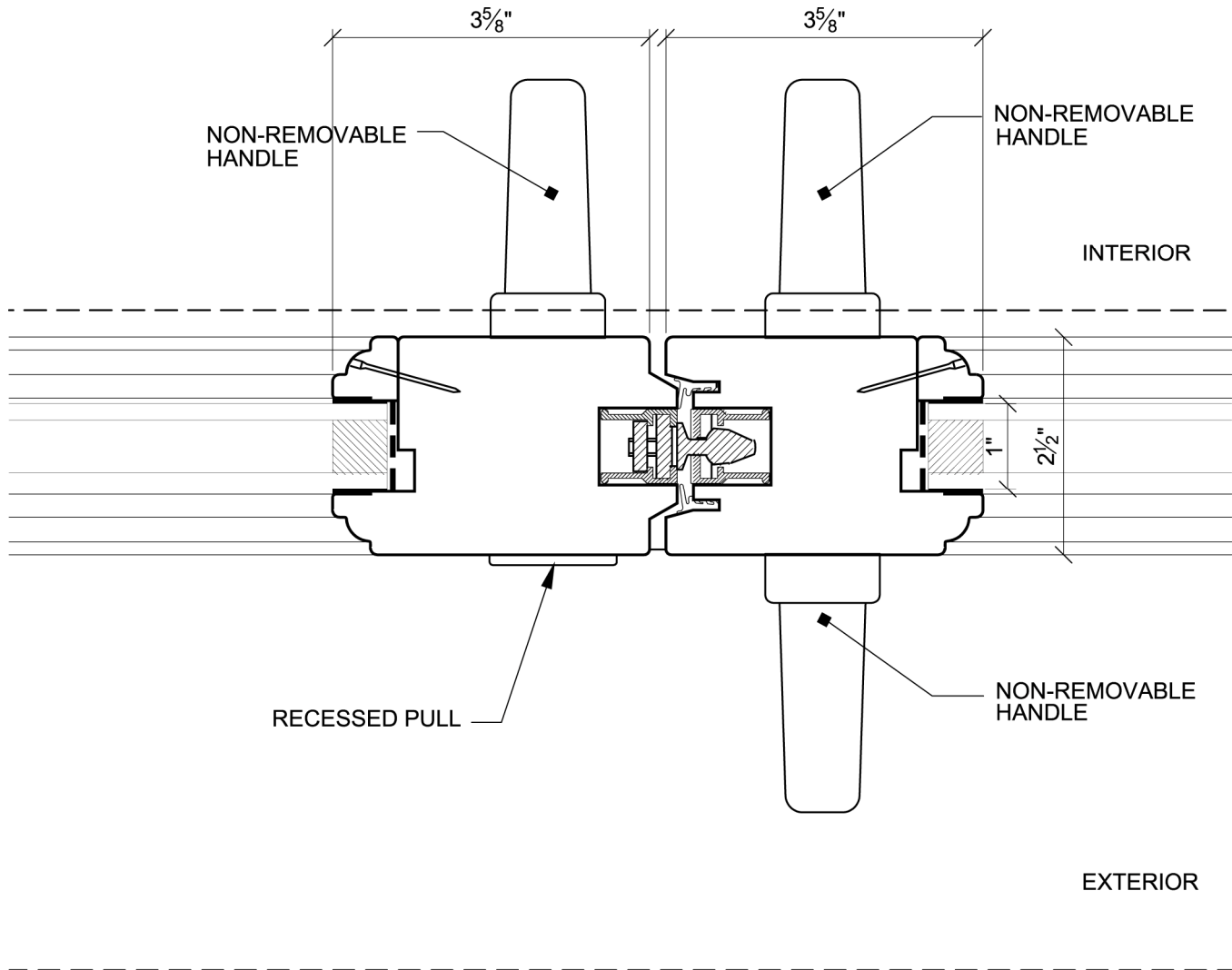

# PXX XXP (Flush): Interlocker Detail

INTERIOR

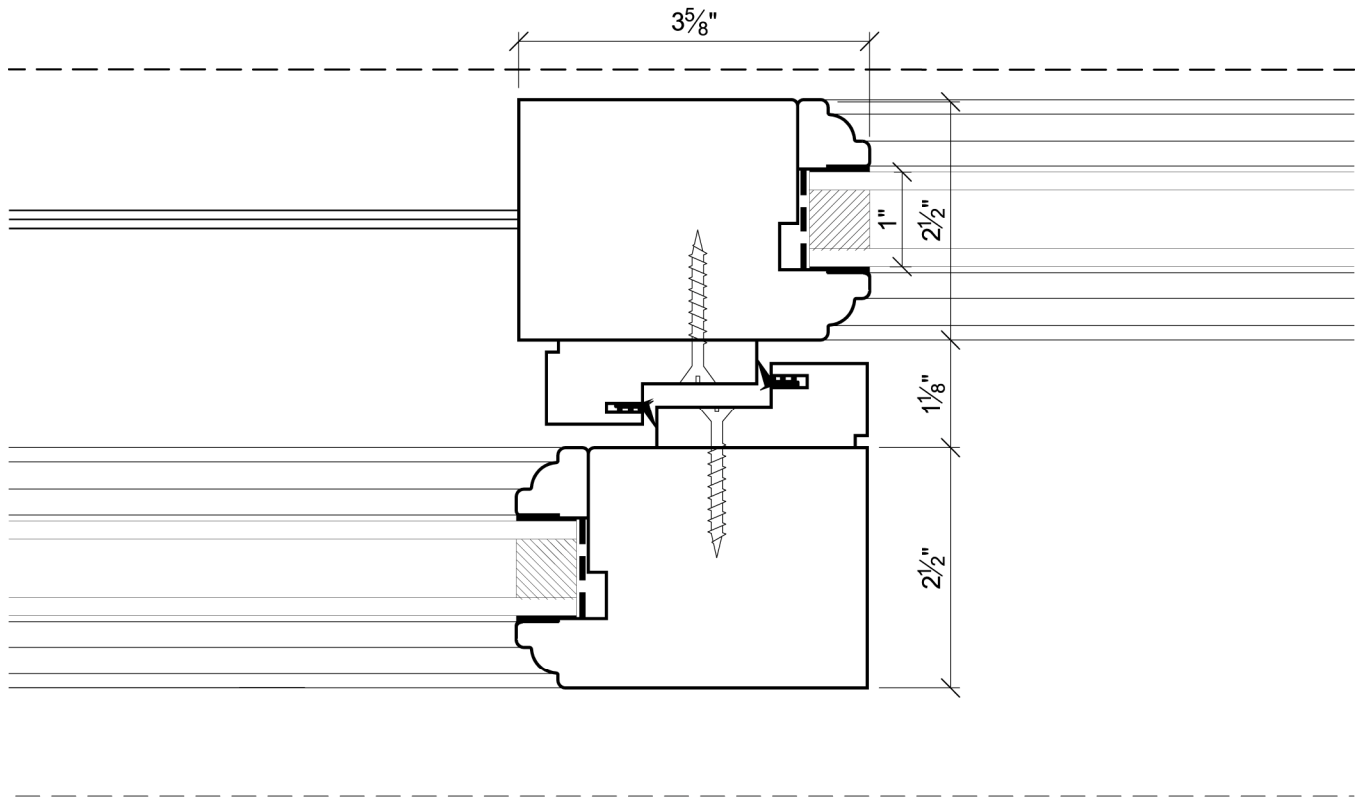

EXTERIOR

# PXX XXP (Flush): Interlocker Detail at Jamb Pocket

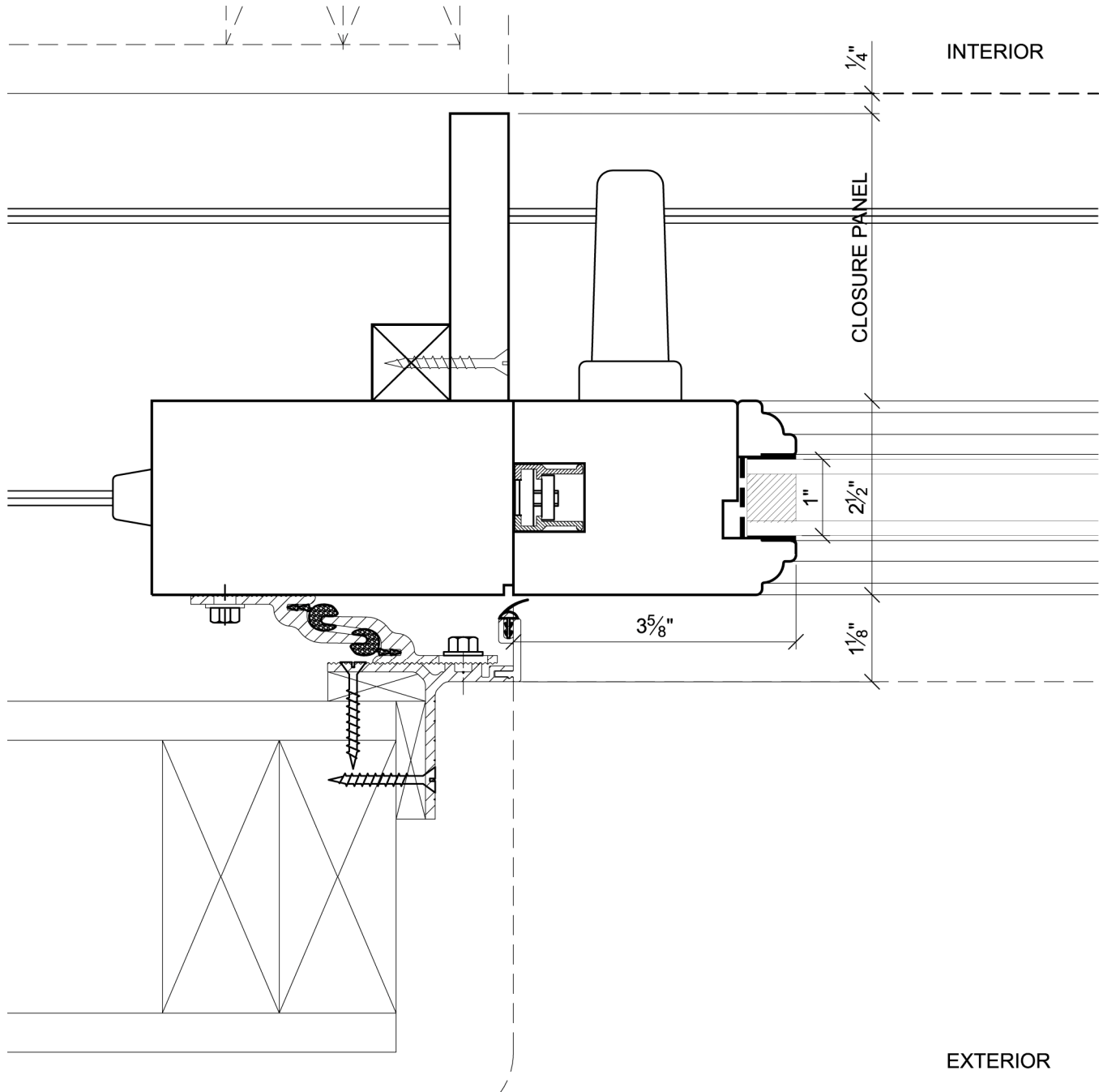



# Wood Lift-and-Slide Doors

(rev. 6.21.06)



## OXXO (Flush): Exterior Elevation

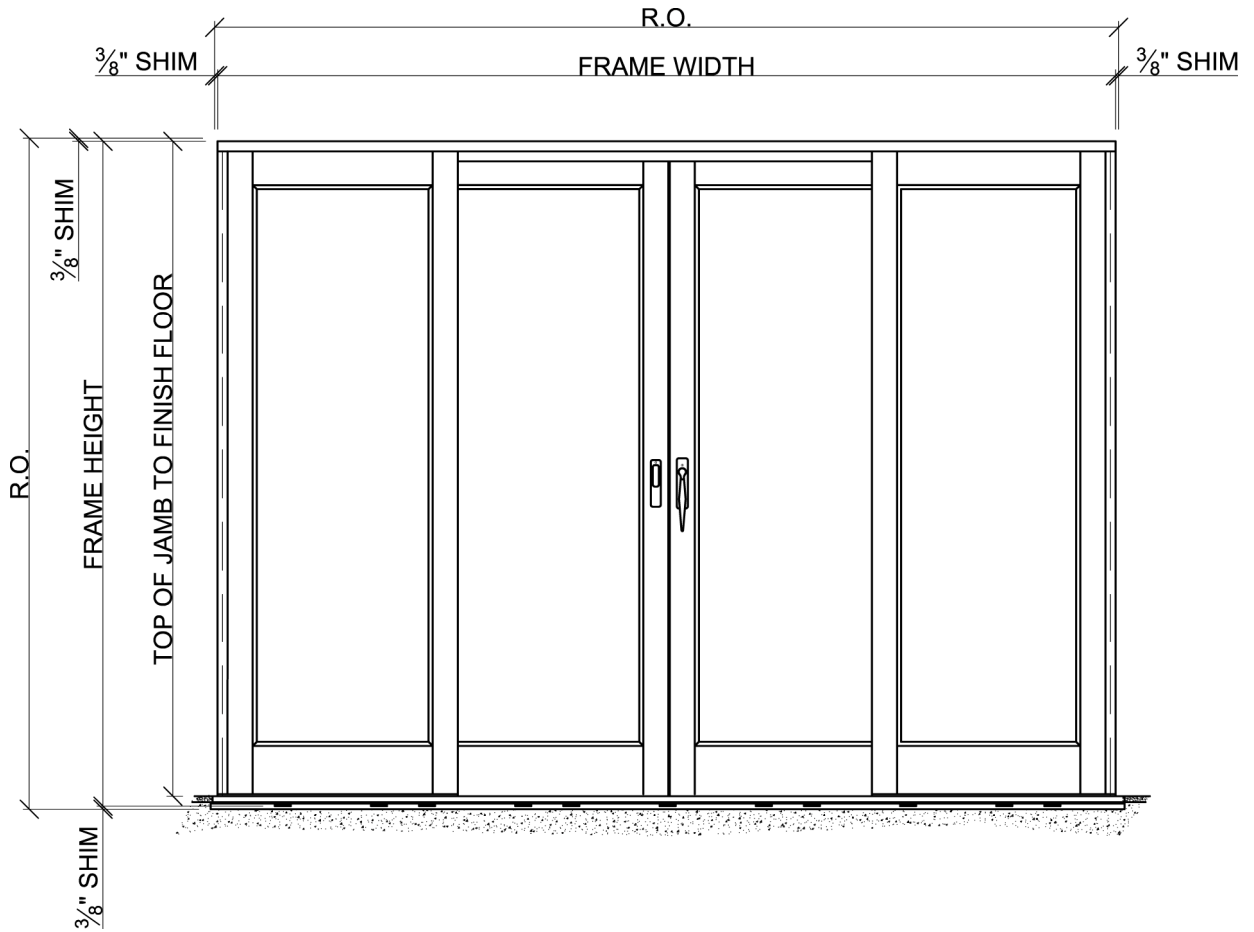

# OXXO (Flush): Vert. Section @ Fixed Panel

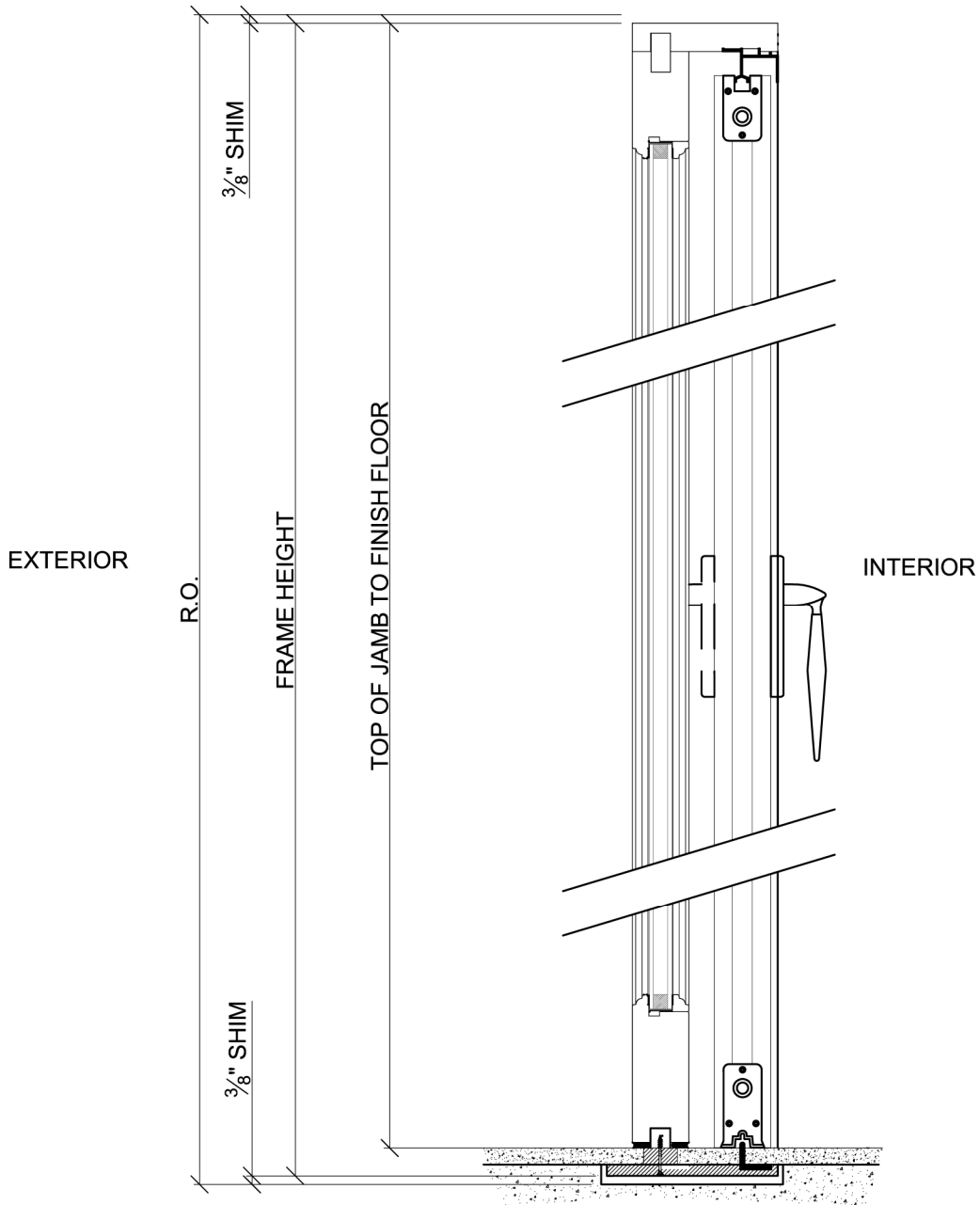

**OXXO (Flush): Vert. Section @ Operable Panel**

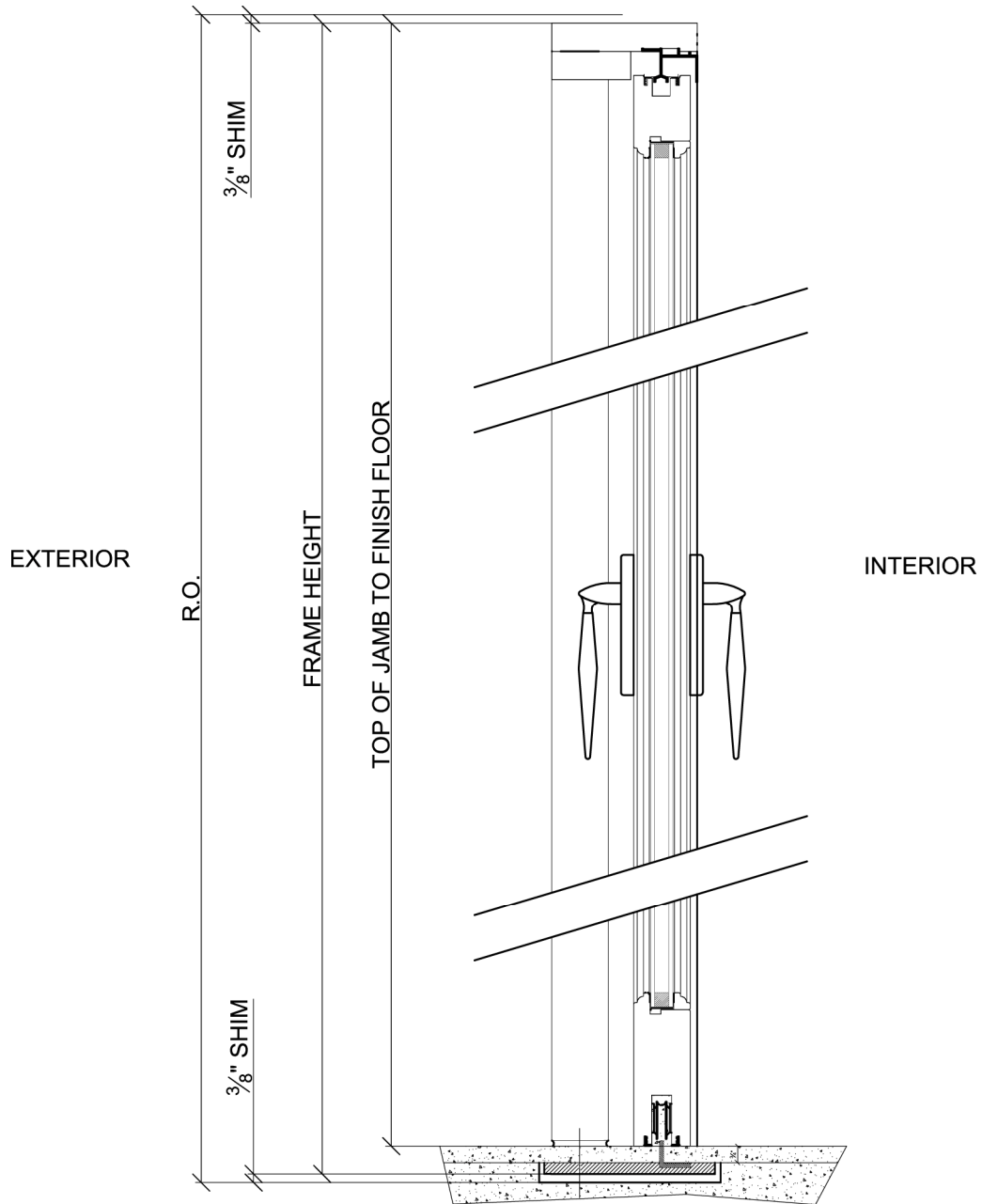

# OXXO (Flush): Plan Section

INTERIOR

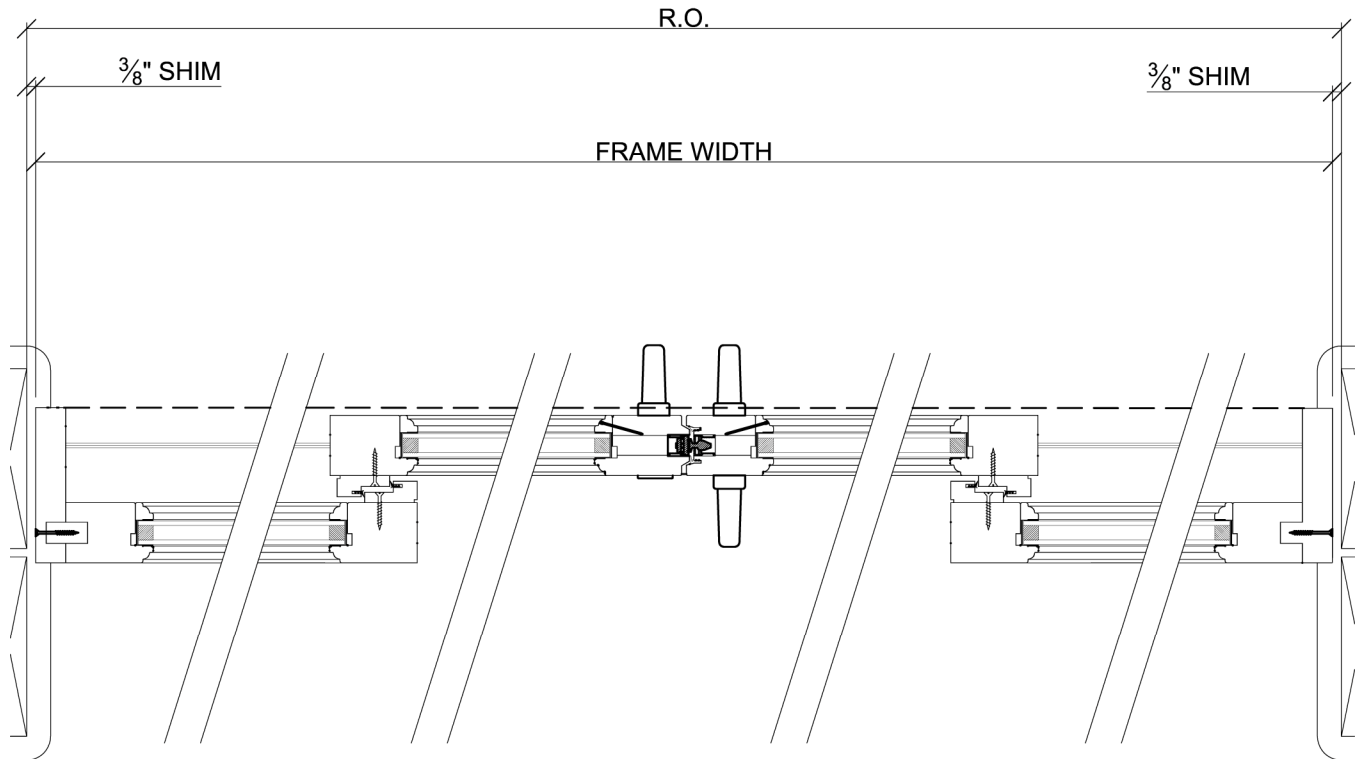

EXTERIOR

**OXXO (Flush): Head Detail @ Fixed Panel**

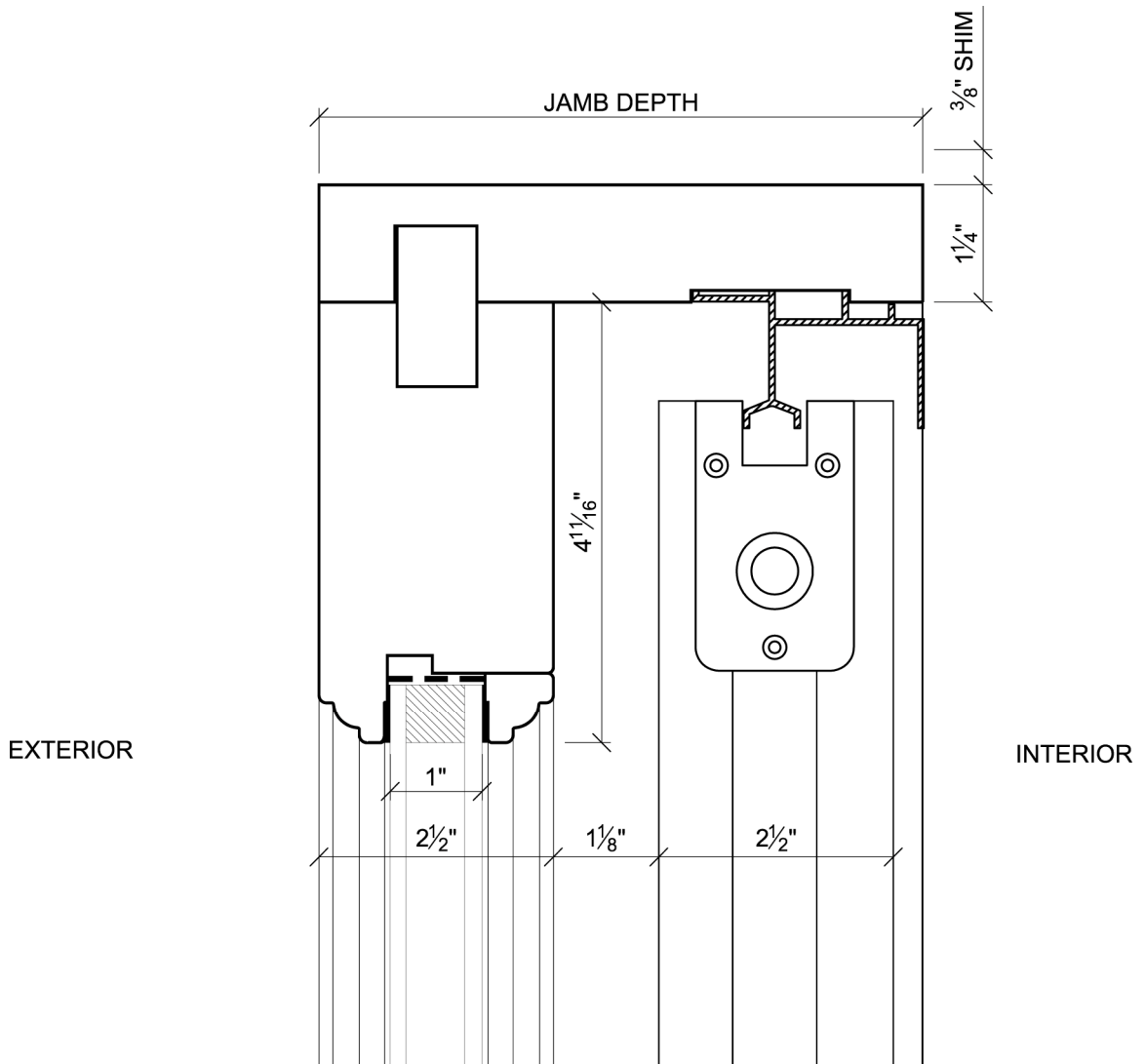

# OXXO (Flush): Head Detail @ Operable Panel

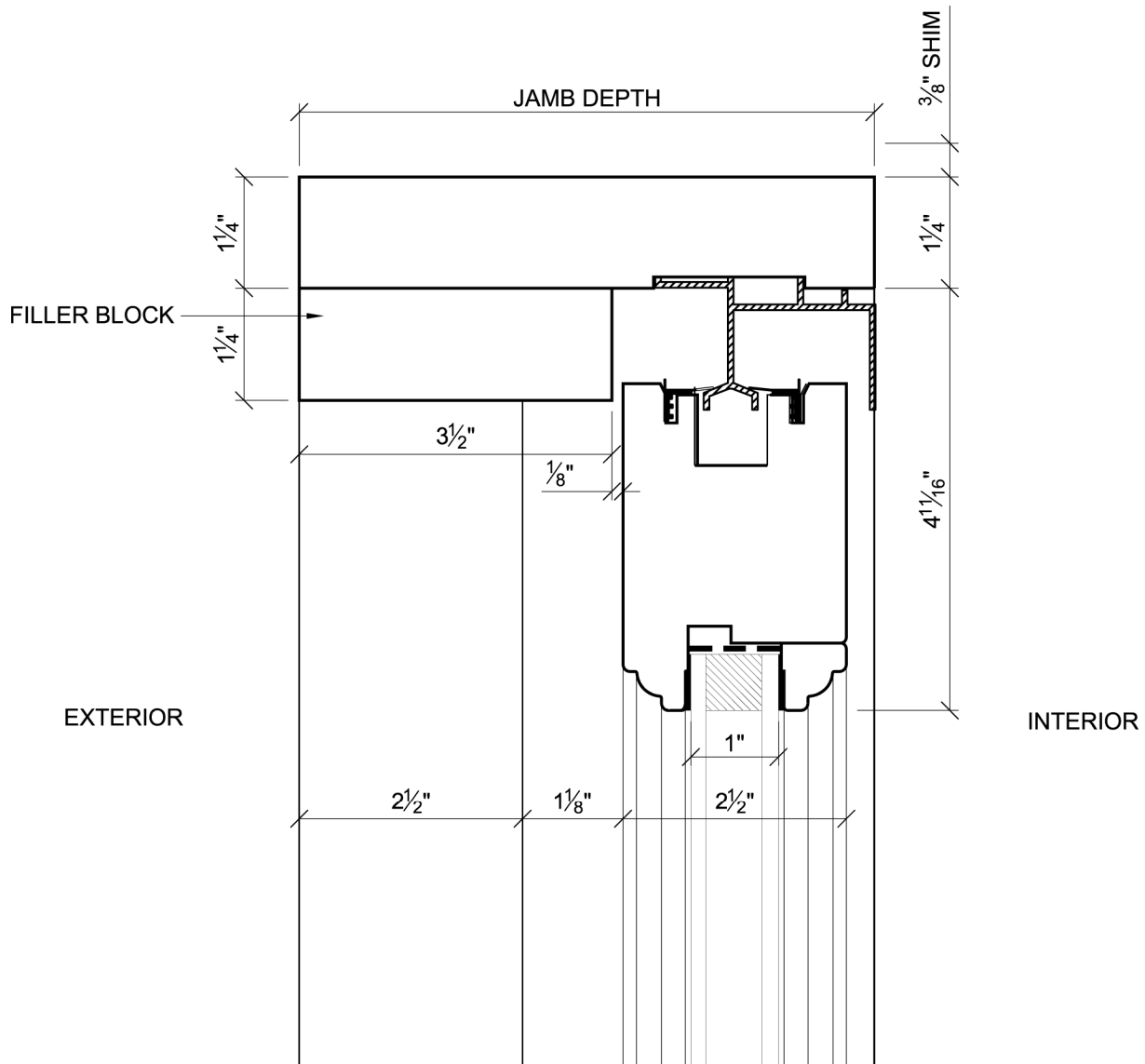

# OXXO (Flush Track Option): Sill Detail @ Fixed Panel

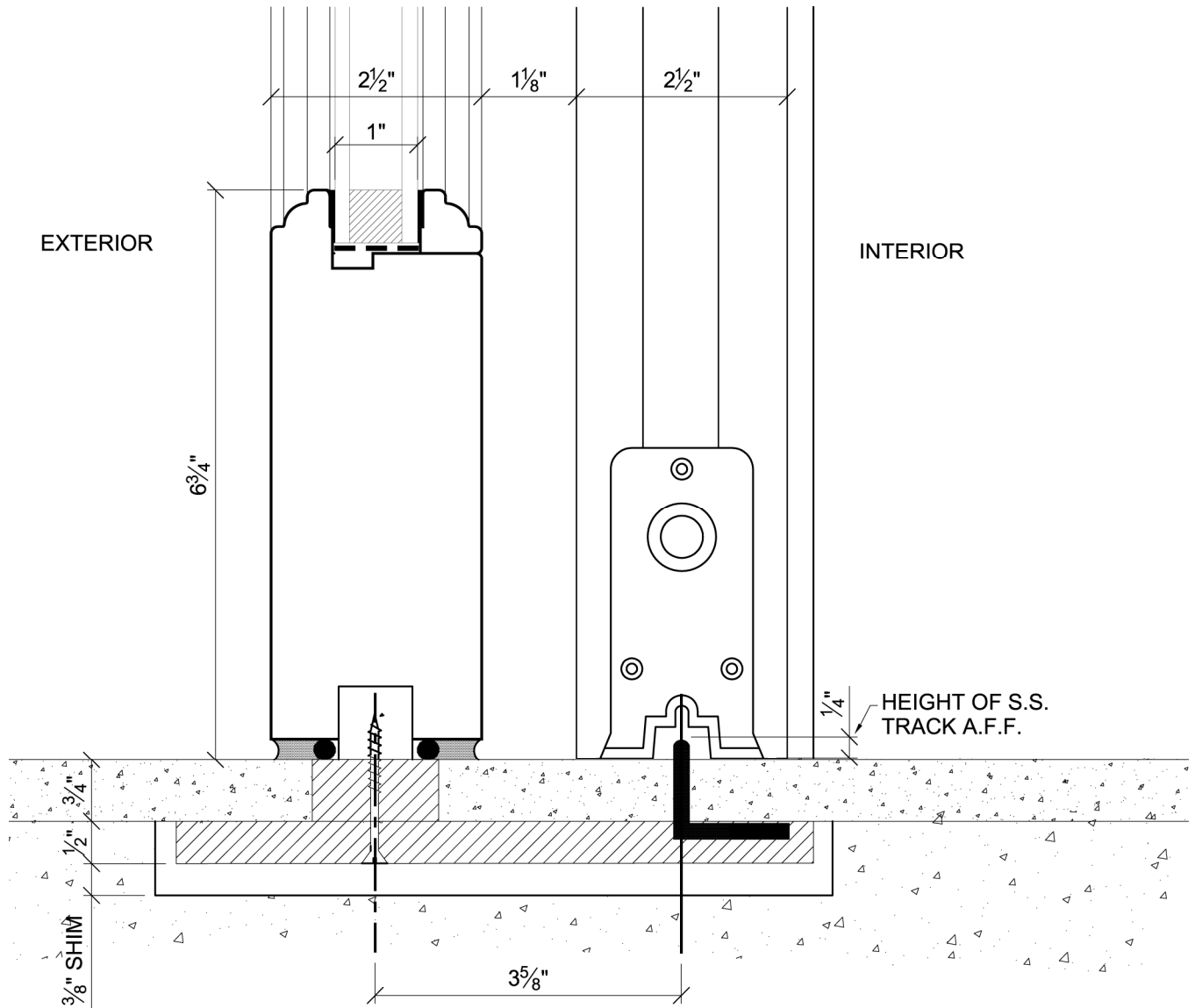

# OXXO (Flush Track Option): Sill Detail @ Operable Panel

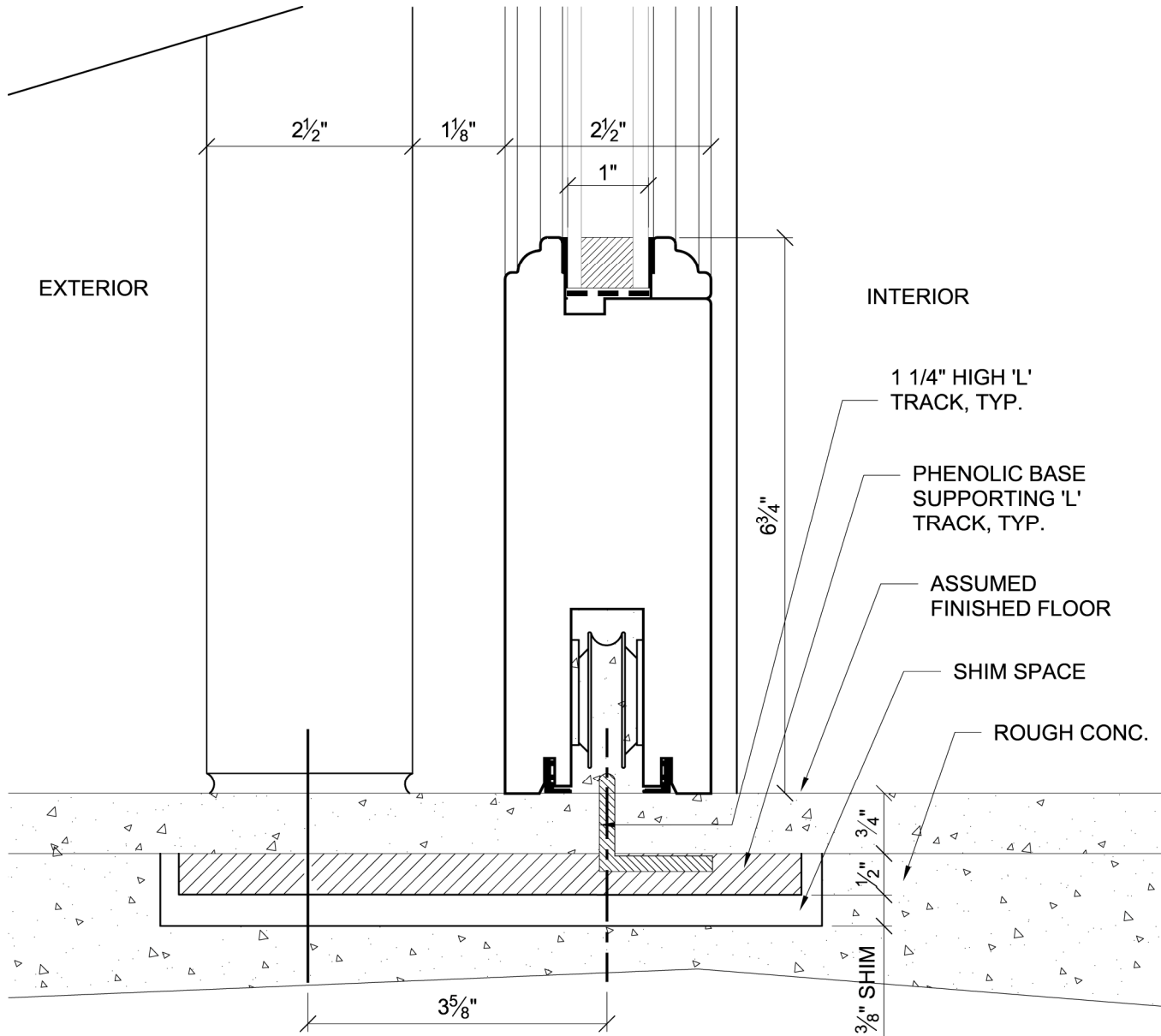



# OXXO (Flush): Jamb Detail

