

turnstone®

systems thought starters



Kick® thought starter application cards 1-12

turnstone

A Steelcase Company

For more information, call your
Steelcase/Turnstone representative at
800.333.9939 or visit us on-line
at turnstonefurniture.com

©2004 Steelcase Inc.,
Grand Rapids MI 49501
All rights reserved.
Printed in the U.S.A. on recycled paper.♻️
Data subject to change without notice.

à la carte, Data Duct, Details, Downspout,
Groupwork, Kick, Let's B, Lightolier,
Sora, Steelcase, Turnstone, Utility Bar are
trademarks owned by Steelcase
Development Corporation.

Turnstone Thought Starters

Let's play "what if".

Take Kick® systems furniture and consider your options. A value-priced system with a full statement of line. Aesthetics from funky to traditional. 120° planning and other configuration choices. Stackable, load-bearing panels, and multiple panel skin options. Simple reconfiguration in the field. Plus, Kick plays well with other Turnstone® and Steelcase® products.

This is just a start of what Kick can do.

Now it's your turn.

For downloadable files of these thought starters, visit turnstonefurniture.com/starters



Upmount metal bins offer flexible overhead storage while providing additional privacy.

Mobile pedestals can be repositioned within the workstation to suit personal workstyles.

Peninsula worksurfaces support collaboration within individual workstations.

Glass stackers allow light into workstations while creating aesthetic interest.

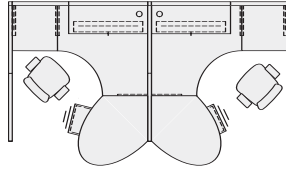

turnstone

A Steelcase Company

For downloadable files of these thought starters, visit turnstonefurniture.com/starters.

©2004 Turnstone
04-0006677 Turnstone Systems
Thought Starters 8/04

Qty	Description	Style Number	Qty	Description	Style Number
2	Panel - tackable, 54"x42"	TSAPF5442	2	Mobile pedestal with seat cushion	TS2PBF22MC
2	Panel - tackable, 54"x30"	TSAPF5430	3	Trim - vertical, EOR, 54"	TSAPTE54
6	Panel - tackable, 42"x36"	TSAPF4236	3	Trim - vertical, corner, 54"	TSAPTC54
2	Worksurface - corner, curved, 24"x48"	TSAWCC2448	2	Connector - panel, COH, inline, corner	TSAPBCOH
2	Worksurface - peninsula, angled, 24"x48"	TSAWPA2448	2	Kit - bin, upmount, 42"	TSASBUK42
2	Worksurface - straight, 24"x24"	TSAWS2424	4	Cantilever	TSATCANT
2	Storage bin - overhead, w/lock, 42"	TSASB42L	2	Sphere-power/comm, 2 outlet, 6' pwr cord	PTDMGB3
2	Support - worksurface, side	TSATSIDE			
2	Support - post (full height; no casters)	TSATP27			
3	Glass stacker, 12"x72"	TSAPS1272G			

Total workstation cluster list: **\$ 10,378 (US)**
Let's B™ seating as shown, list each: **\$ 485 (US)**

(Kick® base fabrics and finishes. Prices may vary depending on specification, code restrictions, etc.)



Kick® 2-pack (4' x 8' workstation)

Sliding doors create high-performance private work spaces in a very small footprint.



Glass stackers offer a translucent option and make smaller spaces feel more open.

Laminate common shelves save valuable footprint space while providing surface for piling.

Tackable acoustical panels provide visual and acoustical privacy for task work.

turnstone

A Steelcase Company

For downloadable files of these thought starters, visit turnstonefurniture.com/starters.

©2004 Turnstone
04-0006677 Turnstone Systems
Thought Starters 8/04

Qty	Description	Style Number	Qty	Description	Style Number
5	Panel - tackable, 66"x48"	TSAPF6648	4	Trim - vertical, EOR, 66"	TSAPTE66
2	Panel - tackable, 42"x48"	TSAPF4248	2	Connector - panel, COH, inline, corner	TSAPBCOH
2	Panel - tackable, 42"x36"	TSAPF4236	4	Cantilever	TSATCANT
2	Panel - tackable, 42"x24"	TSAPF4224			
2	Worksurface - straight, 24"x48"	TSAWS2448			
2	Storage bin - overhead, w/lock, 48"	TSASB48L			
2	Laminate common shelf, 15"x48"	TSASLCL48			
2	Glass stacker, 24"x48"	TSAPS2448G			
2	Glass stacker, 24"x42"	TSAPS2442G			
2	Glass stacker, 24"x36"	TSAPS2436G			
2	Universal sliding panel door, 66"x36"	TSAPDSU6636			
6	Trim - vertical, corner, 66"	TSAPTC66			

Total workstation cluster list: **\$ 13,395 (US)**
Jacket™ seating as shown, list each: **\$ 755 (US)**

(Kick® base fabrics and finishes. Prices may vary depending on specification, code restrictions, etc.)

turnstone®

systems thought starter 3



Kick® 2-pack (7' x 8' workstation left, 8' x 8' workstation right)

Simple metal binder bins offer easily accessed storage in a clean aesthetic.

Compatibility with Steelcase products like Lightolier™ Sora™ allows a multitude of options.

Tackable acoustical panels provide visual and acoustical privacy for task work.

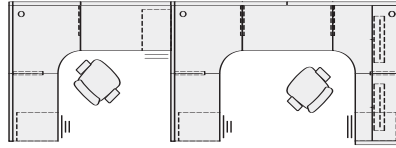

turnstone

A Steelcase Company

For downloadable files of these thought starters, visit turnstonefurniture.com/starters.

©2004 Turnstone
04-0006677 Turnstone Systems
Thought Starters 8/04

Qty	Description	Style Number	Qty	Description	Style Number
2	Panel - tackable, 66"x36"	TSAPF6636	2	Pedestal filler	TS2PF2
3	Panel - tackable, 54"x60"	TSAPF5460	2	Trim - vertical, corner, 66"	TSAPTC66
2	Panel - tackable, 54"x24"	TSAPF5424	1	Trim - vertical, EOR, 54"	TSAPTE54
4	Panel - tackable, 42"x36"	TSAPF4236	2	Trim - vertical, EOR, 42"	TSAPTE42
3	Worksurface - corner, curved, 24"x36"	TSAWCC2436	2	In-line support plates	TSATPL20
3	Worksurface - straight, 24"x36"	TSAWS2436	3	Connector - panel, COH, inline, corner	TSAPBCOH
2	Worksurface - straight, 24"x48"	TSAWS2448	5	Cantilever	TSATCANT
2	Storage bin - overhead, w/lock, 36"	TSASB36L	1	Tie plate	TSATTIE
2	Under-worksurface pedestal, 22"D file/file	TS2PFF2U			
2	Under-worksurface pedestal, 22"D box/box/file	TS2PBBF2U			

Total workstation cluster list: **\$ 8,655 (US)**

Let's B™ seating as shown, list each: **\$ 510 (US)**

(Kick® base fabrics and finishes. Prices may vary depending on specification, code restrictions, etc.)

turnstone®

systems thought starter 4



Kick® 2-pack (6' x 7½' workstation)

Glass stackers allow light into workstations while creating aesthetic interest.

Upmount metal bins offer flexible overhead storage while providing additional privacy.

Mobile Groupwork table can be reconfigured within the space to handle a multitude of tasks.

Deep corners combine with transition worksurfaces for maximum footprint efficiency.

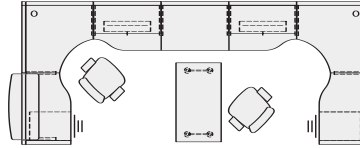

turnstone

A Steelcase Company

For downloadable files of these thought starters, visit turnstonefurniture.com/starters.

©2004 Turnstone
04-0006677 Turnstone Systems
Thought Starters 8/04

Qty	Description	Style Number	Qty	Description	Style Number
9	Panel - tackable, 42"x36"	TSAPF4236	2	Under worksurface pedestals	TS2PBBF22U
2	Panel - tackable, 42"x24"	TSAPF4224		22"D box/box/file	
1	Worksurface - straight, 24"x36"	TSAWS2436	1	Table, rectangle, 24"x48", T-leg with leveler	TS4R2448T
1	Worksurface - transaction, 16"x36"	TSAWT1636	1	with casters	option
2	Transition worksurface, 24"x18"x36"	TSAWX241836	3	Trim - vertical, corner, 54"	TSAPTC54
2	Transition worksurface, 18"x24"x36"	TSAWX182436	2	Trim - vertical, EOR, 42"	TSAPTE42
2	Curved corner worksurface, 18"x36"	TSAWCC1836	1	Trim - vertical, corner, 42"	TSAPTC42
2	Storage bin - overhead, w/lock, 36"	TSASB36L	2	Kit - bin, upmount, 36"	TSASBUK36
2	Support - worksurface, side	TSATSIDE	6	Cantilever	TSATCANT
1	Glass stacker 12"x72"	TSAPS1272G			
6	Glass stacker, 12"x36"	TSAPS1236G			

Total workstation cluster list: **\$ 11,047 (US)**

Let's B™ seating as shown, list each: **\$ 485 (US)**

(Kick® base fabrics and finishes. Prices may vary depending on specification, code restrictions, etc.)



Kick® 3-pack (4' x 4' workstation)

Glass stackers create aesthetic interest and added privacy.

Power and Communication Spheres provide a worksurface connection point.

Mobile pedestals can be repositioned within the workstation to suit personal workstyles.

Spanner worksurfaces support collaboration within individual workstations.

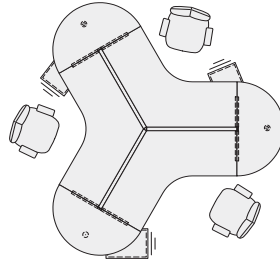

Qty	Description	Style Number	Qty	Description	Style Number
3	Panel - tackable, 42"x48"	TSAPF4248	1	120° vertical corner trims, 54"	TSAPTCY54
3	Worksurface - spanner, 25"x 50"	TSAWN50	6	Cantilever	TSATCANT
3	120° corner worksurfaces, 24"x42"	TSAWY2442	3	Sphere-power/comm, 2 outlet, 6' pwr cord	PTDMGB3
3	Support - post (full height; no casters)	TSATP27			
3	Glass stacker, 12"x48"	TSAPS1248G			
3	Mobile pedestal with seat cushion	TS2PBF22MC			
3	Trim - vertical, EOR, 54"	TSAPTE54			
3	120° connectors	TSAPB120			

turnstone

A Steelcase Company

For downloadable files of these thought starters, visit turnstonefurniture.com/starters.

©2004 Turnstone
04-0006677 Turnstone Systems
Thought Starters 8/04

Total workstation cluster list: **\$ 7,832 (US)**
à la carte™ seating as shown, list each: **\$ 325 (US)**

(Kick® base fabrics and finishes. Prices may vary depending on specification, code restrictions, etc.)

turnstone®

systems thought starter 6



Kick® 2-pack (6½' x 9' workstation)

Upmount bins offer flexible overhead storage while providing additional privacy.

Spanner worksurfaces support collaboration between workstations.

High top caps allow lay-in cable routing at the top of the panel.

Segmented panels create visual interest.

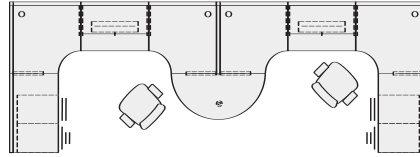

turnstone

A Steelcase Company

For downloadable files of these thought starters, visit turnstonefurniture.com/starters.

©2004 Turnstone
04-0006677 Turnstone Systems
Thought Starters 8/04

Qty	Description	Style Number	Qty	Description	Style Number
2	Segmented tackable panels, option 1, 54"x42"	TSAPL5442	1	Support - post (full height; no casters)	TSATP27
9	Segmented tackable panels, option 1, 54"x36"	TSAPL5436	2	Under-worksurface pedestal, 22"D file/file	TS2PFF22U
1	Worksurface - spanner, 25"x50"	TSAWN50	2	Under-worksurface pedestal, 22"D box/box/file	TS2PBBF22U
2	Worksurface - straight, 24"x42"	TSAWS2442	3	Trim - vertical, EOR, 54	TSAPTE54
2	Worksurface - straight, 24"x36"	TSAWS2436	3	Trim - vertical, corner, 54"	TSAPTC54
4	Worksurface - corner, curved, 24"x36"	TSAWCC2436	8	Cantilever	TSATCANT
2	Storage bin - overhead, w/ lock, 36"	TSASB36L	2	Sphere-power/comm, 2 outlet, 6' pwr cord	PTDMGB3
2	Kit - bin, upmount, 36"	TSASBUK36			

Total workstation cluster list: **\$ 11,346 (US)**
Let's B™ seating as shown, list each: **\$ 325 (US)**

(Kick® base fabrics and finishes. Prices may vary depending on specification, code restrictions, etc.)

turnstone®

systems thought starter 7



Kick® 2-pack (6½' x 9' workstation)

Laminate common shelves provide open, low-cost storage or display space.

Spanner worksurfaces support collaboration between workstations.

Data duct™ allows simple lay-in cable routing at the top of the panel.

Segmented panels create visual interest.

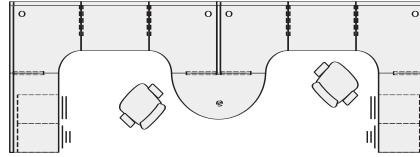

turnstone

A Steelcase Company

For downloadable files of these thought starters, visit turnstonefurniture.com/starters.

©2004 Turnstone
04-0006677 Turnstone Systems
Thought Starters 8/04

Qty	Description	Style Number	Qty	Description	Style Number
2	Segmented tackable panels, option 1, 54"x42"	TSAPL5442	3	Trim - vertical, EOR, 54"	TSAPTE54
9	Segmented tackable panels, option 1, 54"x36"	TSAPL5436	3	Trim - vertical, corner, 54"	TSAPTC54
4	Worksurface - corner, curved, 24"x36"	TSAWCC2436	8	Cantilever	TSATCANT
2	Worksurface - straight, 24"x36"	TSAWS2436	2	Sphere-power/comm, 2 outlet, 6' pwr cord	PTDMGB3
2	Worksurface - straight, 24"x42"	TSAWS2442	2	Utility bar	TSADU36
1	Worksurface - spanner, 25"x50"	TSAWN50	6	Data duct with trestle	TSADT036
1	Support - post (full height; no casters)	TSATP27	2	Downspout data box	TSADB
2	Laminate common shelves, 36"	TSASLCL36			
2	Under-worksurface pedestal, 22"D file/file	TS2PFF22U			
2	Under-worksurface pedestal, 22"D box/box/file	TS2PBBF22U			

Total workstation cluster list: **\$ 11,280 (US)**
Let's B™ seating as shown, list each: **\$ 485 (US)**

(Kick® base fabrics and finishes. Prices may vary depending on specification, code restrictions, etc.)



Kick® 6-pack (4' x 4' workstation)

Spanner worksurfaces support collaboration between workstations.

Glass stackers allow light into workstations while creating aesthetic interest.

Side access towers provide accessible, dense storage.

Tackable acoustical panels provide visual and acoustical privacy for task work.

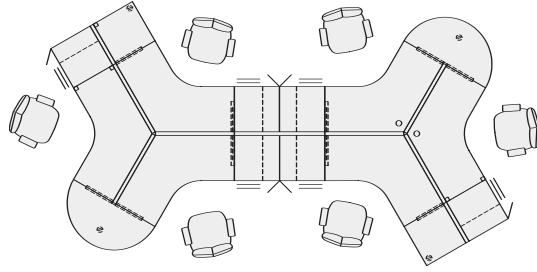

Qty	Description	Style Number	Qty	Description	Style Number
6	Panel - tackable, 42"x42"	TSAPF4242	2	Tower Too, hinged right with wardrobe and hook, 24"x24"x54"	TS2TWR54R
1	Panel - tackable, 54"x48"	TSAPF5448	4	Trim - vertical, EOR, 54"	TSAPTE54
2	Panel - tackable, 54"x24"	TSAPF5424	2	120° vertical corner trims	TSAPTC742
2	Worksurface - spanner, 25"x50"	TSAWN50	6	120° connectors, pkg of 2	TSAPB120
2	Worksurface - visitor, 24"x24"	TSAWV2424	4	COH connector	TSAPBCOH
6	120° worksurface, 24"x42"	TSAWY2442	12	Cantilever	TSATCANT
4	Support - post (full height; no casters)	TSATP27			
6	Glass stacker, 12"x42"	TSAPS1242G			
4	Tower Too, hinged left with wardrobe and hook, 24"x24"x54"	TS2TWR54L			

turnstone

A Steelcase Company

For downloadable files of these thought starters, visit turnstonefurniture.com/starters.

©2004 Turnstone
04-0006677 Turnstone Systems
Thought Starters 8/04

Total workstation cluster list: **\$ 17,999 (US)**
à la carte™ seating as shown, list each: **\$ 325 (US)**

(Kick® base fabrics and finishes. Prices may vary depending on specification, code restrictions, etc.)



Kick® 3-pack (6' x 6' workstation)

Freestanding storage towers provide accessible, dense storage.

Angle peninsulas support collaboration within the workstation.

Worksurface-mounted Power and Communication Spheres provide a worksurface connection point.

Details™ slatwall rails mount in panel tracks to accept a variety of Details organizational work tools.

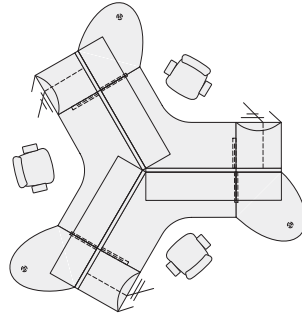

turnstone

A Steelcase Company

For downloadable files of these thought starters, visit turnstonefurniture.com/starters.

©2004 Turnstone
04-0006677 Turnstone Systems
Thought Starters 8/04

Qty	Description	Style Number	Qty	Description	Style Number
3	Panel - tackable, 54"x48"	TSAPF5448	3	120° connectors	TSAPB120
3	Panel - tackable, 54"x24"	TSAPF5424	6	Cantilever	TSATCANT
3	Worksurface - peninsula, angled, 24"x 48"	TSAWPA2448	3	Sphere-power/comm, 2 outlet, 6' pwr cord	PTDMGB3
1	120° vertical corner trims, 54"	TSAPTCY54			
3	Support - post (full height; no casters)	TSATP27			
3	Laminate common shelves, 24"	TSASLCL24			
3	Tower too, hinged left with wardrobe and hook, 24"x24"x54"	TS2TWR54L			
3	Trim - vertical, EOR, 54"	TSAPTE54			
3	120° corner worksurfaces, 24"x48"	TSAWY2448			

Total workstation cluster list: **\$ 10,109 (US)**
Let's B™ seating as shown, list each: **\$ 485 (US)**

(Kick® base fabrics and finishes. Prices may vary depending on specification, code restrictions, etc.)

turnstone®

systems thought starter 10



Kick® 6-pack (6½' x 6½' workstation)

Spanning worksurfaces support collaboration within the workstation.

Mobile pedestals can be repositioned within the workstation to suit personal workstyles.

Worksurface-mounted Power and Communication Spheres provide a worksurface connection point.

Tackable acoustical panels provide visual and acoustical privacy for task work.

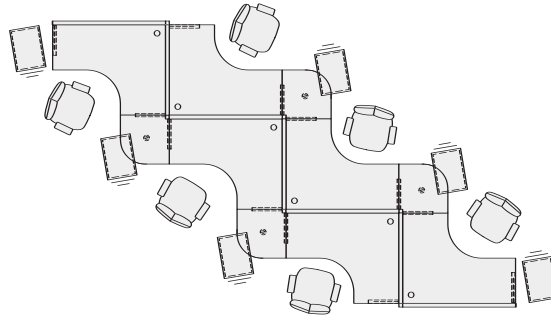

Qty	Description	Style Number	Qty	Description	Style Number
4	Panel - tackable, 42"x60"	TSAPF4260	2	Trim - vertical, EOR, 42"	TSAPTE42
3	Panel - tackable, 42"x48"	TSAPF4248	12	Cantilever	TSATCANT
6	Worksurface - corner, curved, extended, 24"x24"x60"x48"	TSawe226048	6	Sphere-power/comm, 2 outlet, 6' pwr cord	PTDMGB3
4	Worksurface - linking, 26"x26"	TSaWL2626			
4	Support - post (full height; no casters)	TSaTP27			
6	Mobile pedestal with seat cushion	TS2PBF22MC			
6	Trim - vertical, corner, 42"	TSaPTC42			

turnstone

A Steelcase Company

For downloadable files of these thought starters, visit turnstonefurniture.com/starters.

©2004 Turnstone
04-0006677 Turnstone Systems
Thought Starters 8/04

Total workstation cluster list: **\$ 12,347 (US)**
à la carte™ seating as shown, list each: **\$ 325 (US)**

(Kick® base fabrics and finishes. Prices may vary depending on specification, code restrictions, etc.)



Full glass panels create an open look in smaller footprints.

Segmented panels create visual interest.

Glass stackers allow light into workstations while creating aesthetic interest.

Worksurface-mounted Power and Communication Spheres and Communication Spheres provide a worksurface connection point.

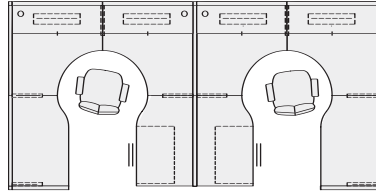

turnstone

A Steelcase Company

For downloadable files of these thought starters, visit turnstonefurniture.com/starters.

©2004 Turnstone
04-0006677 Turnstone Systems
Thought Starters 8/04

Qty	Description	Style Number	Qty	Description	Style Number
4	Segmented panel, 66"x48", with option 5	TSAPL6648	3	Trim - vertical, corner, 66"	TSAPTC66
3	Segmented panel, 54"x48", with option 1	TSAPL5448	2	Trim - vertical, corner, 54"	TSAPTC54
3	Panel - tackable, 42"x48"	TSAPF4248	1	Trim - vertical, EOR, 54"	TSAPTE54
2	Worksurface - transition, 24"x30"x48"	TSAWX243048	2	Trim - vertical, EOR, 42"	TSAPTE42
2	Worksurface - transition, 30"x24"x48"	TSAWX302448	6	Connector - panel, COH, inline, corner	TSAPBCOH
4	Worksurface - corner, curved, 24"x48"	TSAWCC2448	6	Cantilever	TSATCANT
4	Storage bin - overhead, w/ lock, 48"	TSASB48L	4	Sphere-power/comm, 2 outlet, 6' pwr cord	PTDMGB3
2	Support - worksurface, side	TSATSIDE			
3	Glass stacker, 12"x48"	TSAPS1248G			
2	Panel-glass, 42"x30"	TSAPG4230			
2	Under-worksurface lateral file, 36"W	TS2F236UL			

Total workstation cluster list: **\$ 14,993 (US)**
Jacket® seating as shown, list: **\$ 755 (US)**

(Kick® base fabrics and finishes. Prices may vary depending on specification, code restrictions, etc.)



Kick® 2-pack (6' x 8' workstation)

Sliding door creates a high-performance private work space in a very small footprint.

Segmented panels create visual interest.

Glass stackers allow light into workstations while creating aesthetic interest.

Transaction worksurface mounts to 42"H panel walls to create reception station.

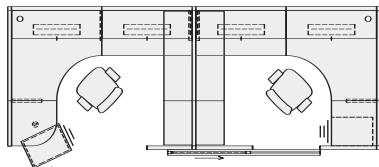

turnstone

A Steelcase Company

For downloadable files of these thought starters, visit turnstonefurniture.com/starters.

©2004 Turnstone
04-0006677 Turnstone Systems
Thought Starters 8/04

Qty	Description	Style Number	Qty	Description	Style Number
6	Segmented panel, 66"x48", with option 5	TSAPL6648	1	Universal sliding panel door, 66"x36"	TSAPDSU6636
3	Segmented panel, 66"x24", with option 5	TSAPL6624	1	Mobile pedestal with seat cushion	TS2PBF22MC
1	Segmented panel, 66"x30", with option 5	TSAPL6630	1	Under-worksurface pedestal, 22"D box/box/file	TS2PBBF22U
1	Panel - tackable, 42"x24"	TSAPF4224	1	Under-worksurface lateral file, 31"W	TS2F23OUL
1	Panel - tackable, 42"x48"	TSAPF4248	5	Trim - vertical, corner, 66"	TSAPTC66
1	Panel - tackable, 42"x30"	TSAPF4230	3	Trim - vertical, EOR, 66"	TSAPTE66
1	Worksurface - transaction, 16"x60"	TSAWT1660	1	Trim - vertical, EOR, 42"	TSAPTE42
2	Worksurface - corner, curved, 24"x48"	TSAWCC2448	2	Connector - panel, COH, inline, corner	TSAPBCOH
1	Worksurface - straight, 24"x24"	TSAWS2424	6	Cantilever	TSATCANT
2	Worksurface - straight, 24"x48"	TSAWS2448			
1	Worksurface - visitor, 24"x24"	TSAWV2424			
4	Storage bin - overhead, w/ lock, 48"	TSASB48L			
1	Glass stacker, 24"x30"	TSAPS2430G			
1	Support - post (full height; no casters)	TSATP27			
2	Laminate common shelf, 15"x48"	TSASLCL48			
2	Laminate common shelf, 15"x24"	TSASLCL24			

Total workstation cluster list: **\$14,403 (US)**
Let's B™ seating as shown, list each: **\$ 510 (US)**

(Kick® base fabrics and finishes. Prices may vary depending on specification, code restrictions, etc.)