

turnstone®

kick®
systems furniture



smart design | good value



kick

Consider Kick systems furniture from Turnstone when you want smart simplicity and clean design that's surprisingly affordable.





do more with less

The affordable, space-saving features of Kick help you use your real estate to the max.

▲ **Two-for-one value**
Mobile pedestals double as visitor seats with the addition of seat cushions – maximizing use and adding convenience.

▲ **Efficient**
With the 120° configuration, three people can work comfortably in a 10'x10' footprint.

▲ **Space-saving corners**
18" deep corners open up workstation space while supporting today's technology.



▲ **Slip-to-fit surfaces**
Versatile common shelves can be layered – making intelligent use of your vertical space.



▲ **Plan around architecture**
Off-module connections can be made in 1" increments, giving you flexibility to accommodate architecture and future changes.



▲ **surface materials**
Panel fabrics: Designtex About Face Y148 Coconut, Y162 Storm. Paint: 4799 Platinum. Laminates: 25T1 Winter on Maple, 275T Warm White. Let's B chairs: Bee 5E46 Nutmeg, 5E64 Pewter. Mobile pedestal cushion: COM Designtex Bsharp 2362-301. Martini table: Plastic 628T Natural. Jacket chair: Leather T802 Black. Fleece T221 Orange.



wired for success

With the intelligent simplicity of Kick, you get technology where and when you need it.

▲ **Clean, integrated, internal**
Power and data can be routed internally – providing secure, convenient access.

Optional high top caps accommodate more cables under a clean profile.

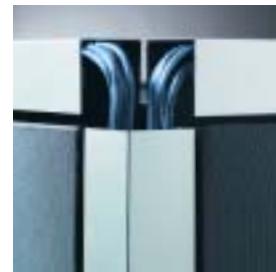

▲ **User adjustable**
External routing allows users to easily change and access utilities as needed.



▲ **surface materials**
Panel fabrics: Designtex About Face Y159 Tangerine, Y162 Storm. Translucent insert: 6507 Frosted Green. Paint: 4799 Platinum. Laminate: 25T1 Winter on Maple. Smoke vinyl: 2314 Dark Silver. Sweeper guest chairs: Buzz2 5F02 Orange, Plastic 631T Dark Grey. Paint 4799 Platinum. Jacket chair: Leather T802 Black, Fleece T221 Orange.



teamwork and privacy

Get both with the choices and combinations of Kick.

▲ **Optional privacy**

Open when you're available – closed when you need to focus. Use the sliding door to visually signal your current work mode.

▲ **Move as needed**

Mobile tables provide convenient workspace where it's needed. Pull tables together for an impromptu meeting, then take one back to your own space to work on that big project.

▲ **Stack up, stack down**

Add or subtract structural stackers with minimal disruption, as privacy and other needs change within your workplace.

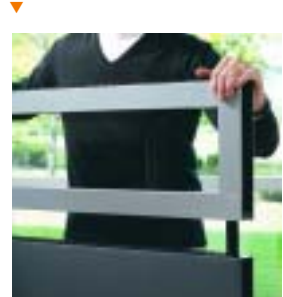

▲ **See-through privacy**

Keep panel heights lower and up-mount bins for storage – even on structural stackers. Bins and stackers provide privacy, while glass stackers help create openness.

▲ **surface materials**

Panel fabrics: Designtex About Face Y148 Coconut, Y159 Tangerine, Y162 Storm. Paint: 4799 Platinum. Laminates: 25T1 Winter on Maple, 275T Warm White. Let's B chairs: Bee 5E46 Nutmeg. Uno chair: Buzz2 5F02 Orange.



simply smart

Uncomplicated, easy-to-use parts simplify your furniture system management.

▲ **One connector**

A universal connector is used for inline, T, L or X panel connections, helping keep installation simple.



▲ **Built to last**

Tubular steel panel construction offers solid durability. Kick is backed by the Steelcase Limited Lifetime Warranty.

▲ **Change looks**

Interchangeable glass and perforated steel panels, removable panel skins and inserts allow you to change the look of your office with minimal disruption.

▲ **Ships assembled**

Panels ship fully assembled – even if the panel is segmented or monolithic.

▲ **surface materials**

Panel fabrics: Designtex About Face Y148 Coconut, Y159 Tangerine, Y162 Storm. Paint: 4799 Platinum. Laminate: 275T Warm White. Let's B chair: Bee 5E46 Nutmeg. Jenny lounge chair: Designtex Bsharp 2362-301. Jenny ottoman: Buzz2 5F02.

▲ **Kick variety**

Freestanding, open plan or private office, Kick offers a collection of solutions to meet your needs.



options



Tackable acoustical



Glass



Perforated steel



Fabric insert



Translucent insert



Laminate insert



Kick worksurfaces

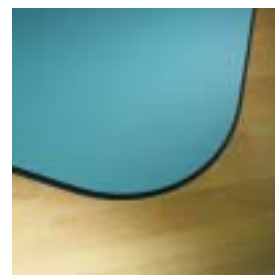

Universal laminate worksurfaces

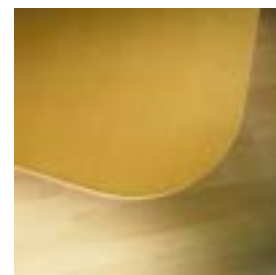

Universal wood veneer worksurfaces



Kick bin



Universal Curved Front Bin



Universal Curved Front Bin with wood door

laminates

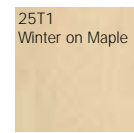

25T1 Winter on Maple

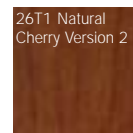

26T1 Natural Cherry Version 2



2150 Vanadium Fiber

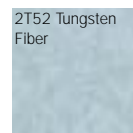

2152 Tungsten Fiber

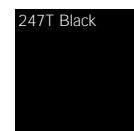

247T Black



273T Sand

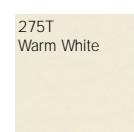

275T Warm White



286T Fog

paints

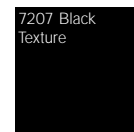

7207 Black Texture

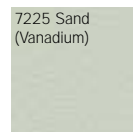

7225 Sand (Vanadium)



7236 Fog

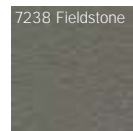

7238 Fieldstone



4798 Sterling

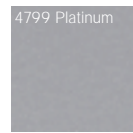

4799 Platinum

Surface materials

Standard Kick surface materials include 6 paint* choices and 8 laminate options. Over 46 families of vertical fabrics are available with Kick, Steelcase and DesignTex graded-in fabrics as well as Customer's Own Material.

See the Turnstone Specification Guide for more details.

*Note: Kick Freestanding furniture has 12 paint choices.

Panels

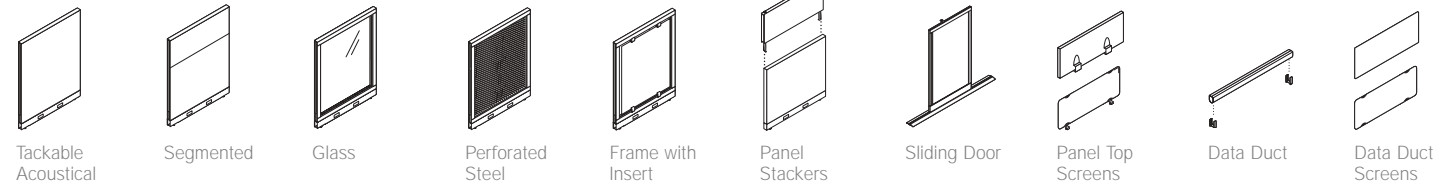

Worksurfaces

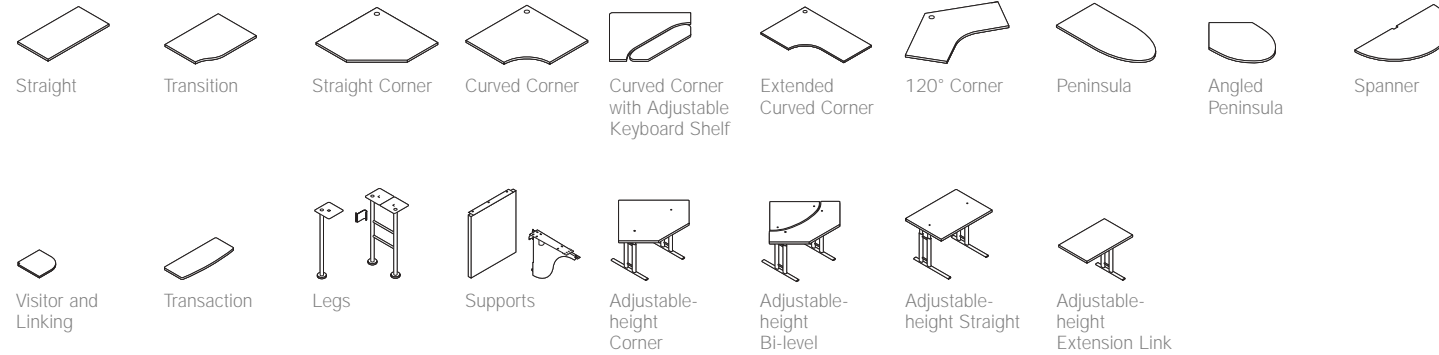

Overhead Storage

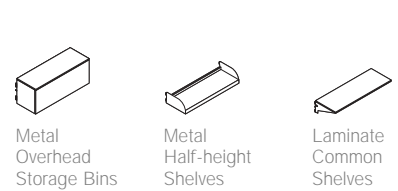

Turnstone Storage



Freestanding

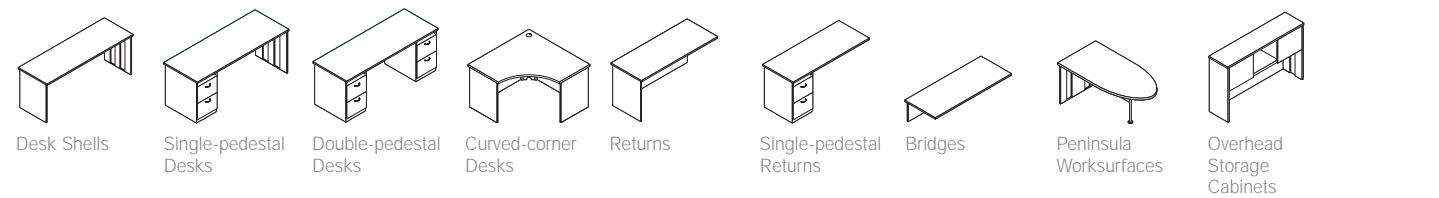

environmental

Recyclable

By weight, 95% of Kick is recyclable (depending on the configuration).



Reusable

Kick panels offer removable skins and inserts, which enable you to replace and update the look without replacing the entire panel — saving money as well as resources.

Reduced packaging

Boxless packaging, used whenever possible, reduces the amount of recycled cardboard needed for shipping and minimizes waste at the jobsite.

Keeping clean

Kick uses powder-coat paints which emit virtually no VOCs.

Friendly fabrics

The Designtex Environmental Impact Collection fabrics are designed to be used without chemical backings and are manufactured with processes that conserve the earth's resources. Engineered to be recycled, they are available to order on Turnstone products.

DESIGN
TEX

turnstone®

For more information, call your Steelcase/Turnstone representative at 1.800.333.9939 or visit us online at www.turnstonefurniture.com.

©2003 Steelcase Inc. All rights reserved.
Printed in U.S.A. on recycled paper. ♻️
Data subject to change.

Trademarks are the property of
Steelcase Development Corporation.

03-0003536 Turnstone Kick Brochure 12/03

