

Submitted Model No.: _____

Specific Features: _____

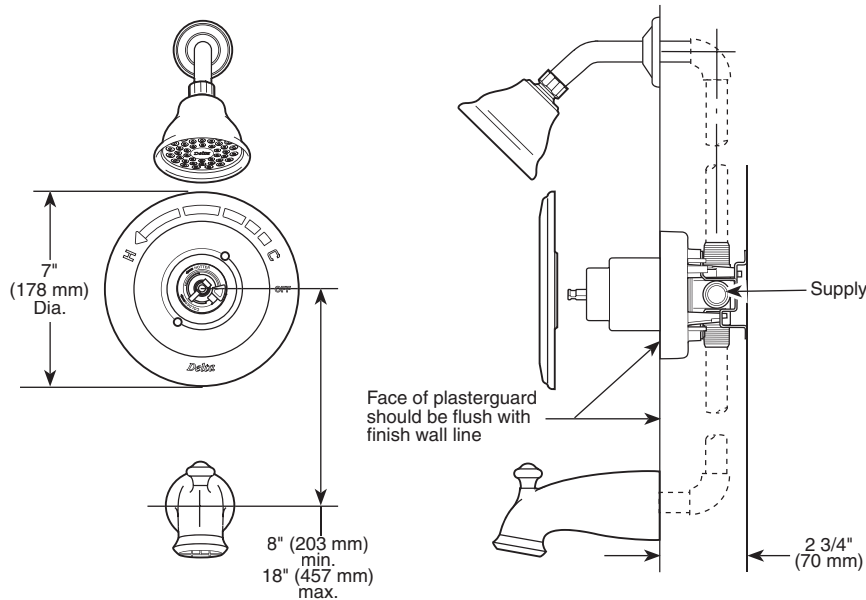

TUB AND SHOWER FAUCET TRIM

- Leland™ Bath Series
- Tub Only (T14178-LHP Series)
- Shower Only (T14278-LHP Series)
- Tub/Shower (T14478-LHP Series)

STANDARD SPECIFICATIONS:

- Monitor® 14 Series pressure balanced bath mixing valve with Scald-Guard®.
- Maintains a balanced pressure of hot and cold water even when a valve is turned on or off elsewhere in the system.
- For use with MultiChoice™ Universal rough valve body. (R10000 Series)
- Back-to-back installation capability.
- Solid brass fabricated body.
- Temperature only controlled with handle.
- Field adjustable to limit handle rotation into hot water zone.
- 120° maximum handle rotation.
- All parts replaceable from the front of the valve.
- LHP - less handle program - see recommended handles below.

WARRANTY

- Lifetime Faucet and Finish Limited Warranty to the original consumer purchaser to be free from defects in material and workmanship.
- 5 Year Limited Warranty for usage in all industrial, commercial and business applications.

COMPLIES WITH:

- ASME A112.18.1 / CSA B125.1
- ASSE 1016
- Indicates ADA compliance to ICC/ANSI A117.1



▲ = Specify Finish

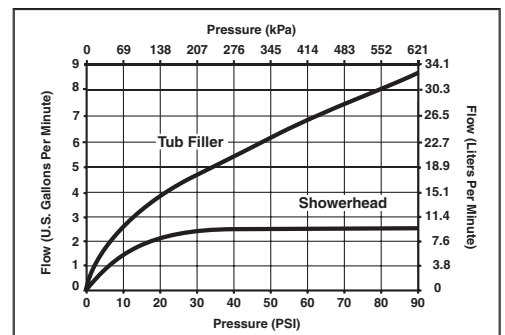
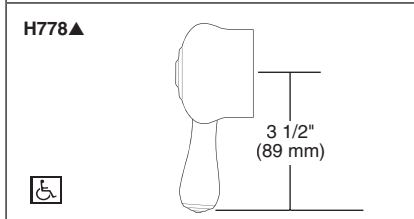
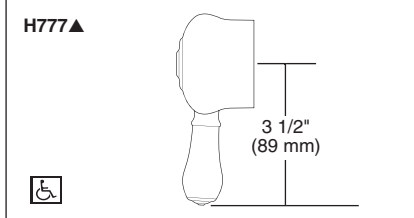
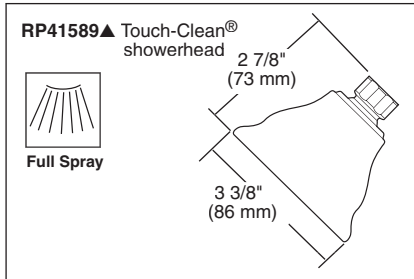
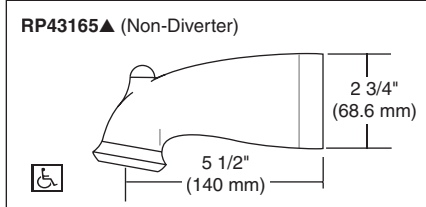
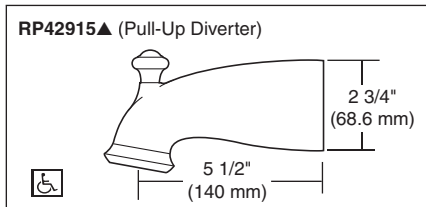

Indianapolis, Indiana 46280
 A Division of Masco Corporation of Indiana
 © 2006 Masco Corporation of Indiana

Delta reserves the right (1) to make changes in specifications and materials, and (2) to change or discontinue models, both without notice or obligation. Dimensions are for reference only. See current full-line price book for finish options and product availability.