

# San Francisco

Series



MARKET STREET

UNION SQUARE



# APCL-302.02

## Market Street

Designer - SEDAP



- NP
- MW
- SW
- RD
- BL
- OL
- EB
- SG
- SM
- PG
- PM
- CG
- CM

### Mounting

Ceiling mount on octagonal J-Box (4x4)

### Material

Fibre Reinforced Plaster™ and Polyethylene Terephthalate

### Lamp type (lamp not included)

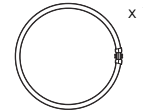

FC12T5 55W 2GX13  
Compact Fluorescent, Circular T5, 4-Pin

### Voltage and Ballast

- All our fluorescent lighting fixtures are available in 120 or 277 Volts
- All our ballasts are electronic and are less than 10% THD
- For 347 Volt ballast, please consult the factory
- For electronic dimming ballast, please consult the factory

### Dimensions (Diameter x Height)

20.9" x 3.1"

### Weight

16.1 lbs.

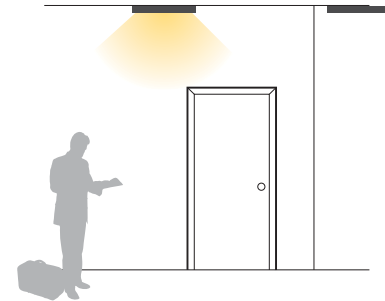
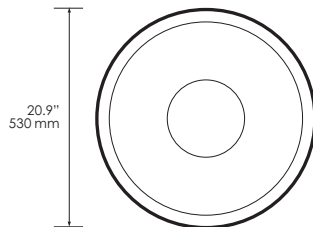

## HOW TO SPECIFY

SERIES	MODEL#	LAMP TYPE	VOLTAGE	FINISH														
APCL	302.02	→ _____	→ _____	→ _____														
		 FC12T5 55W	120 = 120 Volts 277 = 277 Volts	<table border="0"> <tr> <td>NP = NATURAL PLASTER</td> <td>SG = SILVER GLOSS</td> </tr> <tr> <td>MW = MATTE WHITE</td> <td>SM = SILVER MATTE</td> </tr> <tr> <td>SW = SATIN WHITE</td> <td>PG = PLATINUM GLOSS</td> </tr> <tr> <td>RD = RED</td> <td>PM = PLATINUM MATTE</td> </tr> <tr> <td>BL = BLUE</td> <td>CG = COPPER GLOSS</td> </tr> <tr> <td>OL = OLIVE</td> <td>CM = COPPER MATTE</td> </tr> <tr> <td>EB = EBONY</td> <td></td> </tr> </table>	NP = NATURAL PLASTER	SG = SILVER GLOSS	MW = MATTE WHITE	SM = SILVER MATTE	SW = SATIN WHITE	PG = PLATINUM GLOSS	RD = RED	PM = PLATINUM MATTE	BL = BLUE	CG = COPPER GLOSS	OL = OLIVE	CM = COPPER MATTE	EB = EBONY	
NP = NATURAL PLASTER	SG = SILVER GLOSS																	
MW = MATTE WHITE	SM = SILVER MATTE																	
SW = SATIN WHITE	PG = PLATINUM GLOSS																	
RD = RED	PM = PLATINUM MATTE																	
BL = BLUE	CG = COPPER GLOSS																	
OL = OLIVE	CM = COPPER MATTE																	
EB = EBONY																		
Architectural Plaster Ceiling																		

# APCL-304.02

## Union Square

Designer - SEDAP

- NP
- MW
- SW
- RD
- BL
- OL
- EB
- SG
- SM
- PG
- PM
- CG
- CM

### • Mounting

Ceiling mount on octagonal J-Box (4x4)

### • Material

Fibre Reinforced Plaster™ and Polyethylene Terephthalate

### • Lamp type (lamp not included)

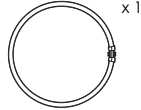

FC12T5 55W 2GX13  
Compact Fluorescent, Circular T5, 4-Pin

### • Voltage and Ballast

- All our fluorescent lighting fixtures are available in 120 or 277 Volts
- All our ballasts are electronic and are less than 10% THD
- For 347 Volt ballast, please consult the factory
- For electronic dimming ballast, please consult the factory

### • Dimensions (Length x Height x Depth)

20.9" x 20.9" x 3.1"

### • Weight

34.8 lbs.

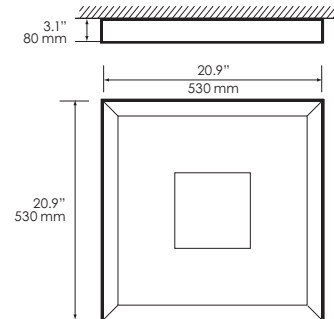
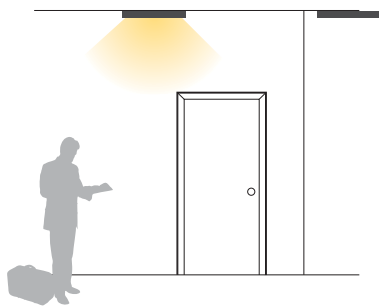

## HOW TO SPECIFY

SERIES	MODEL#	LAMP TYPE	VOLTAGE	FINISH														
APCL	304.02	→ _____	→ _____	→ _____														
		 FC12T5 55W	120 = 120 Volts 277 = 277 Volts	<table border="0"> <tr> <td>NP = NATURAL PLASTER</td> <td>SG = SILVER GLOSS</td> </tr> <tr> <td>MW = MATTE WHITE</td> <td>SM = SILVER MATTE</td> </tr> <tr> <td>SW = SATIN WHITE</td> <td>PG = PLATINUM GLOSS</td> </tr> <tr> <td>RD = RED</td> <td>PM = PLATINUM MATTE</td> </tr> <tr> <td>BL = BLUE</td> <td>CG = COPPER GLOSS</td> </tr> <tr> <td>OL = OLIVE</td> <td>CM = COPPER MATTE</td> </tr> <tr> <td>EB = EBONY</td> <td></td> </tr> </table>	NP = NATURAL PLASTER	SG = SILVER GLOSS	MW = MATTE WHITE	SM = SILVER MATTE	SW = SATIN WHITE	PG = PLATINUM GLOSS	RD = RED	PM = PLATINUM MATTE	BL = BLUE	CG = COPPER GLOSS	OL = OLIVE	CM = COPPER MATTE	EB = EBONY	
NP = NATURAL PLASTER	SG = SILVER GLOSS																	
MW = MATTE WHITE	SM = SILVER MATTE																	
SW = SATIN WHITE	PG = PLATINUM GLOSS																	
RD = RED	PM = PLATINUM MATTE																	
BL = BLUE	CG = COPPER GLOSS																	
OL = OLIVE	CM = COPPER MATTE																	
EB = EBONY																		
Architectural Plaster Ceiling																		

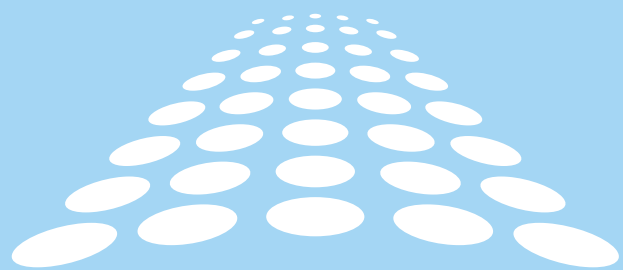

sedap

n o r t h a m e r i c a

[www.sedap-na.com](http://www.sedap-na.com)